

Catálogo
Catalogue
Catálogo

2025

Iluminación
Lighting
Iluminação

ILUMINACIÓN **LED** PROFESIONAL
PROFESSIONAL **LED** LIGHTING
ILUMINAÇÃO **LED** PROFISSIONAL

FILUX
www.filux.com

ÍNDICE INDEX ÍNDICE



Campanas
High bays
Campânulas

pag. 4

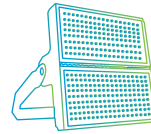

Proyectores
Floodlights
Projetores

pag. 22

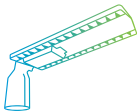

Farolas
Streetlights
Viárias

pag. 40



Luminarias estancas
Waterproof luminaires
Luminárias estanques

pag. 54



Tubos
Tubes
Tubos

pag. 60



Regletas
Battens
Luminárias

pag. 64



Paneles
Panels
Painéis

pag. 70



Downlights
Downlights
Downlights

pag. 78



Plafones led
Led ceiling lights
Luzes de teto led

pag. 88



Sensores
Sensors
Sensores

pag. 100



Luminaria de emergencia
Emergency luminaire
Luminária de emergência

pag. 109

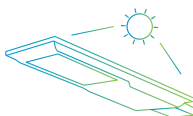

Luminaria solar
Solar luminaire
Luminária solar

pag. 120



Tiras
Strips
Fitas

pag. 126



Bombillas
Bulbs
Lâmpadas

pag. 144

SOBRE NÓS **ABOUT US**

SOBRE NOSOTROS

Fabricamos a medida
On demand custom
Fabricamos à medida

pag. 162

Situación geográfica
Geographic situation
Situação geográfica

pag. 163

Nuestros servicios
Our services
Serviços

pag. 164

Estudios lumínicos
Light tests
Estudos luminotécnicos

pag. 166

Certificaciones
Certifications
Certificações

pag. 167

Avance tecnológico
Technological advance
Avanço tecnológico

pag. 168

Ventajas de la iluminación led
Advantages of led lighting
Vantagens da iluminação led

pag. 169

Sé nuestro distribuidor
Be our distributor
Seja nosso distribuidor

pag. 170

Información catálogo
Catalogue info
Informação do catálogo

pag. 172

Terminología
Terminology
Terminologia

pag. 174

Temperatura de color
Color temperature
Temperatura de cor

pag. 176

Condiciones generales
General conditions
Condições gerais

pag. 177





Campanas
High bays
Campânulas



CAMPANAS | HIGH BAYS | CAMPÁNULAS

LED PRO UFO HIGH BAY. Meanwell

La campana LED PRO UFO Filux cuenta con un diseño exclusivo y compacto que permite disipar el calor de forma constante y eficaz. Las Campanas LED PRO UFO Filux están fabricadas según los estándares de calidad más exigentes y ofrecen una garantía de 5 años. Las Campanas LED PRO UFO Filux presentan una gran resistencia.

Industrial LED PRO UFO high bays by Filux boasts a unique and compact design allowing to dissipate heat efficiently and constantly. LED PRO UFO Filux High bays are manufactured to the highest quality standards and offer a 5 year warranty. LED PRO UFO Filux High bays have a great resistance.

A campânula LED PRO UFO Filux tem um design exclusivo e compacto que dissipa o calor de maneira constante e eficaz. As campânulas LED PRO UFO Filux são fabricados atendendo aos mais altos padrões de qualidade e oferecem uma garantia de 5 anos. As campânulas Filux LED PRO UFO são muito resistentes.



5
YEAR
WARRANTY

50,000H

CRI
>80

120°

MEANWELL

PF
>0,95

IP65

4KV

IK09

LUMILEDS

-40° | +60°

1 PCS

SKU	Family	mm	Kg	Power	C.Temp	LM/W	Lumens	Input	Reg.	€*
F6018	FT-6100	191,40	4	100W	5.000K	160	16.000	100-240V, 50/60Hz	0-10V	158,00 €
F6019	FT-6150	193,88	4,3	150W			24000			166,20 €
F6020	FT-6200	198,50	4,4	200W			32.000			208,31 €

*Ecorae incluida | included | incluída
* IVA no incluido | VAT not included | IVA não incluído



Fotometría | Photometry | Fotometria

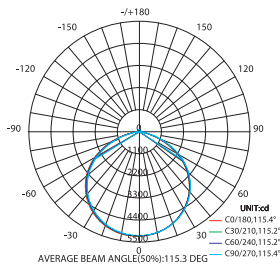

120°
 Ángulo apertura
 Beam angle
 Ângulo de abertura

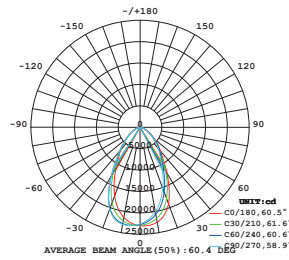

60°
 Lente de ángulo apertura
 Beam angle lens
 Lente de Ângulo de abertura

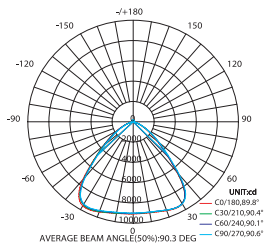

90°
 Lente de ángulo apertura
 Beam angle lens
 Lente de ângulo de abertura

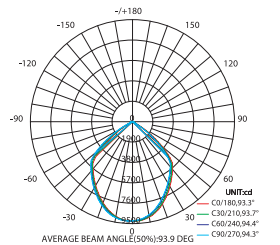

90° Ugr19 Ufo
 Cubierta reflectora
 Reflective cover
 Capa reflectora

LED PRO UFO HIGH BAY. Meanwell

Accesorios | Accessories | Acessórios

*Ecoraee incluida | included | incluída

* IVA no incluido | VAT not included | IVA não incluído



FT-6000/F6011

72,86 €*

Kit base + sensor de movimiento Base kit + motion sensor Kit base + Sensor de movimento	Para/for: F6018 F6019 F6020
-----------------------------------------------------------------------------------------------	--------------------------------------



FT-3000/F3015

14,05 €*

Protector sobre tensión Philips SP1 Philips voltage protector SP1 Protetor contra sobretensões Philips SP1	Para/for: F6018 F6019 F6020
------------------------------------------------------------------------------------------------------------------	--------------------------------------



FT-6000/F6028

5,90 €*

Lente ángulo de apertura 60° 60° beam angle lens Lente ângulo de abertura de 60°	Para/for: F6018 F6019 F6020
----------------------------------------------------------------------------------------	--------------------------------------



FT-6000/F6029

5,90 €*

Lente ángulo de apertura 90° 90° beam angle lens Lente ângulo de abertura de 90°	Para/for: F6018 F6019 F6020
----------------------------------------------------------------------------------------	--------------------------------------



FT-6000/F6513

46,83 €*

Cubierta reflectora Reflective cover Cobertura reflectora (Pc 90° Ugr19 UFO)	Ø 480mm
---------------------------------------------------------------------------------------	---------



FT-6000/F6027

9,41 €*

Soporte ajustable superficie Surface adjustable support Suporte superfície ajustável	Para/for: F6018 F6019 F6020
--------------------------------------------------------------------------------------------	--------------------------------------



FT-6000/F6032

28,32 €*

Conversor DALI - PWM DALI converter - PWM Conversor DALI - PWM	Para/for: F6018 F6019 F6020
----------------------------------------------------------------------	--------------------------------------



FT-2000/F2054

3,21 €*

Conector conexión rápida Quick connect connector Conector de ligação rápida	IP68
-----------------------------------------------------------------------------------	------



FT-2000/F2055

7,60 €*

T conexión rápida T quick connection Ligação rápida T	Para/for: F6018 F6019 F6020
-------------------------------------------------------------	--------------------------------------



FT-6000/F6031

247,01 €*

Kit de emergencia Emergency kit Kit de emergência	Para/for: F6018 F6019 F6020
---------------------------------------------------------	--------------------------------------



FT-6000/F6010

16,30 €*

Kit base + sensor luz diurna Base kit + daylight sensor Kit base + sensor de luz	Para/for: F6018 F6019 F6020
----------------------------------------------------------------------------------------	--------------------------------------

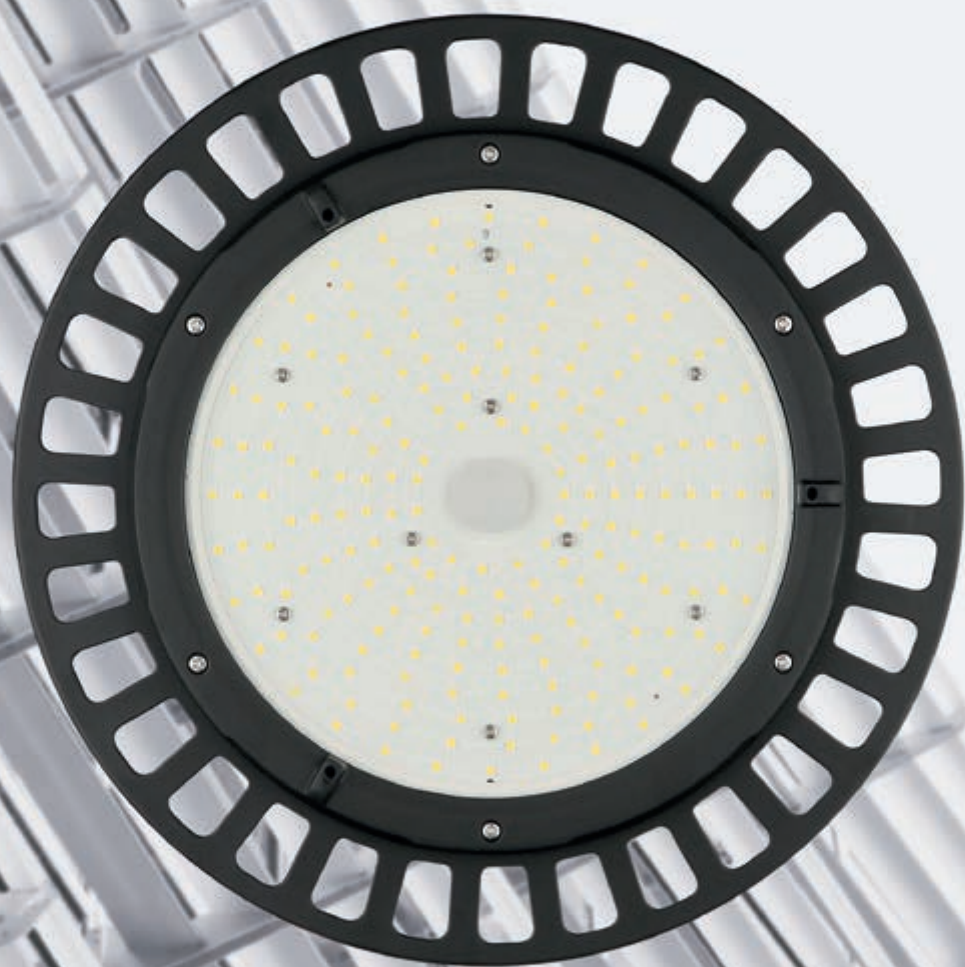

LED PRO UFO HIGH BAY. Philips

La campana LED PRO UFO Filux cuenta con un diseño exclusivo y compacto que permite disipar el calor de forma constante y eficaz. Las Campanas LED PRO UFO Filux están fabricadas según los estándares de calidad más exigentes y ofrecen una garantía de 5 años. Las Campanas LED PRO UFO Filux presentan una gran resistencia.

Industrial LED PRO UFO high bays by Filux boasts a unique and compact design allowing to dissipate heat efficiently and constantly. LED PRO UFO Filux High bays are manufactured to the highest quality standards and offer a 5 year warranty. LED PRO UFO Filux High bays have a great resistance.

A campânula LED PRO UFO Filux tem um design exclusivo e compacto que dissipa o calor de maneira constante e eficaz. As campânulas LED PRO UFO Filux são fabricados atendendo aos mais altos padrões de qualidade e oferecem uma garantia de 5 anos. As câmpanulas Filux LED PRO UFO são muito resistentes.



5
YEAR
WARRANTY

50.000H

120°



PF
>0,95

IP65

4KV

IK08



-40° | +60°

1 PCS



SKU	Family	mm	Kg	Power	C.Temp	LM/W	Lumens	Input	Reg.	€*
-----	--------	----	----	-------	--------	------	--------	-------	------	----

A B

*Ecoraee incluída | included | incluída

* IVA no incluído | VAT not included | IVA não incluído

F6070	FT-6100	164	Ø 260	2,03	100W	5.000K	170	220-240V, 50/60Hz	1-10V +AUX	17.000	90,96 €
F6071	FT-6150	167	Ø 290	2,35	150W					25.500	106,43 €
F6072	FT-6200	170	Ø 320	2,65	200W					34.000	124,45 €
F6073	FT-6240				240W					40.800	132,87 €

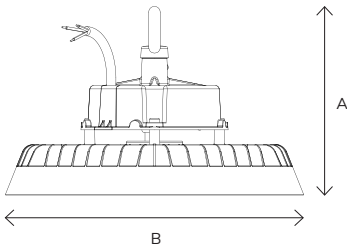

LED PRO UFO HIGH BAY. Philips

Las campanas LED PRO UFO Filux F6043, F6044, F6045 cuentan con Driver Philips y con un diseño exclusivo y compacto que permite disipar el calor de forma constante y eficaz. Las Campanas LED PRO UFO Filux están fabricadas según los estándares de calidad más exigentes y ofrecen una garantía de 5 años. Las Campanas LED Filux presentan una gran resistencia.

Industrial LED PRO UFO Filux F6043, F6044, F6045 high bays have a Philips driver and boasts a unique and compact design allowing to dissipate heat efficiently and constantly. LED PRO UFO Filux High bays are manufactured to the highest quality standards and offer a 5 year warranty. LED Filux High bays have a great resistance.

As campânuas LED PRO UFO Filux F6043, F6044, F6045 têm um driver Philips e possui um design exclusivo e compacto que dissipa o calor de maneira constante e eficaz. As campânuas LED PRO UFO Filux são fabricados atendendo aos mais altos padrões de qualidade e oferecem uma garantia de 5 anos. As câmpanulas Filux LED são muito resistentes.



5
YEAR
WARRANTY

50.000H

CRI
>80

120°

PHILIPS

PF
>0,95

IP65

4KV

IK08

LUMILEDS

-40° | +60°

1 PCS

SKU	Family	mm	Kg	Power	C.Temp	LM/W	Lumens	Input	Reg.	€*
		A	B							
F6043	FT-6100	184	Ø 310	2,2	100W	5.000K	16.000	220-240V, 50/60Hz	1-10V	92,51 €
F6044	FT-6150			2,3	150W		24.000			107,65 €
F6045	FT-6200	192	Ø 350	2,9	200W		32.000			127,32 €
F6052	FT-6300	229	Ø 400	6,8	300W		48.000			330,03 €

*Ecorae incluída | included | incluída
* IVA no incluído | VAT not included | IVA não incluído

12

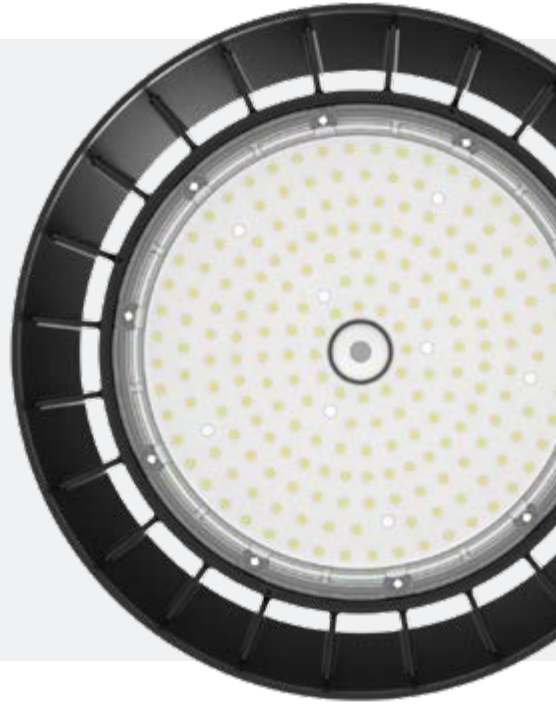

Fotometría | Photometry | Fotometria

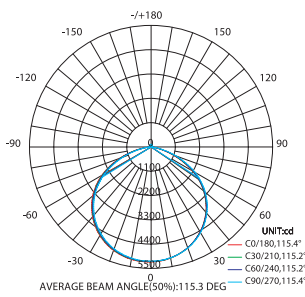

120°

Ángulo apertura
 Beam angle
 Ângulo de abertura

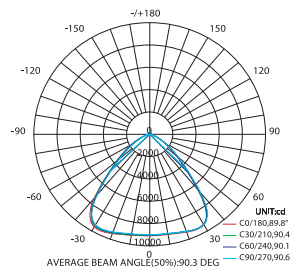

90°

Lente de ángulo apertura
 Beam angle lens
 Lente de Ângulo de abertura

LED PRO UFO HIGH BAY. Philips

Accesorios | Accessories | Acessórios

*Ecoraee incluida | included | incluída

* IVA no incluido | VAT not included | IVA não incluído



FT-6000/F6010

16,30 €*

Kit base + sensor luz diurna
Base kit + daylight sensor
Kit base + sensor de luz



FT-6000/F6011

72,86 €*

Kit base + sensor de movimiento
Base kit + motion sensor
Kit base + Sensor de movimento



FT-3000/F3015

14,05 €*

Protector sobre tensión Philips SP1
Philips voltage protector SP1
Protetor contra sobretensões Philips SP1



FT-2000/F2054

3,21 €*

Conector conexión rápida
Quick connect connector
Conector de ligação rápida

IP68



FT-2000/F2055

7,60 €*

T conexión rápida
T quick connection
Ligação rápida T



FT-6000/F6053

246,04 €*

Kit de emergencia AC 20W
Emergency kit AC 20W
Kit de emergência AC 20W



FT-6000/F6046

10,45 €*

Soporte ajustable de superficie: F6043-44
Base kit + daylight sensor: F6043-44
Montagem superfície ajustável: F6043-44



FT-6000/F6047

6,56 €*

Óptica 60° para UFO F6043-44
60° beam angle lens for F6043-44
Kit base + sensor de luz para: F6043-44



FT-6000/F6048

6,56 €*

Óptica 90° para UFO F6043-44
90° beam angle lens for F6043-44
Lente ângulo de abertura 60°: F6043-44



FT-6000/F6049

10,45 €*

Soporte ajustable de superficie: F6045
Base kit + daylight sensor: F6045
Montagem superfície ajustável: F6045



FT-6000/F6050

6,56 €*

Óptica 60° para UFO F6045
60° beam angle lens for F6045
Kit base + sensor de luz para: F6045



FT-6000/F6051

6,56 €*

Óptica 90° para UFO F6045
90° beam angle lens for F6045
Lente ângulo de abertura 60°: F6045

LED PRO UFO HIGH BAY. Philips

Accesorios | Accessories | Acessórios

*Ecoraee incluída | included | incluída

* IVA no incluído | VAT not included | IVA não incluído



FT-6000/F6077

6,04 €*

Lente ángulo de apertura 60°
60° beam angle lens
Lente ángulo de abertura de 60°

Para/for:
F6070
F6071
F6074



FT-6000/F6078

6,04 €*

Lente ángulo de apertura 90°
90° beam angle lens
Lente ángulo de abertura de 90°

Para/for:
F6070
F6071
F6074



FT-6000/F6076

13,07 €*

Soporte ajustable superficie
Rosca/Thread/Fio: Ø 9,5mm
Surface adjustable support
Suporte superfície ajustável

Para/for:
F6070
F6071
F6072
F6073
F6074



FT-6000/F6079

6,88 €*

Lente ángulo de apertura 60°
60° beam angle lens
Lente ángulo de abertura de 60°

Para/for:
F6072
F6073



FT-6000/F6080

6,88 €*

Lente ángulo de apertura 90°
90° beam angle lens
Lente ángulo de abertura de 90°

Para/for:
F6072
F6073



FT-6000/F6033

29,66 €*

Conversor DALI - LF-SCD10B 1/10V+AUX
DALI converter - LF-SCD10B 1/10V+AUX
Conversor DALI - LF-SCD10B 1/10V+AUX

LED VALUE UFO HIGH BAY

La campana LED PRO UFO Filux cuenta con un diseño exclusivo y compacto que permite disipar el calor de forma constante y eficaz. Las Campanas LED PRO UFO Filux están fabricadas según los estándares de calidad más exigentes. Las Campanas LED PRO UFO Filux presentan una gran resistencia.

Industrial LED PRO UFO high bays by Filux boasts a unique and compact design allowing to dissipate heat efficiently and constantly. LED PRO UFO Filux High bays are manufactured to the highest quality standards. LED PRO UFO Filux High bays have a great resistance.

A campânula LED PRO UFO Filux tem um design exclusivo e compacto que dissipa o calor de maneira constante e eficaz. As campânulas LED PRO UFO Filux são fabricados atendendo aos mais altos padrões de qualidade. As câmpanulas Filux LED PRO UFO são muito resistentes.

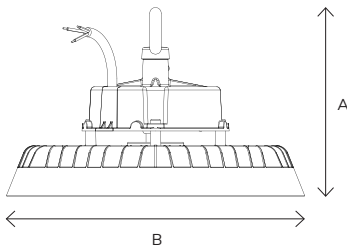

3*
YEAR
WARRANTY

50.000H



120°

PF
>0,95

POWER
SELECTABLE



IP65



SOSEN



IK08

-25° | +45°



1 PCS



SKU	Family	mm	Kg	Power Selection	C.Temp	LM/W	Lumens	Input	€*	
		A	B							
F6074	FT-6200	167	Ø 290	2,35	100W	CCT 4.000K 5.000K 6.000K	150	15.000	220-240V 50/60Hz	83,61 €
					150W			22.500		
					200W			30.000		

*Ecoraee incluida | included | incluída

* IVA no incluido | VAT not included | IVA não incluído

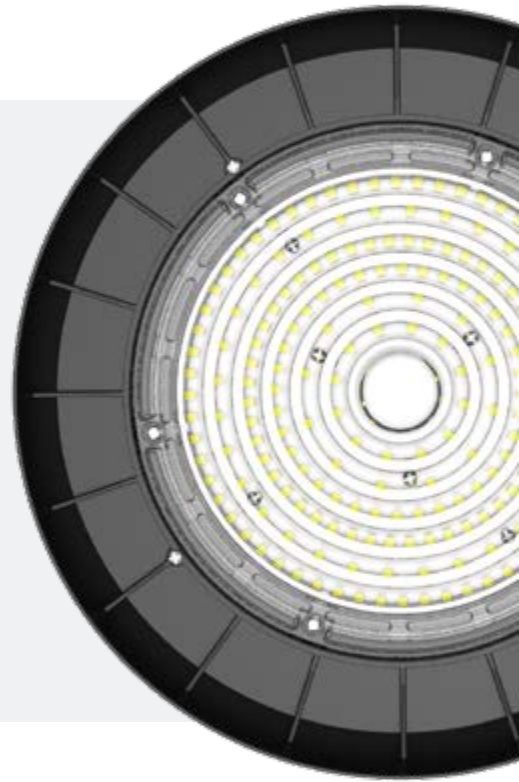

Con selector de cambio de potencia y de temp. de color
With power and color temperature change selector
com seletor de mudança de potência e temperatura de cor

5
YEAR
WARRANTY

F6075

20€*



5 de ampliación de garantía para F6074
5 year warranty extension to F6074
Extensão de garantia de 5 anos para F6074

Accesorios | Accessories | Acessórios

*Ecoraee incluida | included | incluída

* IVA no incluido | VAT not included | IVA não incluído



FT-6000/F6077

6,04 €*

Lente ángulo de apertura 60°
60° beam angle lens
Lente ángulo de abertura de 60°

Para/for:
F6070
F6071
F6074



FT-6000/F6078

6,04 €*

Lente ángulo de apertura 90°
90° beam angle lens
Lente ángulo de abertura de 90°

Para/for:
F6070
F6071
F6074



FT-2000/F2054

3,21 €*

Conector conexión rápida
Quick connect connector
Conector de ligação rápida

IP68

LED VALUE UFO HIGH BAY

Las campanas LED PRO UFO Filux con un diseño exclusivo y compacto que permite disipar el calor de forma constante y eficaz, presentan una gran resistencia. Están fabricadas según los estándares de calidad más exigentes y ofrecen una garantía de 3 años.

The LED PRO UFO Filux hoods have a unique, compact design for constant and efficient heat dissipation and are highly resistant. They are manufactured to the highest quality standards and come with a 3-year guarantee.

As campânulas LED PRO UFO Filux têm um design único e compacto para uma dissipação de calor constante e eficaz e são altamente resistentes. São fabricados com os mais elevados padrões de qualidade e têm uma garantia de 3 anos.

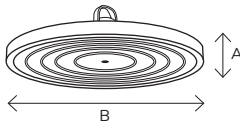

3
YEAR
WARRANTY

50.000H

CRI
>80

110°

PF
>0,95

**POWER
SELECTABLE**

IP65

3KV

IK06

-25° | +45°

1 PCS



Con selector de cambio de potencia
With power selector switch
Com interruptor de seleção de potência



SKU	Family	mm	Kg	Power Selection	C.Temp	LM/W	Lumens	Input	€*
		A	B						
F6060	FT-6200	94	Ø 381	2.2	5.000K	155	15.500	220-240V 50/60Hz	84.60 €
						150	22.500		
						140	28.000		

*Ecorae incluida | included | incluída
* IVA no incluido | VAT not included | IVA não incluído

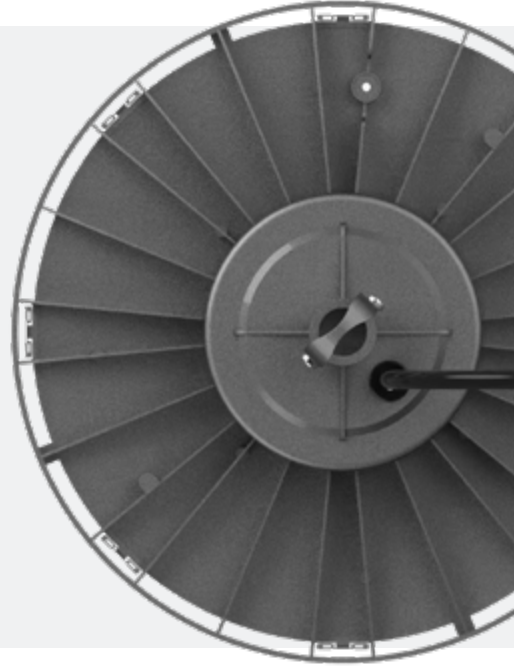

Accesorios | Accessories | Acessórios

*Ecoraee incluída | included | incluída
 * IVA no incluído | VAT not included | IVA não incluído



F6061 **17,91 €***

Cubierta reflectora aluminio para F6060
 Aluminium reflector cover for F6060
 Cobertura reflectora em alumínio para F6060



FT-2000/F2054 **3,21 €***

Conector conexión rápida
 Quick connect connector
 Conector de ligação rápida

IP68



FT-2000/F2055 **7,60 €***

T conexión rápida
 T quick connection
 Ligação rápida T

LED DESIGN HIGH BAY

Las campanas LED PRO UFO Filux con un diseño exclusivo y compacto que permite disipar el calor de forma constante y eficaz, presentan una gran resistencia. Están fabricadas según los estándares de calidad más exigentes y ofrecen una garantía de 5 años.

The LED PRO UFO Filux hoods have a unique, compact design for constant and efficient heat dissipation and are highly resistant. They are manufactured to the highest quality standards and come with a 5-year guarantee.

As campânulas LED PRO UFO Filux têm um design único e compacto para uma dissipação de calor constante e eficaz e são altamente resistentes. São fabricados com os mais elevados padrões de qualidade e têm uma garantia de 5 anos.



5
YEAR
WARRANTY

50.000H

CRI
>80

85°

PF
>0,95

IP20

LIFUD

-30° | +50°

1 PCS

**POWER
SELECTABLE**



SKU	Family	mm	Kg	Power Selection	C.Temp	LM/W	Lumens	Input	€*
-----	--------	----	----	-----------------	--------	------	--------	-------	----

A B

*Ecoraee incluida | included | incluída
* IVA no incluido | VAT not included | IVA não incluído

F6062	FT-6080	456	Ø 330	3,2	22W	CCT 3.000K 4.000K 5.000K	140	3.080	100-277V 50/60Hz	119,41 €
					40W			5.600		
					60W			8.400		
					80W			11.200		
F6063	FT-6080	COVER PC UGR <19 PARA F6062							30,12 €	
F6064	FT-6080	COVER ALUMINIO UGR <19 PARA F6062							18,47 €	
F6065	FT-6080	KIT DE SUSPENSIÓN PARA F6062							13,42 €	



Con selector de cambio de potencia y de temp. de color
With power and color temperature change selector
Com seletor de mudança de potência e temperatura de cor

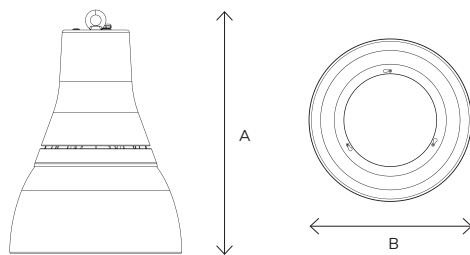

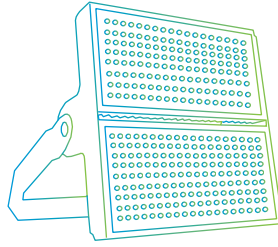

Proyectores
Floodlights
Projetores



PROYECTORES | FLOODLIGHTS | PROJETORES

LED PRO SPORT



SKU		Lens	€*	mm			kg	Lumens	C.Temp	Input
				A	B	C				
F85201		30°	447,28 €	230	420	110	5	42.000	5.000K	100-305V, 50/60Hz
F85202	300W proyector deportivo con soporte	45°	425,17 €							
F85203	300W sport floodlight with bracket	60°	447,28 €							
F85204	Projeção desportiva de 300 W com suporte	90°	447,28 €							
F85205		30°	905,68 €	470	420	110	11	84.000		
F85206	600W proyector deportivo con soporte	45°	861,46 €							
F85207	600W sport floodlight with bracket	60°	905,68 €							
F85208	Projeção desportiva de 600W com suporte	90°	905,68 €							
F85209		30°	1.311,65 €	720	420	110	16	126.000		
F85210	900W proyector deportivo con soporte	45°	1.245,31 €							
F85211	Module 900W sport floodlight with bracket	60°	1.311,65 €							
F85212	Projeção desportiva de 900W com suporte	90°	1.311,65 €							
F85213		30°	1.713,09 €	940	420	110	22	168.000		
F85214	1200W proyector deportivo con soporte	45°	1.624,64 €							
F85215	1200W sport floodlight with bracket	60°	1.713,09 €							
F85216	Projeção desportiva de 1200W com suporte	90°	1.713,09 €							

*Ecorae incluida | included | incluída
 * IVA no incluido | VAT not included | IVA não incluído



0-10V

PF
>0,93



SMD



20KV



IK10



140LM/W

5
YEAR
WARRANTY



50.000H

CRI
>80



MEANWELL



LUMILEDS



IP66

Producto desmontado necesita ensamblaje
Disassembled product needs assembly
Produto desmontado necessita de montagem



Es el sustituto perfecto para la sustitución de los focos en campos de fútbol, aeropuertos y puertos. Se puede inclinar para dirigir la luz en función de las necesidades del momento. El ángulo de apertura resulta muy adecuado como elemento de iluminación general.

It's the perfect substitute for the replacement of the floodlights in soccer stadiums, airports and ports. It can be tilted to direct the light according to the needs of the moment. The opening angle is very suitable as a general lighting element.

É a solução perfeita para utilização em campos de futebol, aeroportos e portos. Permite a orientação do feixe de luz. O ângulo de abertura é um elemento na iluminação geral.

Fotometrías | Photometries | Fotometrias

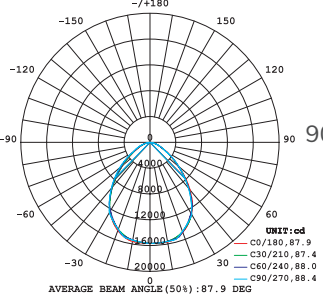
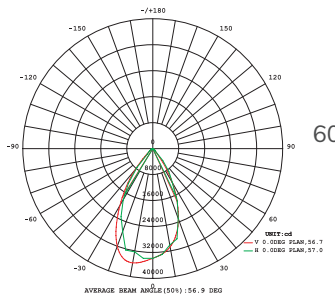
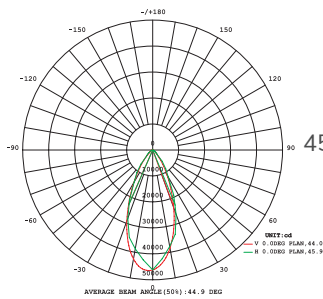
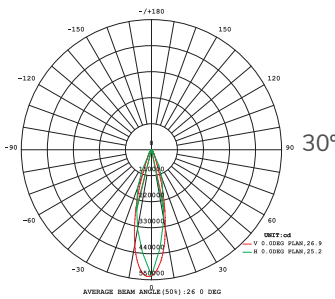

LED PRO SPORT

Componentes | Components | Componentes

*Ecoraee incluída | included | incluída
 * IVA no incluido | VAT not included | IVA não incluído



FT-8500/F8515 **22,11 €***

Lente 30° para módulo 300W
 30° lens for module 300W
 Lente de 30° para módulo 300W



FT-8500/F8516 **22,11 €***

Lente 60° para módulo 300W
 60° lens for module 300W
 Lente de 60° para módulo 300W



FT-8500/F8517 **22,11 €***

Lente 90° para módulo 300W
 90° lens for module 300W
 Lente de 90° para módulo 300W



F8511 **92,69 €***

Soporte proyector deportivo 300W
 Support sport floodlight 300W
 Suporte projetor desportivo 300W



F8512 **196,50 €***

Soporte proyector deportivo 600W
 Support sport floodlight 600W
 Suporte projetor desportivo 600W



F8513 **247,88 €***

Soporte proyector deportivo 900W
 Support sport floodlight 900W
 Suporte projetor desportivo 900W



F8514 **294,73 €***

Soporte proyector deportivo 1200W
 Support sport floodlight 1200W
 Suporte projetor desportivo 1200W



F8520 **332,48 €***

Módulo 300W 45°
 Module 300W 45°
 Modulo 300W 45°

Accesorios | Accessories | Acessórios

*Ecorae incluida | included | incluída
 * IVA no incluido | VAT not included | IVA não incluído



FT-8500/F8518 **18,55 €***

Visera modular para módulo 300W
 Metallic reflector for module 300W
 Viseira modular para módulo 300W



FT-2000/F2054 **3,21 €***

Conector conexión rápida
 Quick connect connector
 Conector de ligação rápida

IP68



FT-2000/F2055 **7,60 €***

T conexión rápida
 T quick connection
 Ligação rápida T



FT-6000/F6032 **28,32 €***

Conversor DALI - PWM
 DALI converter - PWM
 Conversor DALI - PWM



FT-8500/F8519 **64,96 €***

Sistema laser de replanteo iluminación
 Laser system for illumination stakeout
 Sistema laser para iluminação de piquetagem

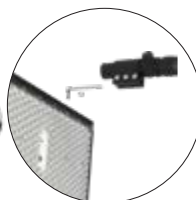

LED LINEAR LIGHT

La revolución de la iluminación con la luminaria lineal FILUX, una luminaria lineal de 200W y 140lm/W, y que viene con una lente asimétrica. Además, cuenta con una garantía de 5 años y una clasificación IP65 para resistencia al agua y al polvo.

The lighting revolution with the FILUX linear luminaire, a 200W and 140lm/W linear luminaire, and that comes with an asymmetrical lens. Plus, it comes with a 5-year warranty and an IP65 rating for water and dust resistance.

A revolução da iluminação com a luminária linear FILUX, uma luminária linear de 200W e 140lm/W, e que vem com lente assimétrica. Além disso, ele vem com garantia de 5 anos e classificação IP65 para resistência à água e poeira.



5
YEAR
WARRANTY

50.000H

CRI
>80

105°X90°



PF
>0,95



IP66



3KV



IK07



140LM/W



SMD



1 PCS



SKU	Family	mm			kg	Power	C.Temp	Lumens	Input	€*
		A	B	C						
F4730	FT-4720	685	136	135	3,8	200W	5.000K	28.000	100-277V 50/60HZ	113,87 €

*Ecorae incluida | included | incluída
* IVA no incluído | VAT not included | IVA não incluído

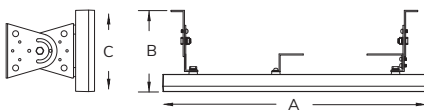

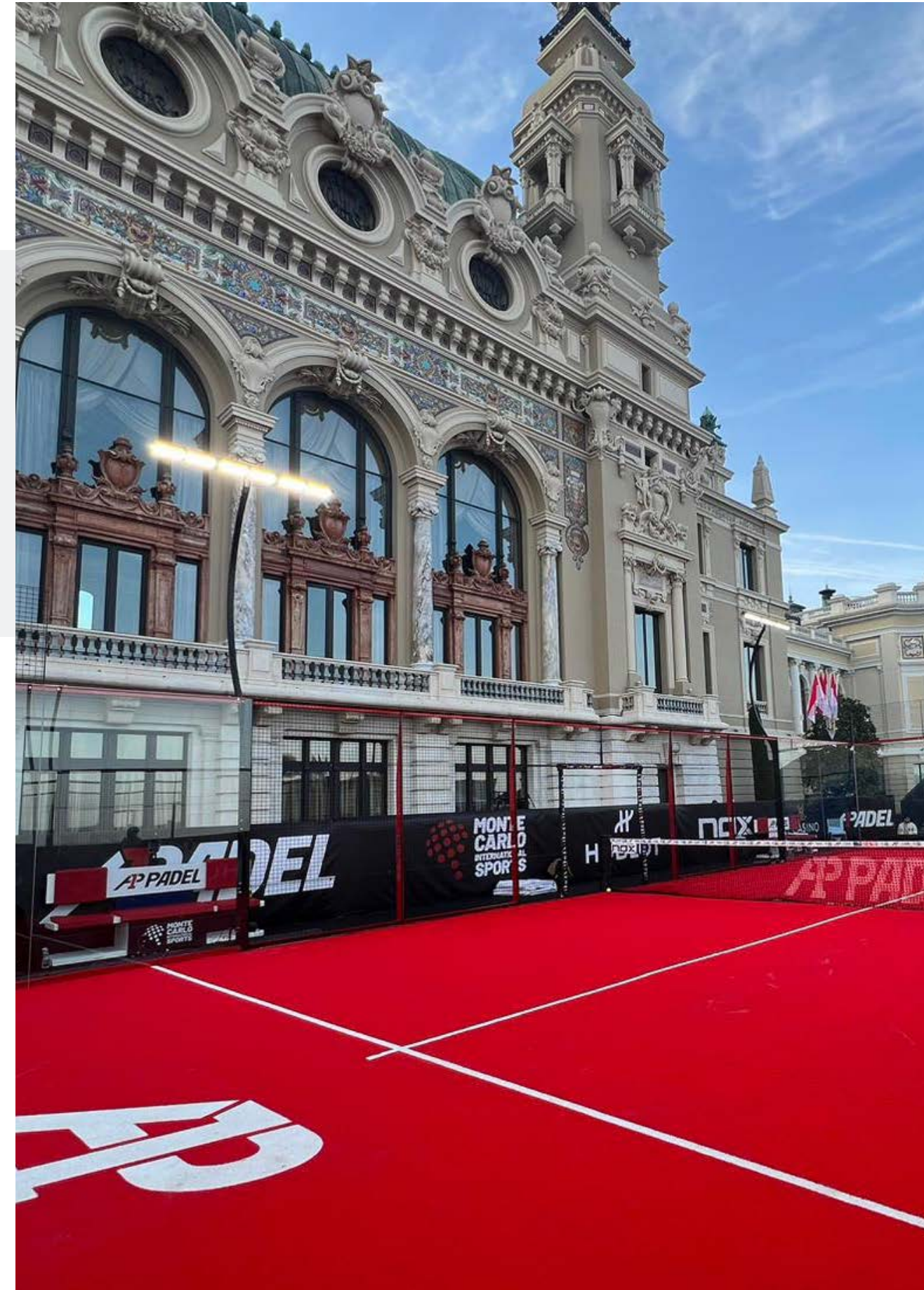

AP PADEL

MONTE CARLO INTERNATIONAL SPORTS

PADEL

AP PADEL

AP

LED LINEAR LIGHT

Las Campanas Lineales LED Filux son el remplazo ideal de las tradicionales luminarias de vapor de sodio o mercurio de alta presión. Aporta un ahorro energético y permite reducir los costes de mantenimiento. No tienen elementos altamente contaminantes como el mercurio siendo totalmente ecológica.

The Filux LED Linear high bays are ideal replacement for traditional high pressure mercury or sodium vapor lamps. It provides energy savings and reduces maintenance costs. It does not have highly polluting elements like mercury being, totally ecological.

As câmpânulas lineares de LED Filux permitem a substituição ideal das luminárias tradicionais de vapor de sódio ou demercúrio de alta pressão. Permitem uma forte poupança de energia permitindo forte redução nos custos de manutenção. Não têm componentes altamente poluentes, tais como o mercúrio sendo totalmente ecológico.



5
YEAR
WARRANTY

80.000H

CRI
>80

90°X110°

PF
>0,9



0-10V



IP66

4KV

IK08

140LM/W



SMD

1 PCS



SKU	Family	mm			kg	Cable	Power	C.Temp	Lumens	Input	€*
-----	--------	----	--	--	----	-------	-------	--------	--------	-------	----

A B C

*Ecoraee incluida | included | incluida
* IVA no incluido | VAT not included | IVA não incluído

F4722	FT-4720	685	153	136	5	8M CABLE	200W	5.000K	28.000	100-277V 50/60HZ	206,74 €
F4723	FT-4724					7M CABLE RZ1-K(AS)	240W		33.600		263,48 €

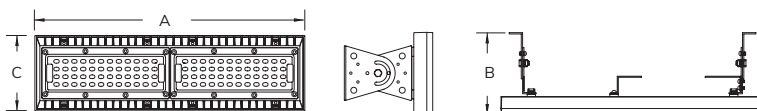



Conector F2054 incluido solo en modelo F4723
 Connector F2054 included only in model F4723
 Conector F2054 incluído apenas no modelo F4723

Fotometría | Photometry | Fotometria

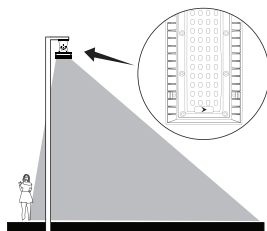

90°x110°

Lente asimétrica

Lente de ángulo apertura
 Beam angle lens
 Lente de ângulo de abertura

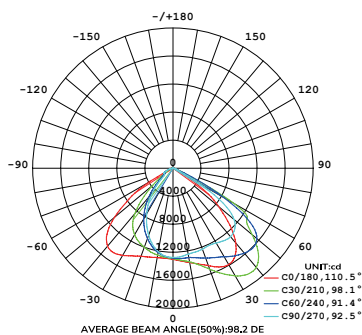

Accesorios | Accessories | Acessórios

*Ecoraee incluida | included | incluída
 * IVA no incluido | VAT not included | IVA não incluído



FT-6000/F6032

28,32 €*

 Conversor DALI - PWM
 DALI converter - PWM
 Conversor DALI - PWM



FT-2000/F2054

Conector conexión rápida
 Quick connect connector
 Conector de ligação rápida

IP68

3,21 €*

 T conexión rápida
 T quick connection
 Ligação rápida T



FT-2000/F2055

7,60 €*

 T conexión rápida
 T quick connection
 Ligação rápida T

PROYECTOR LED SMD BLACK

Es el sustituto perfecto para los focos halógenos de exterior. Se puede inclinar para dirigir la luz en función de las necesidades del momento. La luz que emite es de alta calidad como indica su CRI. El ángulo de apertura resulta muy adecuado como elemento de iluminación general.

The perfect substitute for outdoor halogen spotlights. It can be tilted to direct the light according to the needs of the moment. The light it emits is of high quality as its CRI indicates. The opening angle is very suitable as a general lighting element.

É o substituto perfeito para holofotes de halogênio ao ar livre. Pode ser inclinado para direcionar a luz, dependendo das necessidades do momento. A luz que emite é alta qualidade como indicado pelo seu CRI. Os resultados do ângulo de abertura muito adequado como elemento de iluminação geral.

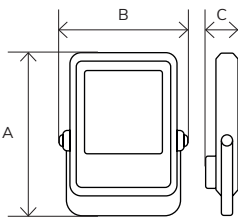

3
YEAR
WARRANTY

30.000H

CRI
>80

110°

PF
0,95

IP65

SMD

100LM/W



Con selector de cambio de temp. de color
With colour temp. change selector
Com interruptor de seleção de temp cor



SKU	Family	mm		Power	C.Temp	Lumens	LM/W	Input	Units p/	€*
		A	B	C						
F2160	FT-21015	170	133	15W	CCT 3.000K 4.000K 5.700K	1.500	100	220- 240V, 50/60Hz	10	7,99 €
F2161	FT-21030	194	133	30W		3.000			10	11,85 €
F2162	FT-21050	220	165	50W		5.000			8	13,94 €
F2163	FT-21100	293	214	100W		10.000			8	24,33 €
F2164	FT-21150	327	238	150W		15.000			6	36,91 €
F2165	FT-21200	363	270	200W		20.000			6	48,22 €

**Ecoraee incluida | included | incluída

* IVA no incluido | VAT not included | IVA não incluído

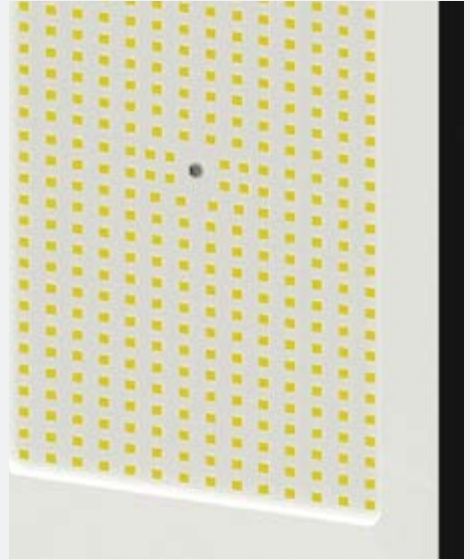

PROYECTOR LED SMD PIR SENSOR BLACK



3
YEAR
WARRANTY

30.000H

CRI
>80

110°

PF
0,95

IP65

SMD

100LM/W



Con selector de cambio de temp. de color
With colour temp. change selector
Com interruptor de seleção de temp cor



Sku	Family	mm			Power	C.Temp	Lu-	LM/W	Input	Units p/pack	€*
		A	B	C							
F2172	FT-21050	220	165	33	50W	CCT 3.000K 4.000K 5.700K	5.000	100	220- 240V, 50/60Hz	6	21,74 €

**Ecoraee incluida | included | incluída
* IVA no incluido | VAT not included | IVA não incluído

PROYECTOR LED SMD WHITE

Es el sustituto perfecto para los focos halógenos de exterior. Se puede inclinar para dirigir la luz en función de las necesidades del momento. La luz que emite es de alta calidad como indica su CRI. El ángulo de apertura resulta muy adecuado como elemento de iluminación general.

The perfect substitute for outdoor halogen spotlights. It can be tilted to direct the light according to the needs of the moment. The light it emits is of high quality as its CRI indicates. The opening angle is very suitable as a general lighting element.

É o substituto perfeito para holofotes de halogênio ao ar livre. Pode ser inclinado para direcionar a luz, dependendo da necessidades do momento. A luz que emite é alta qualidade como indicado pelo seu CRI. Os resultados do ângulo de abertura muito adequado como elemento de iluminação geral.



3
YEAR
WARRANTY

30.000H

CRI
>80

110°

PF
0,95

IP65

SMD

100LM/W



Sku	Family	mm		Power	C.Temp	Lumens	LM/W	Input	Units p/pack	€*
		A	B	C						
F2166	FT-21015	170	133	15W	CCT 3.000K 4.000K 5.700K	1.500	100	220- 240V, 50/60Hz	10	7,99 €
F2167	FT-21030	194	133	30W		3.000			10	11,85 €
F2168	FT-21050	220	165	50W		5.000			8	13,94 €
F2169	FT-21100	293	214	100W		10.000			8	24,33 €
F2170	FT-21150	327	238	150W		15.000			6	36,91 €
F2171	FT-21200	363	270	200W		20.000			6	48,22 €

**Ecorae incluida | included | incluída

* IVA no incluido | VAT not included | IVA não incluído

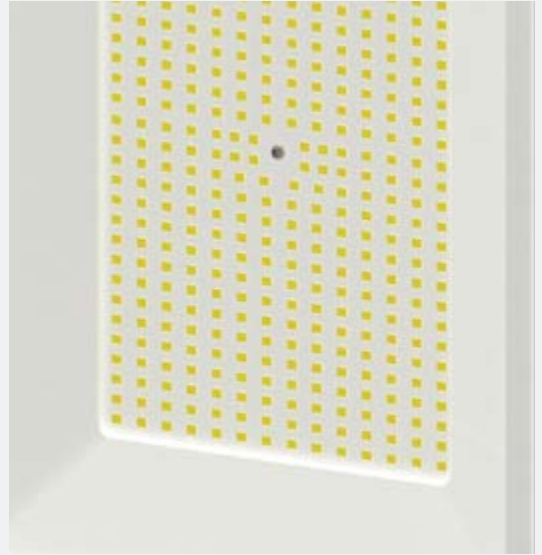

Con selector de cambio de temp. de color
With colour temp. change selector
Com interruptor de seleção de temp cor

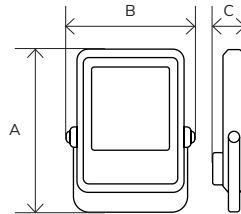

LED FLOODLIGHTS

Es el sustituto perfecto para los focos halógenos de exterior. Se puede inclinar para dirigir la luz en función de las necesidades del momento. La luz que emite es de alta calidad como indica su CRI. El ángulo de apertura resulta muy adecuado como elemento de iluminación general.

The perfect substitute for outdoor halogen spotlights. It can be tilted to direct the light according to the needs of the moment. The light it emits is of high quality as its CRI indicates. The opening angle is very suitable as a general lighting element.

É o substituto perfeito para holofotes de halogênio ao ar livre. Pode ser inclinado para direcionar a luz, dependendo da necessidades do momento. A luz que emite é alta qualidade como indicado pelo seu CRI. Os resultados do ângulo de abertura muito adequado como elemento de iluminação geral.

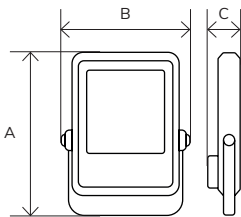

5
YEAR
WARRANTY

50.000H

CRI
>80

110°



IP65

PF
0,95

IK07

SMD

1m.
CABLE

Intertek
5029640
Only F2144*



Sku	Family	mm	kg	Power	C.Temp	Lumens	LM/W	Input	SP	Units p/pack	€*
-----	--------	----	----	-------	--------	--------	------	-------	----	--------------	----

A B C

*Ecorae incluida | included | incluída

* IVA no incluido | VAT not included | IVA não incluído

F2125	FT-21015	176	136	36	0,6	15W	3.000K	1.950	130	110-240V, 50/60Hz	2KV	12	14,41 €
F2126						4.000K							
F2127						5.700K							
F2128	FT-21030	176	136	36	0,6	30W	3.000K	3.900	130	110-240V, 50/60Hz	2KV	12	16,84 €
F2129						4.000K							
F2130						5.700K							





Sku	Family	mm			kg	Power	C.Temp	Lumens	LM/W	Input	SP	Units p/pack	€*
		A	B	C									
F2131	FT-21050	221,5	149	40	0,9	50W	3.000K	6.500				12	24,97 €
F2132							4.000K						
F2133							5.700K						
F2134	FT-21100	264,5	208	40	1,5	100W	3.000K	13.000				10	40,52 €
F2135							4.000K						
F2136							5.700K						
F2137	FT-21150	330	260	44	2,8	150W	3.000K	19.500	130	110-240V, 50/60Hz	4KV	4	78,44 €
F2138							4.000K						
F2139							5.700K						
F2140	FT-21200	365	285	48	3,2	200W	3.000K	26.000				4	99,10 €
F2143							4.000K						
F2144*							5.700K						
F2145	FT-21250	425	315	50	4,1	250W	3.000K	32.500				4	133,15 €
F2146							4.000K						
F2147							5.700K						

**Ecorae incluida | included | incluída
* IVA no incluido | VAT not included | IVA não incluído

LED FLOODLIGHTS

Fotometrías | Photometries | Fotometrias

50W

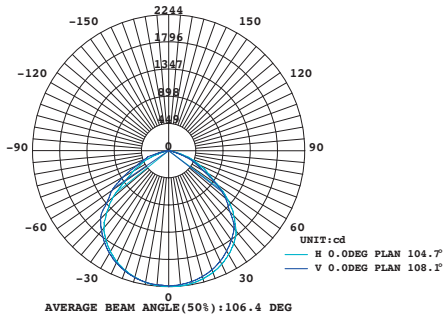

100W

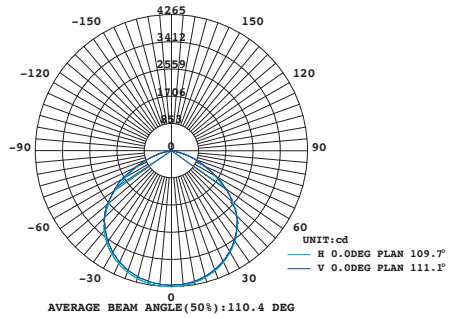

150W

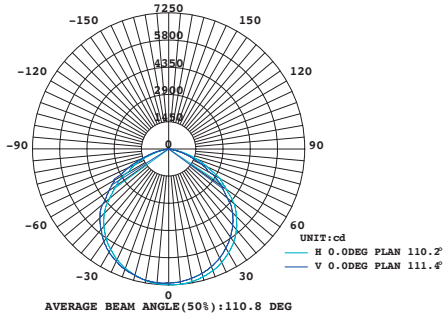

200W

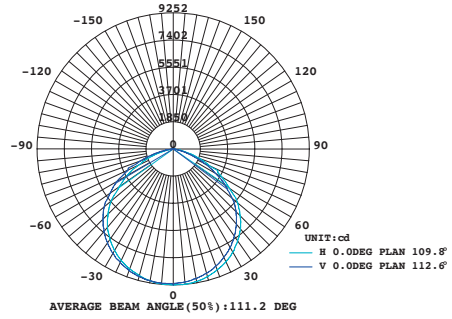

250W

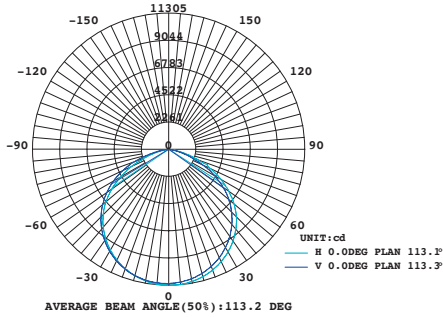

110° | Ángulo apertura
 Beam angle
 Ângulo de abertura

Accesorios | Accessories | Acessórios

*Ecoraee incluida | included | incluída
 * IVA no incluido | VAT not included | IVA não incluído



FT-2000/F2000

24,71 €*

Trípode para dos proyectores
 Tripod for two projectors
 Tripé para dois projetores



FT-2000/F2054

3,21 €*

Conector conexión rápida
 Quick connect connector
 Conector de ligação rápida

IP68



FT-2000/F2055

7,60 €*

T conexión rápida
 T quick connection
 Ligação rápida T



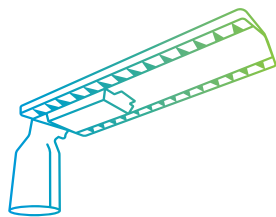

Farolas
Streetlights
Viárias



LED PRO STREETLIGHT

Remplazo perfecto para luces viales, con lentes de cristal ópticamente optimizados y cavidades ópticas selladas IP66. Uniformidad en la luz, máxima eficiencia y reduce las emisiones de CO2. Las Farolas LED PRO están fabricadas según los estándares de calidad más exigentes, presentan una gran resistencia a las condiciones meteorológicas extremas y ofrecen una garantía de 5 años.

Perfect replacement for road lights, with optically optimized glass lenses and IP66 sealed optical cavities. Uniformity in light, maximum efficiency and reduces CO2 emissions. The PRO LED Streetlights are manufactured according to the most demanding quality standards, have a great resistance to extreme weather conditions and offer a 5 year warranty.

Substituição perfeita para iluminação pública, com lentes de vidro ópticamente optimizadas e cavidades ópticas seladas IP66. Uniformidade de luz, máxima eficiência e redução de emissões de CO2. Os postes de iluminação LED PRO são fabricados de acordo com os mais exigentes padrões de qualidade, tendo grande resistência às condições meteorológicas extremas e oferecem uma garantia de 5 anos.



5
YEAR
WARRANTY

50.000H

CRI
>80

TYPE II

PF
0,9

ZHAGA

Compatible

Only F3343



IP66



6KV



IK08



140LM/W



SMD



SKU	Model	mm			kg	Power	C.Temp	Lumens	Input	€*
		A	B	C						
F3341	FT-3330	117	424	Ø66	1,1	30W	4.000K	4.200	220-240V, 50/60Hz	60,68 €
F3342	FT-3360	155	494		1,5	60W		8.400		88,45 €
F3343	FT-33100	200	623		2,4	100W		14.000		143,81 €

*Ecorae incluida | included | incluída

* IVA no incluido | VAT not included | IVA não incluído

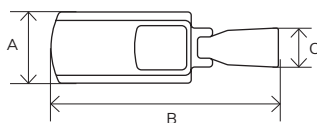

Fotometría | Photometry | Fotometria

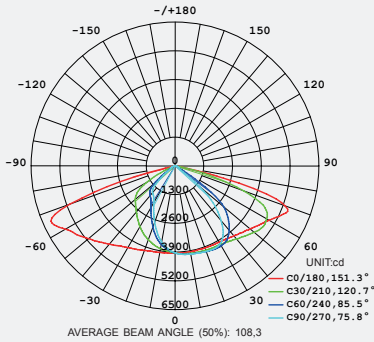

TYPE II | Ángulo apertura
Beam angle
Ângulo de abertura



Accesorios | Accessories | Acessórios

*Ecoraee incluida | included | incluída
* IVA no incluido | VAT not included | IVA não incluído



FT-2000/F2054

3,21 €*
IP68

Conector conexión rápida
Quick connect connector
Conector de ligação rápida



FT-3000/F3351

16,80 €*
STEPDIM Regulation stages base ZHAGA
Etapas de regulação STEPDIM base ZHAGA

STEPDIM Regulação etapas base ZHAGA
STEPDIM Regulation stages base ZHAGA
Etapas de regulação STEPDIM base ZHAGA



FT-3000/F3352

261,23 €*
Mando programador STEPDIM
STEPDIM programming command
Comando de programação STEPDIM

Mando programador STEPDIM
STEPDIM programming command
Comando de programação STEPDIM

STREETLIGHT HEAD ECA

Luminaria ECA LED PRO de alumbrado público y vial, de encendido instantáneo y gran potencia. Perfecto para sustituir las antiguas farolas de descarga, mejorando la calidad de la luz y reduciendo notablemente su consumo energético. Tiene una bisagra interior que mejora su estética y una óptica multiLED protegida con cristal templado.

ECA LED PRO luminaire for public lighting and road, instant on and great power. Perfect to replace old discharge lamps, improving the quality of light and significantly reducing energy consumption. It has an interior hinge that improves its aesthetic and a multiLED optic protected with tempered glass.

Luminária ECA LED PRO para iluminação pública, ignição instantânea e grande potência. Ideal para substituição de lâmpadas de descarga antigas, melhorando a qualidade da luz e reduzindo significativamente o consumo energético tem uma dobradiça interior que dá-lhe mais estética e uma ótica multiled protegida com vidro temperado.



SKU	Module	mm			kg	Power	C.Temp	Lumens	Input	€*
		A	B	C						
F51441	Luminaria Eca + Módulo Luminaire Eca + Module Luminária Eca + Módulo	F3344					3.000K	6.500	100-240V, 50/60Hz	227,46 €
F51442		F3345	180	Ø485	Ø60	3,4	50W			4.000K
F51443		F3305						4.000K	5.500	191,08 €

Detalles módulos LED en páginas 50, 51 y 52

Accesorios luminarias ECA | ECA luminaire accessories | Acessórios para luminárias ECA

*Ecorae incluida | included | incluída
* IVA no incluido | VAT not included | IVA não incluído



FT-3000/F3015

14,05 €*

Protector sobre tensión Philips SP1
Philips voltage protector SP1
Protetor contra sobretensões Philips SP1



FT-2000/F2054

3,21 *

Conector conexión rápida
Quick connect connector
Conector de ligação rápida

IP68

STREETLIGHT HEAD INVERTED ECA

Cuerpo para luminaria INVERTED ECA LED PRO de alumbrado público y vial, de encendido instantáneo y gran potencia. Perfecto para sustituir las antiguas farolas de descarga, mejorando la calidad de la luz y reduciendo notablemente su consumo energético. Tiene una bisagra interior que mejora su estética y una óptica multiLED protegida con cristal templado.

INVERTED ECA LED PRO luminaire for public lighting and road, instant on and great power. Perfect to replace old discharge lamps, improving the quality of light and significantly reducing energy consumption. It has an interior hinge that improves its aesthetic and a multiLED optic protected with tempered glass.

Luminária INVERTED ECA LED PRO para iluminação pública, ignição instantânea e grande potência. Ideal para substituição de lâmpadas de descarga antigas, melhorando a qualidade da luz e reduzindo significativamente o consumo energético tem uma dobradiça interior que dá-lhe mais estética e uma ótica multiled protegida com vidro temperado.

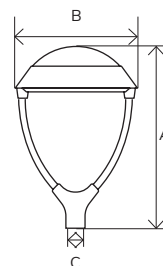

Producto desmontado necesita ensamble
Disassembled product needs assembly
Produto desmontado necessita de montagem



SKU	Module	mm			kg	Power	C.Temp	Lumens	Input	€*
		A	B	C						
F52441	F3344						3.000K	6.500	100-240V, 50/60Hz	279,22 €
F52442	F3345	681	Ø485	Ø60	4,3	50W	4.000K			279,22 €
F52443	F3305						4.000K	5.500		242,33 €

Detalles módulos LED en páginas 50, 51 y 52

Componentes luminarias ECA | ECA luminaire components | Componentes de luminárias ECA



FT-5140/F5144 149,91 €*

Cuerpo Luminaria ECA
ECA luminaire body
Corpo da luminária ECA



FT-5240/F5244 201,30 €*

Cuerpo luminaria INVERTED ECA
INVERTED ECA luminaire body
Corpo da luminária ECA INVERTIDO

*Ecorae incluida | included | incluída
* IVA no incluido | VAT not included | IVA não incluído

VILLA STREETLIGHT

La Luminaria Villa LED está fabricada en acero y presenta un diseño clásico y elegante, con un acabado en color negro. Es resistente a los rayos ultravioleta UV. Su fijación va directa a la columna o a un brazo mural con terminación en racor de 3/4".

The Villa LED luminaire is made of steel and features a classic and elegant design with a black finish. Resistant to ultraviolet UV rays. The fitting goes directly to the column or to a wall arm with a 3/4" fitting.

A luminária LED Villa é feita de aço e tem um design clássico e elegante, com um acabamento preto. É resistente aos raios ultravioleta UV. Sua fixação vai diretamente para a coluna ou para um braço de parede com um acabamento de 3/4".



Producto desmontado necesita ensamblaje. Acero.
Disassembled product needs assembly. Steel.
Produto desmontado necessita de montagem. Aço.



SKU	Module	mm			kg	Power	C.Temp	Lumens	Input	€*
		A	B	C						
F30121	Luminaria Villa + Módulo Luminaire Villa + Module Luminária Villa + Módulo	F3344				50W	3.000K	6.500	100-240V, 50/60Hz	203,24 €
F30122		F3345	780	395	60		6			4.000K
F30123		F3305						4.000K		5.500

Detalles módulos LED en páginas 50, 51 y 52

Accesorios | Accessories | Acessórios

*Ecoraee incluída | included | incluída
 * IVA no incluido | VAT not included | IVA não incluído



FT-3000/F3018 **36,30 €***

Adaptador Farol Villa Punta 60mm
 Lantern Adapter Villa Punta 60mm
 Adaptador de lanterna Villa Punta 60mm



FT-3000/F3014 **131,60 €***

Brazo pared farola Villa
 Villa streetlight wall arm
 Braço poste de luz Villa

600mm



FT-3000/F3015 **14,05 €***

Protector sobre tensión Philips SP1
 Philips voltage protector SP1
 Protetor contra sobretensões Philips SP1

Componentes | Components | Componentes

*Ecoraee incluída | included | incluída
 * IVA no incluido | VAT not included | IVA não incluído



FT-3000/F3012 **115,50 €***

Cabezar Farol Villa
 Villa Streetlight head
 Cabeça de luminária Villa led



FT-3000/F3013 **10,29 €***

Adaptador módulo LED
 LED module adapter
 Adaptador de módulo LED

LED PRO STREETLIGHT BULB

Bombilla de radiación IR no UV. Encendido instantáneo del 100%. Baja salida térmica. Perfecta para sustituir lámparas incandescentes convencionales en áreas comerciales, zonas urbanas y con una larga vida útil. Solo apto para funcionamiento vertical.

Non-UV IR radiation bulb. Instant ignition of 100%. Low thermal output. Perfect to replace conventional incandescent lamps in commercial areas, urban areas and with a long service life. Suitable for vertical operation only.

Lâmpada sem radiação ir e UV. Ignição instantânea 100%. Baixa emissão térmica. Ideal para substituir lâmpadas incandescentes convencionais em locais comerciais, espaços urbanos e com uma longa vida útil.



5
YEAR
WARRANTY

50.000H

330°

E27

SP
4KV

19W

33W

47W



Ø75x175 mm

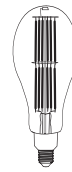

Ø90x240 mm

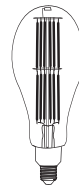

Ø100x262 mm



Skü	Family	Power	C.Temp	LM/W	Lumens	Input	€*
-----	--------	-------	--------	------	--------	-------	----

Ecorae incluida | included | incluída
* IVA no incluido | VAT not included | IVA não incluído

F3417				2.700K			
F3418	FT-3419	19W	ED75	4.000K	212	4.000	18,35 €
F3419				6.000K			
F3420				2.700K			
F3421	FT-3433	33W	ED90	4.000K	212	7.000	31,17 €
F3422				6.000K			
F3423				2.700K			
F3424	FT-3447	47W	ED100	4.000K	212	10.000	44,67 €
F3425				6.000K			
F3425				6.000K			

LED STREETLIGHT BULB

Bombilla de radiación IR no UV. Encendido instantáneo del 100%. Baja salida térmica. Perfecta para sustituir lámparas incandescentes convencionales en áreas comerciales, zonas urbanas y con una larga vida útil. Solo apto para funcionamiento vertical.

Non-UV IR radiation bulb. Instant ignition of 100%. Low thermal output. Perfect to replace conventional incandescent lamps in commercial areas, urban areas and with a long service life. Suitable for vertical operation only.

Lâmpada sem radiação ir e UV. Ignição instantânea 100%. Baixa emissão térmica. Ideal para substituir lâmpadas incandescentes convencionais em locais comerciais, espaços urbanos e com uma longa vida útil.



Solo apto para funcionamiento vertical.
Suitable for vertical operation only.
Apenas para utilização vertical

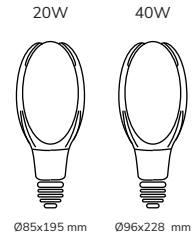

3
YEAR
WARRANTY

25.000H

CRI
>80

330°



IP20



1KV



E27

PF
>0,9



SMD



20 PCS



SKU	Family	Power	C.Temp	LM/W	Lumens	Input	€*
-----	--------	-------	--------	------	--------	-------	----

Ecoraee incluida | included | incluída
* IVA no incluido | VAT not included | IVA não incluido

F3411	FT-3420	20W	3.000K	130	2.600	220-240V, 50Hz	16,00 €
F3412			4.000K				
F3413			6.500K				
F3414	FT-3440	40W	3.000K				
F3415			4.000K				
F3416			6.500K				

Fotometría | Photometry | Fotometria

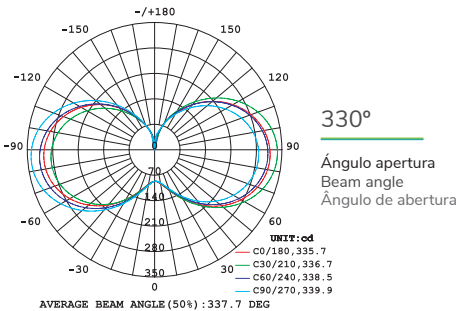

Accesorios | Accessories | Acessórios

*Ecoraee incluida | included | incluída
* IVA no incluido | VAT not included | IVA não incluido



FT-3445/F3404

0,56 €*

Adaptador conversor E40-E27
E40-E20 converter adapter
Adaptador conversor E40-E20

LED MODULE 130 L/W. Bridgelux LED

El módulo LED de Filux está fabricado según los estándares de calidad más exigentes y ofrece una garantía de 5 años. Presenta una gran resistencia a las condiciones meteorológicas extremas.

Filux's LED module is manufactured to the highest quality standards and offers a 5-year warranty. It is highly resistant to extreme weather conditions.

O módulo LED Filux é fabricado de acordo com os mais elevados padrões de qualidade oferecendo uma garantia de 5 anos. É bastante resistente a condições climáticas adversas.

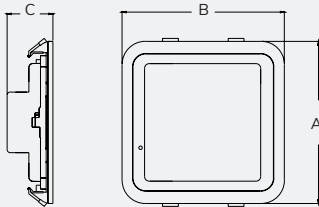

5
YEAR
WARRANTY

50.000H

CRI
>80

TYPE II

PF
>0,9

STEP DIMMING
REGULATION

IP66

SP
4KV

IK08

130LM/W



10 PCS



SKU	Family	mm			kg	Power	C.Temp	Lumens	Input	€*
		A	B	C						
F3344	FT-3350	210	59,30	1,5	50W	3.000K	6.500	100-240V, 50/60Hz	77,74 €	
F3345						4.000K				

*Ecorae incluida | included | incluida
* IVA no incluido | VAT not included | IVA não incluido

Fotometría | Photometry | Fotometria

TYPE II | Ángulo apertura
Beam angle
Ângulo de abertura

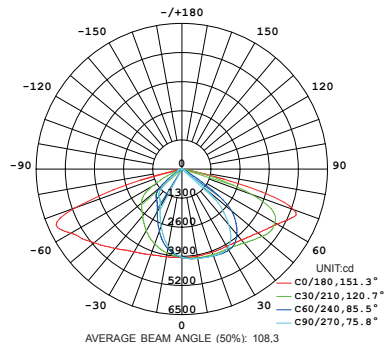



Accesorios | Accessories | Acessórios

*Ecorae incluida | included | incluída
 * IVA no incluido | VAT not included | IVA não incluído



FT-3000/F3015 14,05 €*

Protector sobre tensión Philips SP1
 Philips voltage protector SP1
 Protetor contra sobretensões Philips SP1



FT-2000/F2054 3,21 €*

Conector conexión rápida
 Quick connect connector
 Conector de ligação rápida

IP68



FT-2000/F2055 7,60 €*

T conexión rápida
 T quick connection
 Ligação rápida T

LED MODULE 110 L/W

Los módulos LED Filux están fabricados según los estándares de calidad más exigentes y ofrecen una garantía de 3 años. Presentan una gran resistencia a las condiciones meteorológicas extremas.

Filux LED modules are manufactured to the highest quality standards and offer a 3 year warranty. They are highly resistant to extreme weather conditions.

Os módulos LED Filux são fabricados com os elevados padrões de qualidade oferecendo uma garantia de 3 anos. Têm grande resistência às condições climáticas extremas.

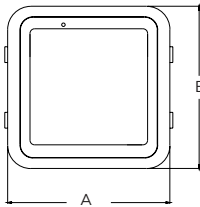
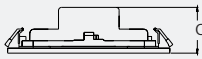

3
YEAR
WARRANTY

50.000H

CRI
>80

TYPE II

PF
>0,9

IP66

4KV

IK08

110LM/W

10 PCS

SMD



SKU	Family	mm			kg	Power	C.Temp	Lumens	Input	€*
		A	B	C						
F3305	FT-3350	210	59,30	1,5	50W	4.000K	5.500	100-240V, 50/60Hz	41,18 €	

*Ecoraee incluída | included | incluída
* IVA no incluído | VAT not included | IVA não incluído

Fotometría | Photometry | Fotometria

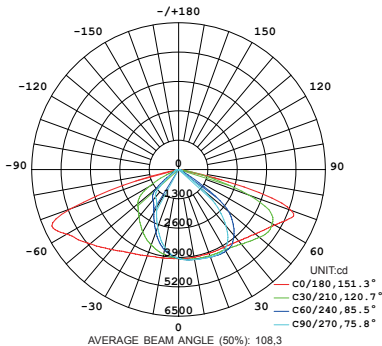

TYPE II | Ángulo apertura
Beam angle
Ângulo de abertura

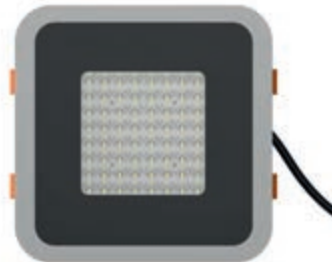



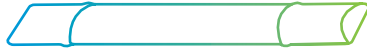

Luminarias estancas
Waterproof luminaires
Luminárias estanques



LUMINARIAS ESTANCAS | WATERPROOF LUMINAIRES | LUMINÁRIAS ESTANQUES

WATERPROOF FITTING LED PRO

La aplicación de las pantallas Estanca LED de Filux se extiende a cualquier espacio amplio, tanto interior como exterior y la instalación se realiza sin tener que modificar el cableado. Están fabricadas en materiales polímeros que aseguran su perdurabilidad en el tiempo.

The application of Filux LED Waterproof screens extends to any large space, both indoors and outdoors, and the installation is carried out without having to modify the wiring. They are made of polymer materials that ensure their durability over time.

A aplicação das telas Filux LED Waterproof estende-se a qualquer grande espaço, tanto interior como exterior, e a instalação é realizada sem necessidade de modificar a cablagem. São feitos de materiais poliméricos que garantem sua durabilidade ao longo do tempo.



Clips inox. 304.

5
YEAR
WARRANTY

50.000H

CRI
>80

120°

PF
>0,9



Con selector de cambio de temp. de color
With colour temp. change selector
Com interruptor de seleção de temp cor

130LM/W

IP65

IK08

6 PCS

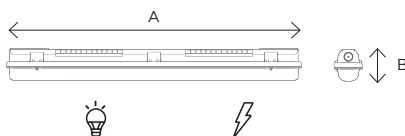

Model	SKU	mm	Power	Colour selector	Lumens	Input	€*
		A	B	*Ecoraee incluida included incluída * IVA no incluido VAT not included IVA não			
FT-1120	F1160	685	20W	3.000K 4.000K 5.000K	2.600	220-240V, 50-60Hz	25,02 €
FT-1140	F1161	1295	40W	3.000K 4.000K 5.000K	5.200		34,94 €
FT-1150	F1162	1595	60W	3.000K 4.000K 5.000K	7.800		44,33 €

Accesorios | Accessories | Acessórios

*Ecoraee incluida | included | incluída
* IVA no incluido | VAT not included | IVA não incluído



FT-1100	F1163	Sensor de movimiento para F1161/F1162	12,75 €*
FT-7000	F7029	EMERGENCY KIT AC OUT 8-36W	104,90 €*
	F7030	EMERGENCY KIT AC OUT 30-50W	195,92 €*

LED WATERPROOF FITTING

La aplicación de las pantallas Estanca LED de Filux se extiende a cualquier espacio amplio, tanto interior como exterior y la instalación se realiza sin tener que modificar el cableado. Están fabricadas en materiales polímeros que aseguran su perdurabilidad en el tiempo.

The application of Filux LED Waterproof screens extends to any large space, both indoors and outdoors, and the installation is carried out without having to modify the wiring. They are made of polymer materials that ensure their durability over time.

A aplicação das telas Filux LED Waterproof estende-se a qualquer grande espaço, tanto interior como exterior, e a instalação é realizada sem necessidade de modificar a cablagem. São feitos de materiais poliméricos que garantem sua durabilidade ao longo do tempo.

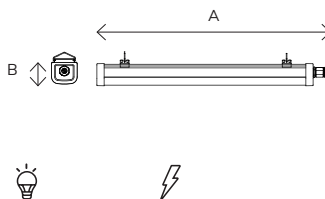
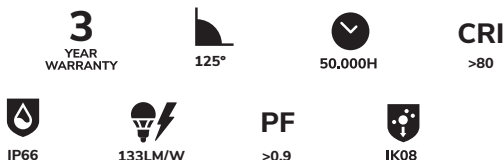

Model	SKU	mm		Power	Colour selector	Lumens	Input	€*
		A	B					
FT-1120	F1120	595	65,2	15W	5.000K	2.000	220-240V, 50-60Hz	13,77 €
FT-1140	F1121	1185		30W		4.000		21,73 €
FT-1150	F1122	1485		46,5W		6.000		26,87 €

Accesorios | Accessories | Acessórios

*Ecoraee incluida | included | incluída
*IVA no incluido | VAT not included | IVA não incluído



FT-7000	F7029	EMERGENCY KIT AC OUT 8-36W	104,90 €*
	F7030	EMERGENCY KIT AC OUT 30-50W	195,92 €*

WATERPROOF FITTINGS

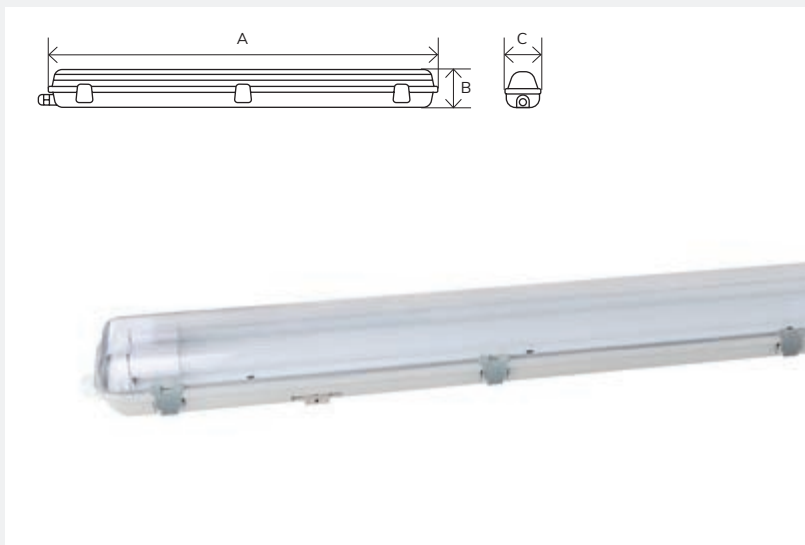

IK08

Sku	Family	mm			Descripción Description Descrição	€*	
		A	B	C			
F5101	FT-5106	661	70	70	Pantalla Estanca IP65 600 mm para 1 tubo Waterproof Fitting IP65 600 mm for 1 tube Armadura Estanque IP65 de 600 mm para 1 tubo	9,37 €	
F5102	FT-5112	1271			Pantalla Estanca IP65 1.200 mm para 1 tubo Waterproof Fitting IP65 1.200 mm for 1 tube Armadura Estanque IP65 de 1.200 mm para 1 tubo	12,27 €	
F5103	FT-5115	1571			Pantalla Estanca IP65 1.500 mm para 1 tubo Waterproof Fitting IP65 1.500 mm for 1 tube Armadura Estanque IP65 de 1.500 mm para 1 tubo	17,16 €	
F5201	FT-5206	661		95	95	Pantalla Estanca IP65 600 mm para 2 tubos Waterproof Fitting IP65 600 mm for 2 tubes Armadura Estanque IP65 de 600 mm para 2 tubos	11,07 €
F5202	FT-5212	1271				Pantalla Estanca IP65 1.200 mm para 2 tubos Waterproof Fitting IP65 1.200 mm for 2 tubes Armadura Estanque IP65 de 1.200 mm para 2 tubos	14,15 €
F5203	FT-5215	1571				Pantalla Estanca IP65 1.500 mm para 2 tubos Waterproof Fitting IP65 1.500 mm for 2 tubes Armadura Estanque IP65 de 1.500 mm para 2 tubos	19,91 €

*Ecoraee incluída | included | incluída

* IVA no incluído | VAT not included | IVA não incluído

KIT GRAPAS



Clips inox. 304.

SKU	Family	To	Descripción Description Descrição	€*
*Ecorae incluida included incluída * IVA no incluido VAT not included IVA não incluído				
F5205	FT-5000	60CM	Kit grapas inox 304 para pantalla 60CM 304 stainless steel staple kit for 60CM screen Kit de grampos de aço inoxidável 304 para tela de 60 CM	1,26 €
F5206		120CM	PKit grapas inox 304 para pantalla 120CM 304 stainless steel staple kit for 120CM screen Kit de grampos de aço inoxidável 304 para tela de 120 CM	1,95 €
F5207		150CM	Kit grapas inox 304 para pantalla 150CM 304 stainless steel staple kit for 150CM screen Kit de grampos de aço inoxidável 304 para tela de 150 CM	2,31 €

Accesorios | Accessories | Acessórios

*Ecorae incluida | included | incluída
* IVA no incluido | VAT not included | IVA não incluído



FT-7000	F7028	EMERGENCY KIT AC OUT 10W	80,60 €* 80,60 €*
	F7029	EMERGENCY KIT AC OUT 8-36W	104,90 €* 104,90 €*
	F7030	EMERGENCY KIT AC OUT 30-50W	195,92 €* 195,92 €*



Tubos

Tubes

Tubos



FILUX

T8 LED TUBE PRO

Las lámparas de tubo T8 LED de Filux son de vidrio con cubierta de plástico anti rotura. Disponemos de diferentes modelos con distintas temperaturas de color, entre los que destacamos el blanco neutro, el blanco frío o el blanco cálido. Estas lámparas de tubo LED cuentan con un sistema de encendido instantáneo y aguantan temperaturas de (-20° a 45°).

Filux T8 LED tubes are made of glass with an anti-breakage plastic cover. We have different models with different color temperatures, among them we highlight the ones with neutral white, cold white or warm white. These LED tube lamps feature an instantaneous ignition system and withstand temperatures of (-20° to 45°).

Os tubos LED Filux T8 são feitos de vidro com uma tampa de plástico anti-quebra. Temos diferentes modelos com diferentes temperaturas de cor, entre os quais o branco neutro, o branco frio ou o branco quente. Estas lâmpadas de tubo LED têm um sistema de ignição e retenção instantâneas (-20° a 45°).



5
YEAR
WARRANTY

50.000H

CRI
>80

300°

PF
>0,9



IP20



130LM/W



G13



10PCS



SMD



24H
POWER

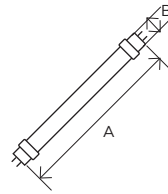

Con selector de cambio de temp. de color
With color temperature charge selector
Com interruptor de seleção de temp. de cor



Model	Sku	mm	g	Power	Colour selector	Lumens	Input	€*	
FT-1009	F1040	600	Ø 28	100,9	9W	3.000K 4.000K 6.500K	1.170	220-240V, 50-60Hz	5,89 €
FT-1014	F1041	900		147,6	16W	3.000K 4.000K 6.500K	2.080		7,00 €
FT-1018	F1042	1200		191,1	18W	3.000K 4.000K 6.500K	2.340		7,68 €
FT-1022	F1043	1500		234,5	24W	3.000K 4.000K 6.500K	3.120		9,54 €

Accesorios | Accessories | Acessórios

*Ecoraee incluida | included | incluída
* IVA no incluido | VAT not included | IVA não incluído



FT-1000	F1013	Sustituto cebador	0,21 €*
---------	-------	-------------------	---------

T8 LED TUBE VALUE

Las lámparas de tubo T8 LED de Filux son de vidrio con cubierta de plástico anti rotura. Disponemos de diferentes modelos con distintas temperaturas de color, entre los que destacamos el blanco neutro, el blanco frío o el blanco cálido. Estas lámparas de tubo LED cuentan con un sistema de encendido instantáneo y aguantan temperaturas de (-20° a 45°).

Filux T8 LED tubes are made of glass with an anti-breakage plastic cover. We have different models with different color temperatures, among them we highlight the ones with neutral white, cold white or warm white. These LED tube lamps feature an instantaneous ignition system and withstand temperatures of (-20° to 45°).

Os tubos LED Filux T8 são feitos de vidro com uma tampa de plástico anti-quebra. Temos diferentes modelos com diferentes temperaturas de cor, entre os quais o branco neutro, o branco frio ou o branco quente. Estas lâmpadas de tubo LED têm um sistema de ignição e retenção instantâneas (-20° a 45°).



3
YEAR
WARRANTY

30.000H

CRI
>80

300°



IP20



100LM/W



G13



SMD



10PCS

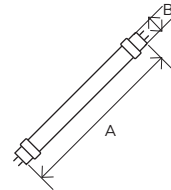

Model	SKU	mm	Power	C. Temp	Lumens	Input	€*
		A	B	*Ecoraee incluida included incluída * IVA no incluido VAT not included IVA não incluído			
FT-1009	F1050	600	9W	3.000K	900	220-240V, 50-60Hz	2,90 €
	F1051			4.000K			
	F1052			6.500K			
FT-1018	F1053	1200	18W	3.000K	1.800	220-240V, 50-60Hz	3,86 €
	F1054			4.000K			
	F1055			6.500K			
FT-1022	F1056	1500	22W	3.000K	2.200	220-240V, 50-60Hz	4,76 €
	F1057			4.000K			
	F1058			6.500K			

Accesorios | Accessories | Acessórios

*Ecoraee incluida | included | incluída

* IVA no incluido | VAT not included | IVA não incluído



FT-1000	F1013	Sustituto cebador	0,21 €*
---------	-------	-------------------	---------



Regletas
Battens
Luminárias

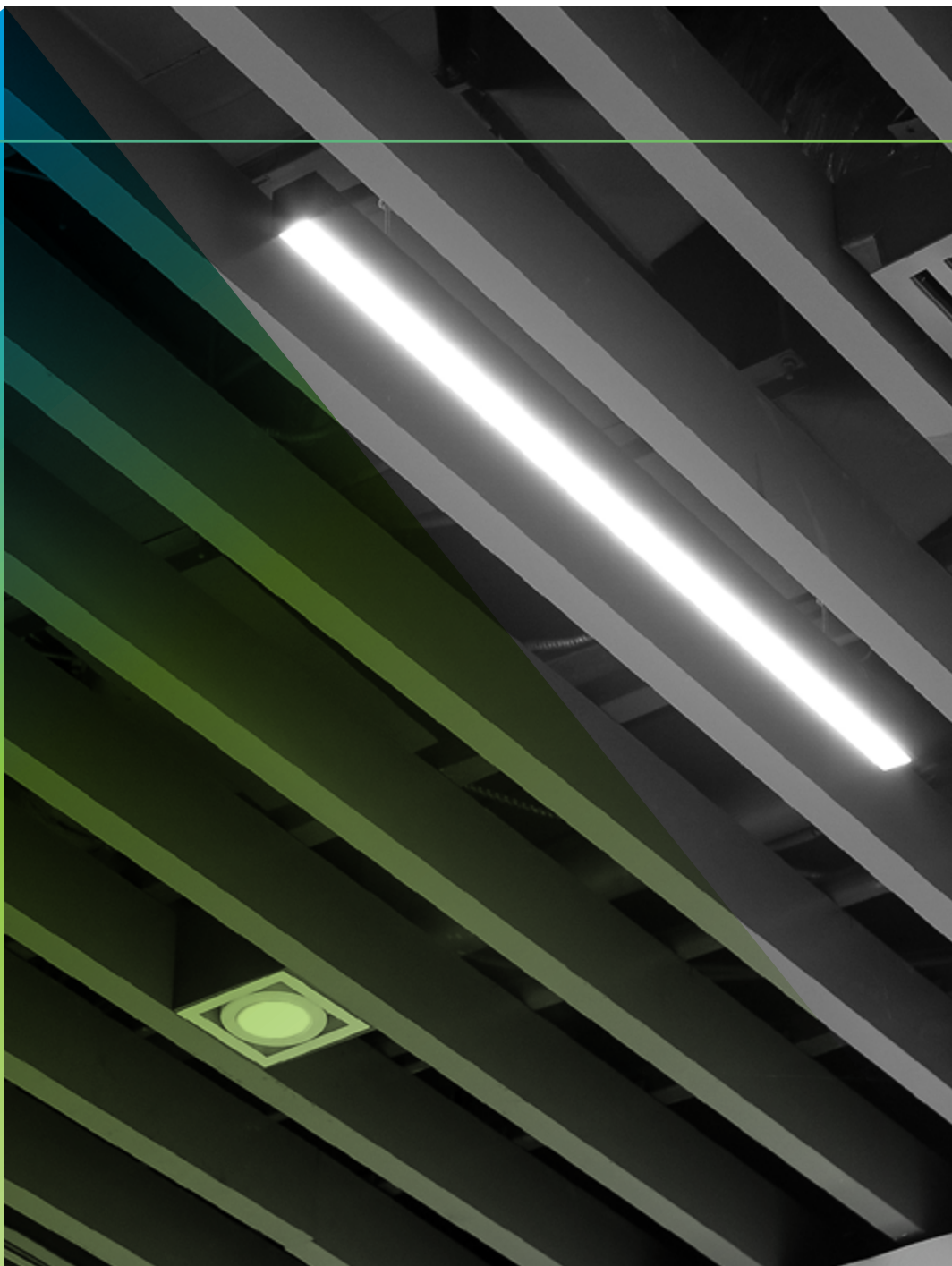

LED SUPER-SLIM IP20

Los plafones super slim LED de Filux son un sustituto perfecto para las pantallas de tubos fluorescentes tradicionales. Los plafones super Slim de Filux están hechos en aluminio + plástico y son ideales para oficinas, hoteles, concesionarios, centros comerciales, supermercados, almacenes, parkings.

The Filux LED super slim ceiling lamps are a perfect substitute for traditional fluorescent tube displays. The Filux super slim panels are made of aluminum + plastic and are ideal for offices, hotels, dealers, malls, supermarkets, warehouses, car parks.

Os painéis LED super slim da Filux são o substituto perfeito para armaduras de tubos fluorescentes tradicionais os painéis filux super slim são feito em alumínio + plástico são ideais para escritórios, hotéis, concessionários, centros comerciais, supermercados, armazéns, estacionamentos.



3
YEAR
WARRANTY

25.000H

CRI
≥80

120°



IP20



IK06



SMD



Skü	Family	mm			Power	Colour Selector	Lumens	Input	€*
		A	B	C					
F2180	FT-2120	600	70	27	20W	CCT 3.000K 4.200K 6.500K	2.400	220-240V, 50/60Hz	9,17 €
F2181	FT-2140	1.200			36W		4.800		15,00 €
F2182	FT-2150	1.500			48W		6.000		18,00 €

*Ecoraee incluida | included | incluída

* IVA no incluido | VAT not included | IVA não incluído



Con selector de cambio de temp. de color
With color temperature change selector
Com interruptor de seleção de temp. de cor

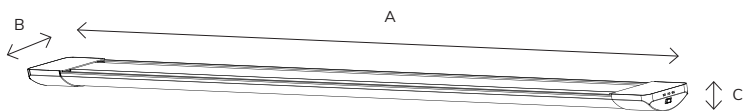

LED SUPER SLIM IP20

Los plafones super slim LED de Filux son un sustituto perfecto para las pantallas de tubos fluorescentes tradicionales. Los plafones super Slim de Filux están hechos en aluminio + plástico y son ideales para oficinas, hoteles, concesionarios, centros comerciales, supermercados, almacenes, parkings.

The Filux LED super slim ceiling lamps are a perfect substitute for traditional fluorescent tube displays. The Filux super slim panels are made of aluminum + plastic and are ideal for offices, hotels, dealers, malls, supermarkets, warehouses, car parks.

Os painéis LED super slim da Filux são o substituto perfeito para armaduras de tubos fluorescentes tradicionais os painéis filux super slim são feito em alumínio + plástico são ideais para escritórios, hotéis, concessionários, centros comerciais, supermercados, armazéns, estacionamento.

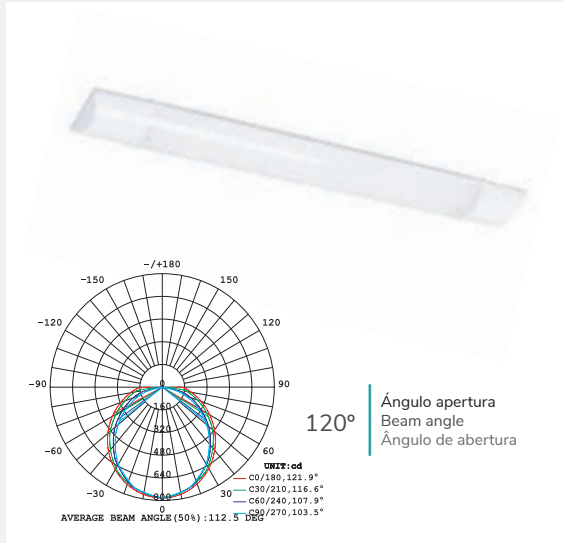

3
YEAR
WARRANTY

25.000H

CRI
>80

120°

PF
>0,9

IP20

IK06

SMD

40 PCS



Sku	Family	mm			kg	Power	C.Temp	Lumens	Input	€*
		A	B	C						
F2121	FT-2120	600	75	22	0,20	20W	4.000K	1.700-1.800	220-240V, 50Hz	8,99 €
F2122							6.000K			
F2141	FT-2140	1.200	75	22	0,28	40W	4.000K	3.500-3.600	220-240V, 50Hz	14,81 €
F2142							6.000K			
F2151	FT-2150	1.500	75	22	0,36	50W	4.000K	4.200-4.500	220-240V, 50Hz	17,71 €
F2152							6.000K			

*Ecoraee incluída | included | incluída
 * IVA no incluído | VAT not included | IVA não incluído

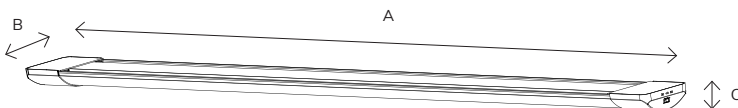

T5 BATTEN WITH SWITCH

La barra lineal T5 de Filux con interruptor incorporado puede conectarse una a una y un interruptor puede controlar hasta 10 lámparas. Diferentes modelos pueden conectar hasta 8 lámparas. La corriente máxima permitida de lámparas es 0,8A.

Filux T5 linear bar with built-in switch can be connected one by one and one switch can control up to 10 lamps. Different models can connect up to 8 lamps. The maximum allowed current of lamps is 0.8A.

A barra linear Filux T5 com interruptor embutido pode ser conectada uma a uma e uma chave pode controlar até 10 lâmpadas. Diferentes modelos podem conectar até 8 lâmpadas. A corrente máxima permitida das lâmpadas é 0,8A.



3
YEAR
WARRANTY

>15.000H

PF
0,5

110°

IP20



Model	SKU	mm			kg	Power	C.Temp	Lumens	Input	Units p/pack	€*
		A	B	C							
FT-1104	F1147	272	22	36	0,20	4W	4.000K	320	220-240V, 50/60Hz	40	5,81 €
	F1148						6500K				
FT-1108	F1149	572	22	36	0,28	8W	4.000K	640	220-240V, 50/60Hz	40	6,81 €
	F1150						6.500K				
FT-1116	F1151	1.172	22	36	0,36	16W	4.000K	1.280	220-240V, 50/60Hz	30	9,37 €
	F1152						6.500K				

*Ecorae incluida | included | incluída
* IVA no incluido | VAT not included | IVA não incluído

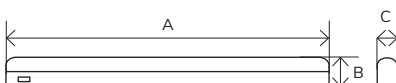

Conexión 2 laterales | 2 side connection | 2 ligações laterais
Max. potencia conectable 175W | Max. power linkable 175W | Potencia conectável max. 175W



Paneles

Panels

Painéis

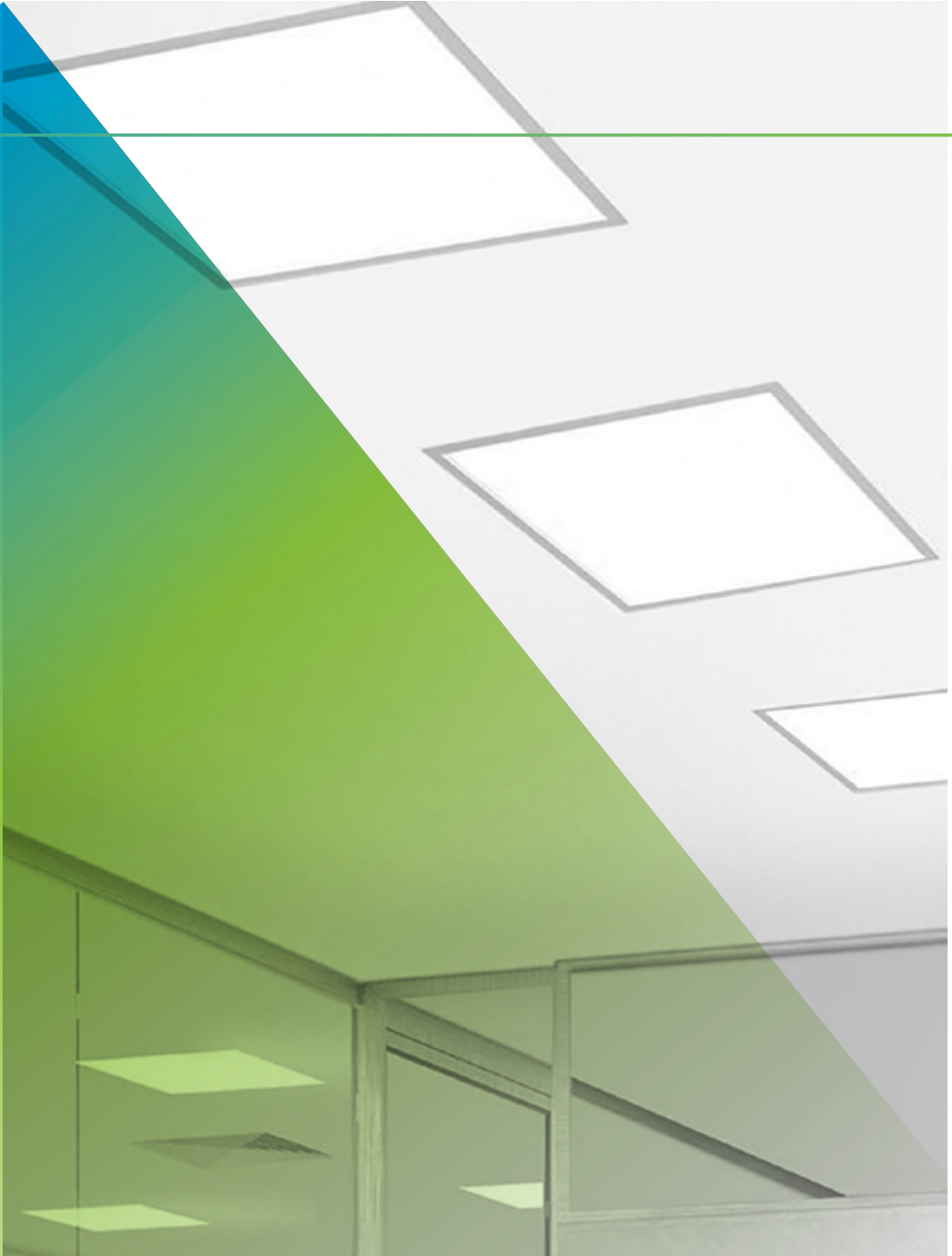

LED PANEL 60X60 PRO UGR

Los paneles UGR LED PRO, brindan una luz ideal para oficinas, tiendas, hoteles, hospitales, escuelas e institutos. Aportando un mayor confort visual con su difusor que asegura una salida luminosa homogénea, asegurando en todos los puntos el factor de deslumbramiento UGR<19.

UGR LED PRO panels provide an ideal light for offices, shops, hotels, hospitals, schools and institutes. Providing greater visual comfort with its diffuser that ensures a homogenous light output, ensuring at all points the glare factor UGR <19.

Os painéis UGR LED PRO fornecem uma luz ideal para escritórios, lojas, hotéis, hospitais, escolas e institutos. Proporcionando maior conforto visual com seu difusor que garante uma saída de luz homogênea, garantindo em todos os pontos o fator de brilho UGR <19.

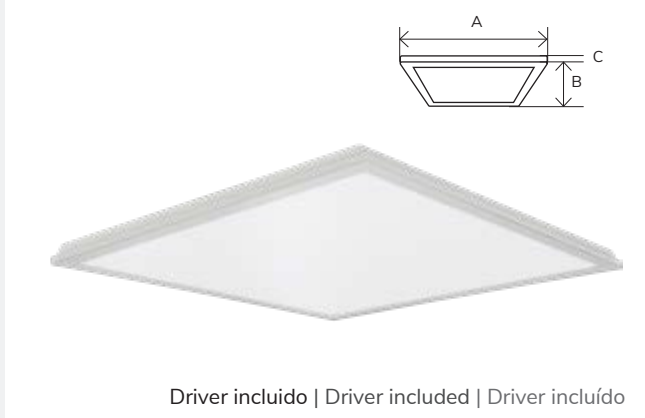

5
YEAR
WARRANTY

50.000H

CRI
>80

110°

PF
>0,9

IP40

UGR
<19

RUNLITE

5 PCS

Skü	Family	mm	kg	Power	Driver	Reg.	C.Temp	Lumens	Input	€*
		A	B	C						
F80701	FT-8600	595	595	29	1,45	Philips	No-Dim	4.000K	220-240V, 50/60Hz	28,74 €
F80711								6.500K		
F80702								4.000K		
F80712								6.500K		
F80703						Lifud	4.000K	3.600	27,22 €	
F80713										6.500K
F80704						Lifud	4.000K	4.400	46,60 €	
F80714										6.500K
F80705										0-10V
F80715										6.500K
F80706						Lifud	4.000K	4.400	39,67 €	
F80716										6.500K
F80706						Lifud	4.000K	4.400	45,05 €	
F80716										6.500K

*Ecoraee incluida | included | incluída
* IVA no incluido | VAT not included | IVA não incluído

Accesorios | Accessories | Acessórios

*Ecoraee incluida | included | incluída
* IVA no incluido | VAT not included | IVA não incluído



FT-8000/F8007

12,88 €*

Kit de superfície para panel 60x60
Surface kit for 60x60 panel
Kit de superfície para panel 60x60



FT-8000/F8009

6,71 €*

Kit de suspensión para panel 60x60
Suspension kit for 60x60 panel
Kit de suspensão para panel 60x60



FT-8000/F8030

15,72 €*

Marco para empotrar para panel 60x60
Recessed frame for 60x60 panel
Moldura de encastrar para panel 60x60

LED PANEL 120X30 PRO UGR

Los paneles UGR LED PRO, brindan una luz ideal para oficinas, tiendas, hoteles, hospitales, escuelas e institutos. Aportando un mayor confort visual con su difusor que asegura una salida luminosa homogénea, asegurando en todos los puntos el factor de deslumbramiento UGR<19.

UGR LED PRO panels provide an ideal light for offices, shops, hotels, hospitals, schools and institutes. Providing greater visual comfort with its diffuser that ensures a homogenous light output, ensuring at all points the glare factor UGR <19.

Os painéis UGR LED PRO fornecem uma luz ideal para escritórios, lojas, hotéis, hospitais, escolas e institutos. Proporcionando maior conforto visual com seu difusor que garante uma saída de luz homogênea, garantindo em todos os pontos o fator de brilho UGR <19.

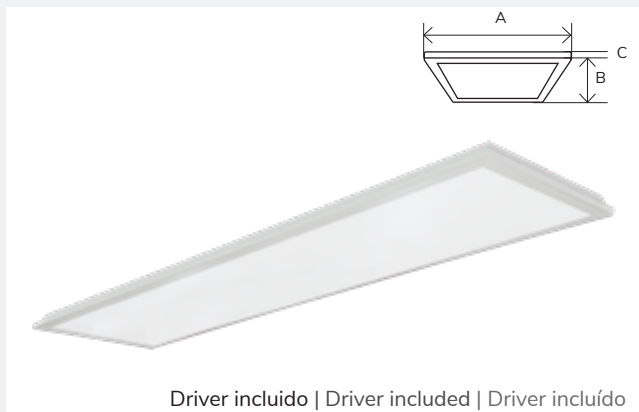

Driver incluido | Driver included | Driver incluído



Con selector de cambio de temp. de color
With color temperature change selector
Com interruptor de seleção de temp. de cor



Sku	Family	mm	kg	Power	Driver	Reg.	Colour Selector	Lumens	Input	€*		
		A	B	C								
*Ecoraee incluida included incluída * IVA no incluido VAT not included IVA não incluído												
F80721	FT-8123	1195	295	32	1,62	36W	Philips	No-Dim	CCT 3.000K 4.000K 6.500K	4.320	220-240V, 50/60Hz	41,67 €
F80722										4.400		41,67 €
F80723										3.600		40,16 €
F80724										4.400		59,53 €
F80725												52,59 €
F80726												58,03 €

Accesorios | Accessories | Acessórios

*Ecoraee incluida | included | incluída
* IVA no incluido | VAT not included | IVA não incluído



FT-8000/F8008 17,32 €*

Kit de superficie para panel 120X30
Surface kit for 120X30 panel
Kit de superficie para painel 120X30



FT-8000/F8013 6,60 €*

Kit de suspensión para panel 120X30
Suspension kit for 120X30 panel
Kit de suspensão para painel 120X30



FT-8000/F8031 19,26 €*

Marco para empotrar para panel 120x30
Recessed frame for 120x30 panel
Moldura de encastrar para painel 120x30

LED PANEL 120X60 PRO UGR

Los paneles UGR LED PRO, brindan una luz ideal para oficinas, tiendas, hoteles, hospitales, escuelas e institutos. Aportando un mayor confort visual con su difusor que asegura una salida luminosa homogénea, asegurando en todos los puntos el factor de deslumbramiento UGR<19.

UGR LED PRO panels provide an ideal light for offices, shops, hotels, hospitals, schools and institutes. Providing greater visual comfort with its diffuser that ensures a homogenous light output, ensuring at all points the glare factor UGR <19.

Os painéis UGR LED PRO fornecem uma luz ideal para escritórios, lojas, hotéis, hospitais, escolas e institutos. Proporcionando maior conforto visual com seu difusor que garante uma saída de luz homogênea, garantindo em todos os pontos o fator de brilho UGR <19.



Con selector de cambio de temp. de color
With color temperature change selector
Com interruptor de seleção de temp. de cor



Sku	Family	mm			kg	Power	Driver	Reg.	Colour Selector	Lumens	Input	€*
		A	B	C								
F80731	FT-8126	1195	595	32	3,4	72W	x2 Philips	No-Dim	CCT 3.000K 4.000K 6.500K	8.640	220-240V, 50/60Hz	94,58 €
F80732						88W				8.800		94,58 €
F80733						60W				7.200		91,55 €
F80734						x2 Lifud	80W	0-10V		8.800		105,71 €
F80735								DALI2/		8.800		98,76 €
F80736												127,32 €

*Ecorae incluida | included | incluída
* IVA no incluido | VAT not included | IVA não incluído

Accesorios | Accessories | Acessórios

*Ecorae incluida | included | incluída
* IVA no incluido | VAT not included | IVA não incluído



FT-8000/F8014 19,73 €*
Kit de superficie para panel 120x60
Surface kit for 120x60 panel
Kit de superficie para painel 120x60



FT-8000/F8032 7,61 €*
Kit de suspensión para panel 120x60
Suspension kit for 120x60 panel
Kit de suspensão para painel 120x60



FT-8000/F8033 20,93 €*
Marco para empotrar para panel 120x60
Recessed frame for 120x60 panel
Moldura de encastrar para painel 120x60

Componentes | Components | Componentes

*Ecoraee incluída | included | incluída
* IVA no incluido | VAT not included | IVA não incluído



F8070/F8071 21,99 €*

Panel Led 36W 596x595x29MM

F8070	4.000K
F8071	6.500K



F8072 34,93 €*

Panel Led 36W 1195x295x32MM



F8073 81,09 €*

Panel Led 72W 1195x595x32MM



FT-8000/F8074 6,74 €*

Philips certa driver 36W



FT-8000/F8079 24,61 €*

Lifud driver ABT 40W TRIAC



FT-8000/F8080 17,66 €*

Lifud driver ABA 40W 0-10V



FT-8000/F8081 23,07 €*

Lifud driver ADD 40W DALI2/PUSH



FT-8000/F8046 6,74 €*

Philips driver 44W Flicker free



FT-8000/F8019 5,23 €*

Lifud driver 30W LF-GIR030YM

Accesorios | Accessories | Acessórios

*Ecoraee incluída | included | incluída
* IVA no incluido | VAT not included | IVA não incluído



FT-6000	F6010	SENSOR CREPUSCULAR 1-10V	16,30 €* _____
FT-7000	F7029	EMERGENCY KIT AC OUT 8-36W	104,90 €* _____
	F7030	EMERGENCY KIT AC OUT 30-50W	195,92 €* _____

BACKLIGHT LED PANEL 60X60

Los paneles ESSENTIAL LED de Filux te permitirán crear un ambiente muy luminoso y actual por su diseño integrado y elegante. La duración de los paneles LED es mucho mayor que la de los paneles convencionales, por eso es una elección recomendada si buscamos un sistema lumínico para nuestra estancia. Alternativa mucho más ecológica.

The Filux ESSENTIAL LED panels will allow you to create a very bright and contemporary environment due to its integrated and elegant design. The length of LED panels is much longer than conventional panels, so it is a recommended choice if we are looking for an ecological light system.

Os painéis ESSENTIAL LED Filux permitem criar um ambiente muito brilhante e moderno devido ao seu design integrado e elegante. A duração dos painéis de LED é maior do que os painéis convencionais, é por isso uma escolha recomendado se procuramos um sistema de luz ecológico.



3
YEAR
WARRANTY

25.000H

CRI
>80

120°

PF
0,9

IP20

100LM/W

**STARSENSE
SIGNIFY**

SMD

6PCS

Lightbulb icon

Lightning bolt icon

Model	SKU	mm			kg	Power	C.Temp	Lumens	Input	€*
		A	B	C						
FT-8600	F8075	595	595	29	1,2	42W	4.000K	4.000	220-240V, 50/60Hz	18,57 €
	F8076						6.000K			

Driver incluido | Driver included | Driver incluído

Accesorios | Accessories | Acessórios

*Ecorae incluida | included | incluída
* IVA no incluido | VAT not included | IVA não incluído

FT-8000/F8007 **12,88 €*
12,88 €***

Kit de superficie para panel 60x60
Surface kit for 60x60 panel
Kit de superfície para panel 60x60

FT-8000/F8009 **6,71 €*
6,71 €***

Kit de suspensión para panel 60x60
Suspension kit for 60x60 panel
Kit de suspensão para painel 60x60

FT-8000/F8030 **15,72 €*
15,72 €***

Marco para empotrar para panel 60x60
Recessed frame for 60x60 panel
Moldura de encastrar para painel 60x60

BACKLIGHT LED PANEL 120X30

Los paneles BACKLIGHT LED de Filux te permitirán crear un ambiente muy luminoso y actual por su diseño integrado y elegante. La duración de los paneles LED es mucho mayor que la de los paneles convencionales, por eso es una elección recomendada si buscamos un sistema lumínico para

The Filux LED BACKLIGHT panels will allow you to create a very bright and contemporary environment due to its integrated and elegant design. The length of LED panels is much longer than conventional

Os painéis LED BACKLIGHT de Filux, permitem criar um ambiente muito brilhante e moderno devido ao seu design integrado e elegante. A sua aplicação é ampla e variada. A duração dos painéis de LED é maior do que os painéis convencionais.

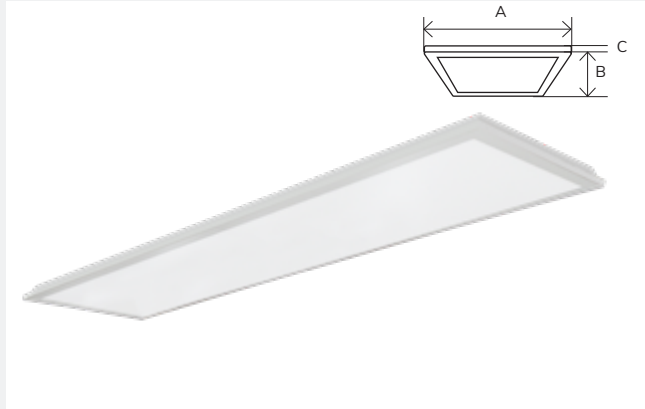

3
YEAR
WARRANTY

25.000H

CRI
>80

110°

PF
0,9

IP40

100LM/W



SMD



Model	SKU	mm			kg	Power	C.Temp	Lumens	Driver	Input	€*
		A	B	C							
FT-8123	F8052	1195	295	32	1,2	40W	4.000	4.000	FILUX	220-240V, 50/60Hz	24,20 €
	F8053						6.000				
	F8077					4.000	4.000	STARSENSE SIGNIFY			
	F8078								6.000		24,19 €

*Ecoraee incluida | included | incluída
* IVA no incluido | VAT not included | IVA não incluído

Driver incluido | Driver included | Driver incluído

Accesorios | Accessories | Acessórios

*Ecoraee incluida | included | incluída
* IVA no incluido | VAT not included | IVA não incluído



FT-8000/F8008 **17,32 €***

Kit de superficie para panel 120X30
Surface kit for 120X30 panel
Kit de superfície para painel 120X30



FT-8000/F8013 **6,60 €***

Kit de suspensión para panel 120X30
Suspension kit for 120X30 panel
Kit de suspensão para painel 120X30



FT-8000/F8031 **19,26 €***

Marco para empotrar para panel 120x30
Recessed frame for 120x30 panel
Moldura de encastrar para painel 120x30



Downlights

Downlights

Downlights





ROUND LED DOWNLIGHT

Ideales para la iluminación ambiental, reemplazo ideal de luminarias fluorescentes. El producto perfecto para la iluminación de todo tipo de interiores donde se busque dirigir la luz hacia algún punto en concreto, tanto en viviendas particulares, como para usos profesionales en comercios, restaurantes y tiendas, entre otros. Este downlight cuenta con la posibilidad de elegir la temperatura de color.

Ideal for ambient lighting, ideal replacement for fluorescent luminaires. The perfect product for the illumination of all types of interiors where it is sought to direct the light to some specific point, in private houses, for professional uses in shops, restaurants and shops, among others. This downlight offers the possibility to change the color temperature.

Ideais para iluminação ambiente. Ideal para a substituição de downlights fluorescentes. Produto perfeito para iluminação de todos os tipos de interiores onde se pretende direcionar a luz para algum ponto em concreto, tanto em uso residencial ou em uso profissional, tais como, em lojas, restaurantes, entre outros este downlight tem a possibilidade de escolher a temperatura de cor.

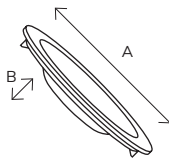

3
YEAR
WARRANTY

25.000H

CRI
>80

110°

IP20

K
3000
4000
6500
ALL IN ONE

SMD



Model	SKU	mm			Power	Lumens	Input	Units p/pack	€*
		A	B	Cut					
FT-9005	F9101	Ø 85	25	Ø 71	5W	400 lm	220-240V, 50/60Hz	100	2,62 €
FT-9006	F9102	Ø 117		Ø 98	6W	510 lm		100	3,24 €
FT-9009	F9103	Ø 143		Ø 120	9W	810 lm		50	4,01 €
FT-9012	F9104	Ø 173	26	Ø 150	12W	1.200 lm		40	4,89 €
FT-9018	F9105	Ø 221	27	Ø 195	18W	1.800 lm			6,71 €
FT-9024	F9106	Ø 295	28	Ø 270	24W	2.400 lm		20	10,50 €

*Ecoraee incluida | included | incluída

* IVA no incluído | VAT not included | IVA não incluído



Con selector de cambio de temp. de color
With color temperature change selector
Com interruptor de seleção de temp. de cor

SQUARE LED DOWNLIGHT

Ideales para la iluminación ambiental, reemplazo ideal de luminarias fluorescentes. El producto perfecto para la iluminación de todo tipo de interiores donde se busque dirigir la luz hacia algún punto en concreto, tanto en viviendas particulares, como para usos profesionales en comercios, restaurantes y tiendas, entre otros. Este downlight cuenta con la posibilidad de elegir la temperatura de color.

Ideal for ambient lighting, ideal replacement for fluorescent luminaires. The perfect product for the illumination of all types of interiors where it is sought to direct the light to some specific point, in private houses, for professional uses in shops, restaurants and shops, among others. This downlight offers the possibility to change the color temperature.

Ideais para iluminação ambiente. Ideal para a substituição de downlights fluorescentes. Produto perfeito para iluminação de todos os tipos de interiores onde se pretende direcionar a luz para algum ponto em concreto, tanto em uso residencial ou em uso profissional, tais como, em lojas, restaurantes, entre outros este downlight tem a possibilidade de escolher a temperatura de cor.



- 3**
YEAR
WARRANTY
- 25.000H
- CRI**
>80
- 110°
- IP20
- K**
3000
4000
6500
ALL IN ONE
- SMD
-
-
-

Model	Sku	mm			Power	Lumens	Input	Units p/pack	€*
		A	B	Cut					
FT-9006	F9107	119x119	26	100x100	6W	510 lm	220-240V, 50/60Hz	100	3,55 €
FT-9009	F9108	141x141		120x120	9W	810 lm		50	4,11 €
FT-9012	F9109	173x173		145x145	12W	1.200 lm		40	5,14 €
FT-9018	F9110	220x220		193x193	18W	1.800 lm			7,31 €
FT-9024	F9111	295x295	29	265x265	24W	2.400 lm		20	11,32 €

*Ecoraee incluida | included | incluída
* IVA no incluido | VAT not included | IVA não incluído

Con selector de cambio de temp. de color
With color temperature charge selector
Com interruptor de seleção de temp. de cor

ROUND LED DOWNLIGHT SURFACE

Ideales para la iluminación ambiental, reemplazo ideal de luminarias fluorescentes. El producto perfecto para la iluminación de todo tipo de interiores donde se busque dirigir la luz hacia algún punto en concreto, tanto en viviendas particulares, como para usos profesionales en comercios, restaurantes y tiendas, entre otros. Este downlight cuenta con la posibilidad de elegir la temperatura de color.

Ideal for ambient lighting, ideal replacement for fluorescent luminaires. The perfect product for the illumination of all types of interiors where it is sought to direct the light to some specific point, in private houses, for professional uses in shops, restaurants and shops, among others. This downlight offers the possibility to change the color temperature.

Ideais para iluminação ambiente. Ideal para a substituição de downlights fluorescentes. Produto perfeito para iluminação de todos os tipos de interiores onde se pretende direcionar a luz para algum ponto em concreto, tanto em uso residencial ou em uso profissional, tais como, em lojas, restaurantes, entre outros este downlight tem a possibilidade de escolher a temperatura de cor.



3
YEAR
WARRANTY

25.000H

CRI
>80

110°

IP20

K 3000
4000
6500
ALL IN ONE

SMD

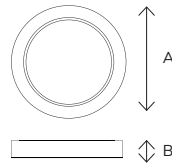

Model	SKU	mm	Power	Lumens	Input	Units p/pack	€*
-------	-----	----	-------	--------	-------	--------------	----

A B

*Ecoraee incluida | included | incluída

* IVA no incluido | VAT not included | IVA não incluído

FT-9012	F9112	Ø 175	34	12W	1.200 lm	220-240V, 50/60Hz	40	5,49 €
FT-9018	F9113	Ø 224		18W	1.800 lm			7,79 €
FT-9024	F9114	Ø 299		24W	2.400 lm	20	12,40 €	



Con selector de cambio de temp. de color
With color temperature change selector
Com interruptor de seleção de temp. de cor

SQUARE LED DOWNLIGHT SURFACE

Ideales para la iluminación ambiental, reemplazo ideal de luminarias fluorescentes. El producto perfecto para la iluminación de todo tipo de interiores donde se busque dirigir la luz hacia algún punto en concreto, tanto en viviendas particulares, como para usos profesionales en comercios, restaurantes y tiendas, entre otros. Este downlight cuenta con la posibilidad de elegir la temperatura de color.

Ideal for ambient lighting, ideal replacement for fluorescent luminaires. The perfect product for the illumination of all types of interiors where it is sought to direct the light to some specific point, in private houses, for professional uses in shops, restaurants and shops, among others. This downlight offers the possibility to change the color temperature.

Ideais para iluminação ambiente. Ideal para a substituição de downlights fluorescentes. Produto perfeito para iluminação de todos os tipos de interiores onde se pretende direcionar a luz para algum ponto em concreto, tanto em uso residencial ou em uso profissional, tais como, em lojas, restaurantes, entre outros este downlight tem a possibilidade de escolher a temperatura de cor.



3
YEAR
WARRANTY

25.000H

CRI
>80

110°

IP20

K ³⁰⁰⁰ ⁴⁰⁰⁰ ⁶⁵⁰⁰
ALL IN ONE

SMD

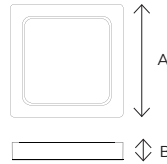

Model	SKU	mm	Power	Lumens	Input	Units p/pack	€*
		A B					
FT-9012	F9115	173x173	12W	1.200 lm	220-240V, 50/60Hz	40	7,09 €
FT-9018	F9116	226x226	18W	1.800 lm			8,70 €
FT-9024	F9117	298x298	24W	2.400 lm		20	13,36 €



Con selector de cambio de temp. de color
With color temperature change selector
Com interruptor de seleção de temp. de cor

ROUND DOWNLIGHT LED PRO

Ideales para la iluminación ambiental, reemplazo ideal de luminarias fluorescentes. El producto perfecto para la iluminación de todo tipo de interiores donde se busque dirigir la luz hacia algún punto en concreto, tanto en viviendas particulares, como para usos profesionales en comercios, restaurantes y tiendas, entre otros. Este downlight cuenta con la posibilidad de elegir la temperatura de color.

Ideal for ambient lighting, ideal replacement for fluorescent luminaires. The perfect product for the illumination of all types of interiors where it is sought to direct the light to some specific point, in private houses, for professional uses in shops, restaurants and shops, among others. This downlight offers the possibility to change the color temperature.

Ideais para iluminação ambiente. Ideal para a substituição de downlights fluorescentes. Produto perfeito para iluminação de todos os tipos de interiores onde se pretende direcionar a luz para algum ponto em concreto, tanto em uso residencial ou em uso profissional, tais como, em lojas, restaurantes, entre outros este downlight tem a possibilidade de escolher a temperatura de cor.



5
YEAR
WARRANTY

50.000H

CRI
>80

85°

EYE
COMFORT

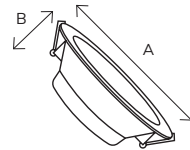

IP44 Front

IP20 Back

K ³⁰⁰⁰
⁴⁰⁰⁰
⁶⁵⁰⁰
ALL IN ONE

SMD

PHILIPS



Model	SKU	mm			Power	Lumens	Input	Units p/pack	€*
		A	B	Cut					
FT-9008	F9118	Ø 90	34	Ø 78	8W	800 lm	220-240V, 50/60Hz	100	18,03 €
FT-9015	F9119	Ø 135	36	Ø 122	14W	1.400 lm		50	21,16 €
FT-9020	F9120	Ø 186	45	Ø 170	20W	2.000 lm		30	22,80 €
FT-9032	F9121	Ø 230		Ø 212	32W	3.200 lm			28,48 €



Con selector de cambio de temp. de color
With color temperature change selector
Com interruptor de seleção de temp. de cor

SUPLEMENTO DRIVER LIFUD

Model	Sku	Brand	Model	Power	Reg.	To	€*
*Ecoraee incluída included incluída							
* IVA no incluído VAT not included IVA não incluído							
FT-9008	F9124	LIFUD	ABT	8W	TRIAC	F9118	12,38 €
	F9125		AAA		0-10V		20,64 €
	F9126		ADD	9W	DALI2+PUSH		19,33 €
FT-9015	F9127		ABT	14W	TRIAC	F9119	13,60 €
	F9128		ABA	12W	0-10V		14,46 €
	F9129		ADD	13W	DALI2+PUSH		20,48 €
FT-9020	F9130		AAT	20W	TRIAC	F9120	26,30 €
	F9131		ABA		0-10V		15,68 €
	F9132		AAD		DALI2+PUSH		26,50 €
FT-9032	F9133		AAT	30W	TRIAC	F9121	29,06 €
	F9134		ABA		0-10V		16,90 €
	F9135		ADD		DALI2+PUSH		21,70 €

LUMINARIA LINEAL. Superficie/Suspensión

Ideales para la iluminación ambiental, reemplazo ideal de luminarias fluorescentes. El producto perfecto para la iluminación de todo tipo de interiores donde se busque dirigir la luz hacia algún punto en concreto, tanto en viviendas particulares, como para usos profesionales en comercios, restaurantes y tiendas, entre otros. Este downlight cuenta con la posibilidad de elegir la temperatura de color.

Ideal for ambient lighting, ideal replacement for fluorescent luminaires. The perfect product for the illumination of all types of interiors where it is sought to direct the light to some specific point, in private houses, for professional uses in shops, restaurants and shops, among others. This downlight offers the possibility to change the color temperature.

Ideais para iluminação ambiente. Ideal para a substituição de downlights fluorescentes. Produto perfeito para iluminação de todos os tipos de interiores onde se pretende direcionar a luz para algum ponto em concreto, tanto em uso residencial ou em uso profissional, tais como, em lojas, restaurantes, entre outros este downlight tem a possibilidade de escolher a temperatura de cor.



5
YEAR
WARRANTY

50.000H

CRI
>80

110°

**POWER
SELECTABLE**

IP20

SMD

120LM/W



Model	SKU	mm			Power	Colour Selector	Input	Units p/ pack	€*
		A	B	C					
FT-9015	F9100	1288	50	70	30W/45W/60W	CCT 3.000K 4.200K 6.500K	220-240V, 50/60Hz	4	87,75 €

*Ecoraee incluída | included | incluída
* IVA no incluido | VAT not included | IVA não incluído



Con selector de cambio de potencia y de temp. de color
With power and color temperature change selector
Com seletor de mudança de potência e temperatura de cor

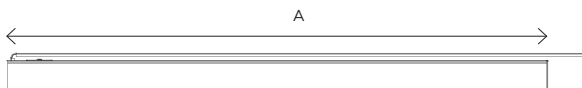

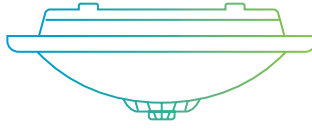

Plafones led
Led ceiling lights
Luzes de teto led

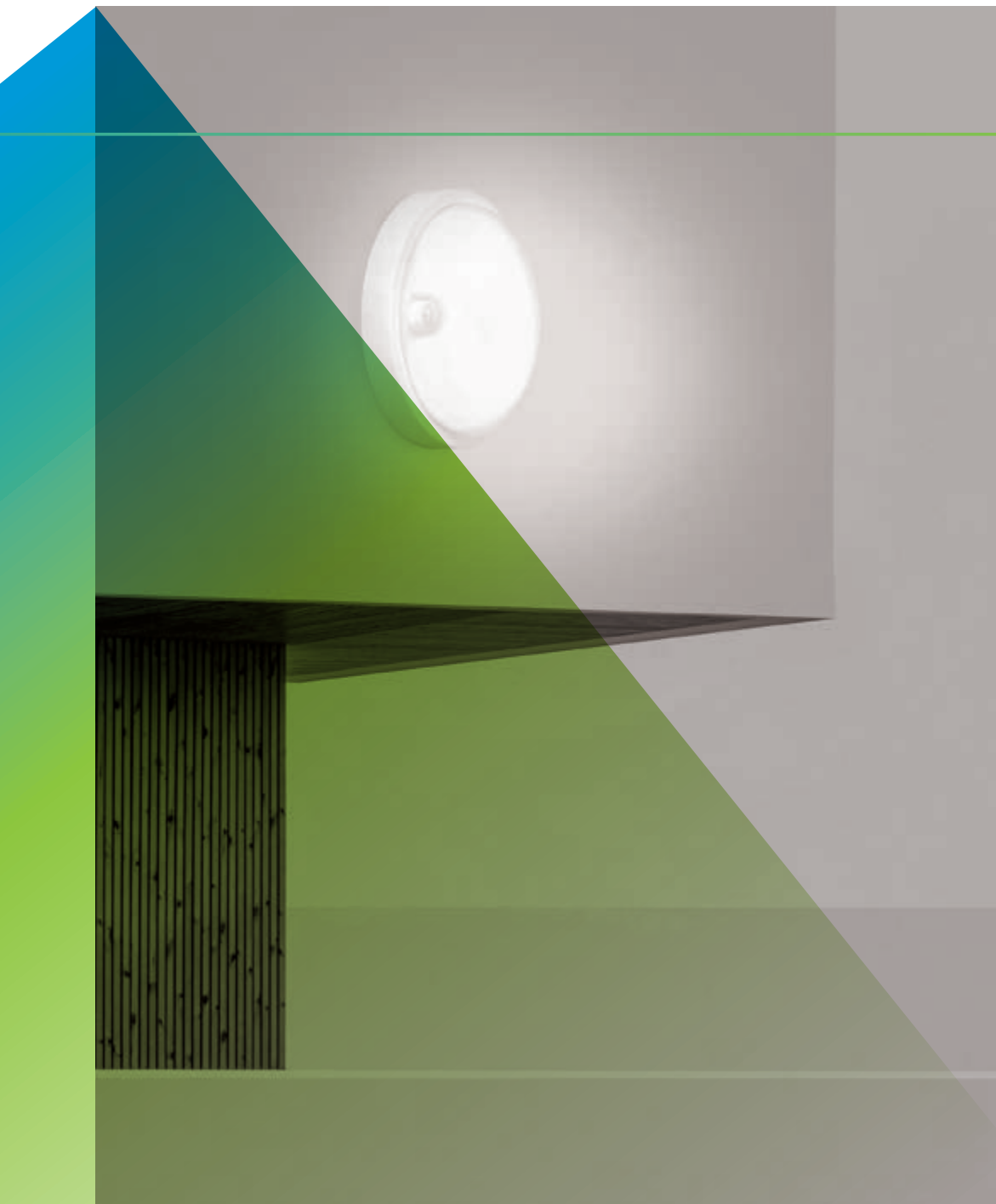

PLAFONES LED | LED CEILING LIGHTS | LUZES DE TETO LED

ROUND LED CEILING LIGHT SURFACE

Ideales para la iluminación ambiental, reemplazo ideal de luminarias fluorescentes. El producto perfecto para la iluminación de todo tipo de interiores donde se busque dirigir la luz hacia algún punto en concreto, tanto en viviendas particulares, como para usos profesionales en comercios, restaurantes y tiendas, entre otros. Este downlight cuenta con la posibilidad de elegir la temperatura de color.

Ideal for ambient lighting, ideal replacement for fluorescent luminaires. The perfect product for the illumination of all types of interiors where it is sought to direct the light to some specific point, in private houses, for professional uses in shops, restaurants and shops, among others. This downlight offers the possibility to change the color temperature.

Ideais para iluminação ambiente. Ideal para a substituição de downlights fluorescentes. Produto perfeito para iluminação de todos os tipos de interiores onde se pretende direcionar a luz para algum ponto em concreto, tanto em uso residencial ou em uso profissional, tais como, em lojas, restaurantes, entre outros este downlight tem a possibilidade de escolher a temperatura de cor.



5
YEAR
WARRANTY

30.000H

CRI
>80

300°

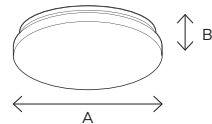

**POWER
SELECTABLE**

IP20

K
3000
4000
6500
ALL IN ONE

SMD



Model	SKU	mm		Power	Lumens	Input	Units p/pack	€*
		A	B					
FT-9015	F9122	Ø 310	70	16W 20W 24W	1.440lm 1.800lm 2.160lm	220-240V, 50/60Hz	10	19,68 €

*Ecorae incluida | included | incluída
* IVA no incluido | VAT not included | IVA não incluído



Con selector de cambio de potencia y de temp. de color
With power and color temperature change selector
Com seletor de mudança de potência e temperatura de cor

SURFACE W/MOTION PIR SENSOR

Ideales para la iluminación ambiental, reemplazo ideal de luminarias fluorescentes. El producto perfecto para la iluminación de todo tipo de interiores donde se busque dirigir la luz hacia algún punto en concreto, tanto en viviendas particulares, como para usos profesionales en comercios, restaurantes y tiendas, entre otros. Este downlight cuenta con la posibilidad de elegir la temperatura de color.

Ideal for ambient lighting, ideal replacement for fluorescent luminaires. The perfect product for the illumination of all types of interiors where it is sought to direct the light to some specific point, in private houses, for professional uses in shops, restaurants and shops, among others. This downlight offers the possibility to change the color temperature.

Ideais para iluminação ambiente. Ideal para a substituição de downlights fluorescentes. Produto perfeito para iluminação de todos os tipos de interiores onde se pretende direcionar a luz para algum ponto em concreto, tanto em uso residencial ou em uso profissional, tais como, em lojas, restaurantes, entre outros este downlight tem a possibilidade de escolher a temperatura de cor.



5
YEAR
WARRANTY

30.000H

CRI
>80

300°

**POWER
SELECTABLE**

**PIR
SENSOR**

IP20

**K 3000
4000
6500
ALL IN ONE**

SMD

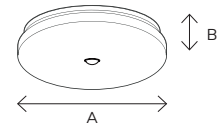

Model	SKU	mm		Power	Lumens	Input	Units p/pack	€*
		A	B					
FT-9030	F9123	Ø 310	70	16W 20W 24W	1.440lm 1.800lm 2.160lm	220-240V, 50/60Hz	10	28,05 €

*Ecoraee incluída | included | incluída
* IVA no incluido | VAT not included | IVA não incluído



Con selector de cambio de potencia y de temp. de color
With power and color temperature change selector
Com seletor de mudança de potência e temperatura de cor

ROUND LED DOWNLIGHT



3
YEAR
WARRANTY

30.000H

CRI
>80

120°

IP65

-25° | +45°

SMD

24 PCS



Model	Sku	Color	mm	kg	Power	C.Temp	Lumens	Input	€*
-------	-----	-------	----	----	-------	--------	--------	-------	----

*Ecorae incluida | included | incluida * IVA no incluido | VAT not included | IVA não incluído

FT-9015	F9086	White	Ø190x45	0,30	15W	3.000K	1.000	220-240V, 50/60Hz	12,60 €
	F9087					4.000K			
	F9088	Black				3.000K			

Fotometría | Photometrie | Fotometria

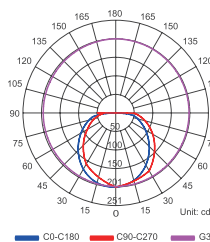

120°

Ángulo apertura
Beam angle
Ângulo de abertura

SQUARE LED DOWNLIGHT

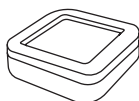

3
YEAR
WARRANTY

30.000H

CRI
>80

120°

IP65

-25° | +45°

SMD

24 PCS



Model	SKU	Color	mm	kg	Power	C.Temp	Lumens	Input	€*
*Ecoraee incluida included incluida * IVA no incluido VAT not included IVA não incluído									
FT-9015	F9090	White	190x190x45	0,37	15W	3.000K	1.000	220-240V, 50/60Hz	12,93 €
	F9092	Black				3.000K			
	F9093					4.000K			

Fotometría | Photometrie | Fotometria

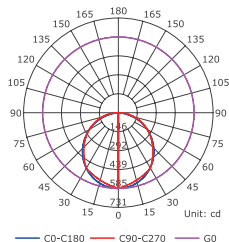

120°

Ángulo apertura
Beam angle
Ângulo de abertura

SURFACE LED WALL LIGHT



3
YEAR
WARRANTY

30.000H

CRI
>80

120°

IP54

-25° | +45°

SMD

20 PCS



Model	SKU	Color	mm	kg	Power	C.Temp	Lumens	Input	€*
*Ecoraee incluída included incluída * IVA no incluído VAT not included IVA não incluído									
FT-9015	F9094	Black	Ø220x68	0,40	18W	3.000K	1.260	220-	14,52 €

Fotometría | Photometrie | Fotometria

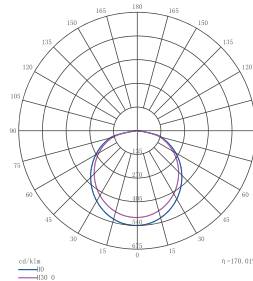

120°

Ángulo apertura
Beam angle
Ângulo de abertura

LED CEILING LIGHT



3
YEAR
WARRANTY

30.000H

CRI
>80

120°

8 PCS

IP54

IK07

-25° | +45°

PF
>0,9

SMD



Model	SKU	Color	mm	kg	Power	C.Temp	Lumens	Input	€*
*Ecorae incluida included incluida * IVA no incluido VAT not included IVA não incluído									
FT-9015	F9098	Grey	Ø350x60	0,92	28W	3.000K	2.400	170-	33,30 €

Fotometría | Photometrie | Fotometria

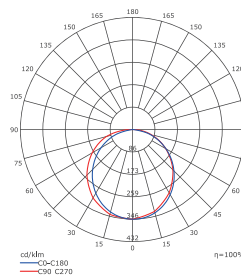

120°

Ángulo apertura
Beam angle
Ângulo de abertura

LED BULKHEAD LIGHT

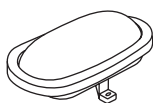

3
YEAR
WARRANTY

30,000H

CRI
>80

120°



IP64



-25° | +45°



SMD



20 PCS



Model	SKU	Color	mm	kg	Power	C.Temp	Lumens	Input	€*
*Ecoraee incluída included incluída * IVA no incluido VAT not included IVA não incluído									
FT-9015	F9096	White	216x142x79	0,18	11W	4.000K	770	220-240V, 50/60Hz	8,86 €

Fotometría | Photometrie | Fotometria

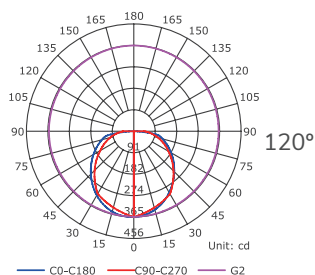

120°

Ángulo apertura
Beam angle
Ângulo de abertura

LED BULKHEAD LIGHT

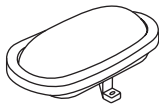

3
YEAR
WARRANTY

30,000H

CRI
>80

120°

IP64

-25° | +45°

SMD

20 PCS



Model	SKU	Color	mm	kg	Power	C.Temp	Lumens	Input	€*
*Ecoraee incluída included incluída * IVA no incluido VAT not included IVA não incluído									
FT-9015	F9097	Black	216x142x79	0,18	11W	4.000K	770	220-240V, 50/60Hz	8,86 €

Fotometría | Photometrie | Fotometria

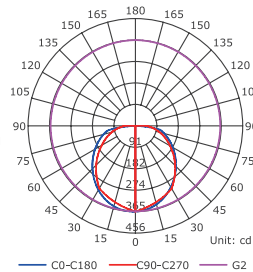

120°

Ángulo apertura
Beam angle
Ângulo de abertura

SURFACE W/MOTION PIR SENSOR

Plafón con sensor de movimiento, de fácil instalación, sin parpadeos, gran tolerancia a temperatura extremas. Perfecto para grandes áreas. Lámpara automática con sensor de ahorro energético. Reúne automatismo, comodidad, seguridad, ahorro de energía y funciones prácticas.

Ceiling with motion sensor, easy installation, no flickering, great tolerance to extreme temperatures Perfect for large areas. Automatic lamp with energy-saving sensor. Combination of comfort, safety, energy saving and practical functions.

Plafonier de teto com sensor de movimento, fácil instalação, sem cintilação, grande tolerância a temperaturas extremas. Perfeito para grandes áreas Lâmpada automática com sensor de poupança de energia. Mais conforto, segurança, economia de energia e funções práticas.

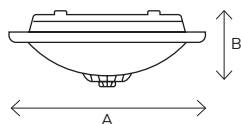

2x
E27

3
YEAR
WARRANTY



Model	SKU	mm	kg	Power	Input	Delay Time	Distance Detect.	Speed	Ambient Light	Install. Height	€*
-------	-----	----	----	-------	-------	------------	------------------	-------	---------------	-----------------	----

Retardo
Atraso

Detec. distancia
Detec. distancia

Velocidad
Velocidade

Luz Ambiente
Luz Ambiente

Altura de
instalación
Altura de
instalação

		A	B	*Ecorae incluida included incluída * IVA no incluido VAT not included IVA não incluído								
FT-9230	F9203	Ø 300	96,8	0,66	2X E27	220- 240V, 50/60Hz	Min. 10 sec ± 3sec Max. 3min ± 30 sec	6m Max (<24°C)	0,6-1,5m/s	<3-2000lux (Aj/adj)	2,2-4m	20,00 €



Sensores

Sensors

Sensores



INDOOR SURFACE-RECESSED PIR SENSOR

FT-9210 consta de un buen detector de sensibilidad y circuito integrado. Reúne automatismo, comodidad, seguridad, ahorro de energía y funciones prácticas. Utiliza la energía infrarroja del ser humano como fuente de señal de control y puede iniciar la carga de una vez cuando se entra en el campo de detección. Puede identificar día y noche automáticamente.

FT-9210 consists of a good sensitivity detector and integrated circuit. It combines automatism, comfort, safety, energy saving and practical functions. It uses the human's infrared energy as the control signal source and can start charging once when entering the detection field. You can automatically identify day and night.

FT-9210 consiste em um bom detector de movimento combina automação, conforto, segurança, economia de energia e funções práticas. Usa a energia infravermelha do ser humano como uma fonte de sinal de controle e se pode iniciar a partir do momento que detecta algo no campo de detecção. Permite identificar o dia e a noite automaticamente.

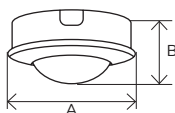

3
YEAR
WARRANTY



Model	SKU	mm	kg	Power	Input	Delay Time	Distance Detect.	Speed	Ambient Light	Install. Height	€*
-------	-----	----	----	-------	-------	------------	------------------	-------	---------------	-----------------	----

Retardo
Atraso

Detec. distancia
Detec. distancia

Velocidad
Velocidade

Luz Ambiente
Luz Ambiente

Altura de
instalación
Altura de
instalação

		A	B	*Ecoraee incluida included incluída * IVA no incluido VAT not included IVA não incluído								
FT-9210	F9201	Out Ø 80 In Ø 61,5	Out 39,6 In 37,1	0,18	Max. 800W 400W	220- 240V, 50/60Hz	Min. 10 sec ± 3sec Max. 30min ± 2min	8m Max (<24°C)	0,6-1,5m/s	<3-2000lux (Aj/adj)	2,2-4m	10,34 €

OUTDOOR SURFACE PIR SENSOR

FT-9220 Detector de buena sensibilidad y circuito integrado. Reúne automatismo, comodidad, seguridad, ahorro de energía y funciones prácticas. Puede identificar día y noche automáticamente. Es fácil de instalar y utilizar ampliamente.

FT-9220 Good sensitivity detector and integrated circuit. It gathers automatism, convenience, safety, saving-energy and practical functions. It can identify day and night automatically. It is easy to install and used widely.

FT-9220 detector de boa sensibilidade. Combina automação, conforto, segurança, economia energia e funções práticas. Pode identificar dia e noite automaticamente é fácil de instalar e usar.

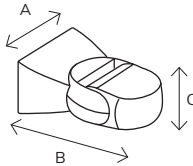

3
YEAR
WARRANTY

MOTION
SENSOR

IP65



180°

50 PCS



Model	Sku	mm	kg	Power	Input	Delay Time	Distance Detect.	Speed	Ambient Light	Install. Height	€*
-------	-----	----	----	-------	-------	------------	------------------	-------	---------------	-----------------	----

Retardo Atraso	Detec. distancia Detec. distancia	Velocidad Velocidade	Luz Ambiente Luz Ambiente	Altura de instalación Altura de instalação
-------------------	--------------------------------------------	-------------------------	------------------------------------	-----------------------------------------------------

		A	B	C	*Ecoraee incluida included incluída * IVA no incluido VAT not included IVA não incluído								
FT-9220	F9202	80	119,5	51,5	0,18	 Max. 1200W  300W	220-240V, 50/60Hz	Min. 10 sec ± 3sec Max. 15min ± 2min	12m Max (<24°C)	0,6-1,5m/s	<3-2000lux (Aj/adj)	1,8-2,5 m	11,01 €

SURFACE PIR SENSOR

F9204-F9205 Buen detector de sensibilidad y circuito integrado. Reúne automatismo, conveniencia, seguridad, ahorro de energía y funciones prácticas. Utiliza la energía infrarroja del ser humano como fuente de señal de control y puede iniciar la carga de inmediato cuando uno entra al campo de detección. Puede identificar día y noche automáticamente. Es fácil de instalar y se usa ampliamente.

F9204-F9205 Good sensitivity detector and integrated circuit. It gathers automatism, convenience, safety, saving-energy and practical functions. It utilizes the infrared energy from human as control-signal source and it can start the load at once when one enters detection field. It can identify day and night automatically. It is easy to install and used widely.

F9204-F9205 Detector de movimento por infravermelho passivo (IR). Mede a luz infravermelha que é irradiada pelos objectos existentes no seu campo. Geralmente são utilizados em alarmes de segurança e/ou aplicações de iluminação automática.

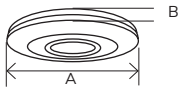

3
YEAR
WARRANTY

MOTION
SENSOR

IP20

360°

50 PCS



Model	SKU	Color	mm	kg	Power	Input	Delay Time	Distance Detect.	Speed	Ambient Light	Install. Height	€*
-------	-----	-------	----	----	-------	-------	------------	------------------	-------	---------------	-----------------	----

Retardo	Detec. distancia	Velocidad	Luz Ambiente	Altura de instalación
Atraso	Detec. distancia	Velocidade	Luz Ambiente	Altura de instalação

		A	B	*Ecorae incluida included incluída * IVA no incluido VAT not included IVA não incluído									
FT-9240	F9204	Black	∅ 115	24,3	0,18	Max. 2000W 1000W	220-240V, 50/60Hz	Min. 10 sec ± 3sec	8m Max (<24°C)	0,6-1,5m/s	<3-2000lux (Aj/adj)	2,2-4m	9,74 €
	F9205	White						Max. 15min ± 2min					

LIGHT SENSOR. PHOTOCELL

El sensor de luz F9206 puede encender o apagar la luz automáticamente de acuerdo con la luz ambiental. La temperatura ambiente y la humedad no pueden afectarlo. No solo es conveniente sino también práctico; puede controlar la carga trabajando solo de noche. Se utiliza para luz de carretera, luz de jardín, etc.

F9206 Light sensor can turn on or turn off light automatically according to ambient-light. Ambient temperature and humidity can't affect it. It is not only convenient but also practical; it can control the load working only at night. It is used for road light, garden light etc.

O detector de luz F9206, permite ligar ou desligar a luz automaticamente, dependendo da luz existente na sua zona de actuação. A temperatura ambiente e a quantidade de humidade podem afectar o seu modo de funcionamento. Geralmente são usados em iluminação exterior, em jardins, etc...

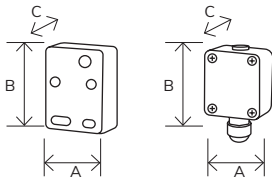

3
YEAR
WARRANTY

**MOTION
SENSOR**

50 PCS



Model	SKU	mm			Rated current	Input	Temperature	Humidity	Ambient Light	€*
					Corriente nominal Corrente nominal		Temperatura Temperatura	Humedad Umidade	Luz Ambiente Luz Ambiente	
		A	B	C	*Ecoraee incluida included incluída * IVA no incluido VAT not included IVA não incluído					
FT-9240	F9206	48 42,1	63,4 47,9	27,3 28,8	15A	220- 240V, 50Hz	-20 ~+40°C	<93%RH	<2-100lux (Aj/ adj)	10,45 €

RECESSED MICROWAVE INDOOR SENSOR

F9207 Molde de sensor de microondas con onda electromagnética de alta frecuencia (5.8GHz) y circuito integrado. Automatismo, comodidad, seguridad y ahorro de energía. Amplio campo de detección. Funciona con el movimiento humano. Cuando uno entra al campo de detección, puede iniciar la carga de inmediato e identificar automáticamente día y noche. La detección es posible a través de puertas, paneles de vidrio o paredes delgadas.

F9207 Microwave sensor mould with high-frequency electro-magnetic wave (5.8GHz) and integrated circuit. Automatism, convenience, safety, and saving-energy. Wide detection field. It works by receiving human motion. When one enters the detection field, it can start the load at once and identify automatically day and night. Detection is possible to go through doors, panes of glass or thin walls.

Detector de movimento por Micro-ondas F9207. Detecta movimento como um radar, detecta as várias mudanças de estado reflectidas devido ao movimento de um objecto resultando num sinal e assim fazer o modo on ou off. Geralmente são usados para acionar as luzes da rua ou de interior, em halls, corredores, escadas, ect.

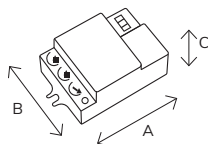

3
YEAR
WARRANTY

MOTION
SENSOR

IP20



180°x360°

100 PCS



Model	SKU	mm	Power	Input	Delay Time	Distance Detect.	Speed	Ambient Light	Install. Height	€*
-------	-----	----	-------	-------	------------	------------------	-------	---------------	-----------------	----

Retardo / Atraso Detec. distancia / Detec. distancia Velocidad / Velocidade Luz Ambiente / Luz Ambiente Altura de instalación / Altura de instalação

		A	B	C	*Ecoraee incluida included incluída * IVA no incluido VAT not included IVA não incluído							
FT-9240	F9207	54,5	39,4	25	 Max. 1200W  300W	220-240V, 50/60Hz	Min. 10sec ± 3sec Max. 12min ± 1min	Wall: 5-15m (adjustable) Ceiling: 1-8m (radius), adjustable	0,6-1,5m/s	<3-2000lux (Aj/adj)	Wall 5-15m (Aj/adj) Ceiling: 1-8m (radius) (Aj/adj)	10,48 €

RECESSED PIR SENSOR

F9208 Detector de buena sensibilidad y circuito integrado. Reúne automatismo, comodidad, seguridad y ahorro de energía. Utiliza la energía infrarroja del ser humano como fuente de señal de control y puede iniciar la carga de inmediato cuando uno entra al campo de detección. Puede identificar día y noche automáticamente. Es fácil de instalar y sencillo de usar.

F9208 Good sensitivity detector and integrated circuit. It gathers automatism, convenience, safety, saving-energy and practical functions. It utilizes the infrared energy from human as control-signal source and it can start the load at once when one enters detection field. It can identify day and night automatically. It is easy to install and used widely.

F 9208 Detector de movimento por infravermelho passivo (IR). Mede a luz infravermelha que é irradiada pelos objectos existentes no seu campo. Geralmente são utilizados em alarmes de segurança e/ou aplicações de iluminação automática.

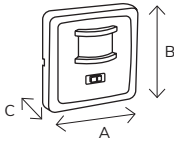

3
YEAR
WARRANTY

MOTION
SENSOR

IP20

160°

100 PCS



Model	SKU	mm	Power	Input	Delay Time	Distance Detect.	Speed	Ambient Light	Install. Height	€*
-------	-----	----	-------	-------	------------	------------------	-------	---------------	-----------------	----

Retardo Detec. distancia Velocidad Luz Ambiente Altura de
Atraso Detec. distancia Velocidade Luz Ambiente Altura de
instalação

		A	B	C	*Ecorae incluida included incluída * IVA no incluido VAT not included IVA não incluído							
FT-9240	F9208	82	82	24,7	Max. 500W 200W	220-240V, 50/60Hz	Min. 10sec ± 3sec Max. 7min ± 2min	9m Max (<24°C)	0,6-1,5m/s	<3-2000lux (Aj/adj)	1-1,8m	10,13 €

PIR SENSOR WALL LIGHT

F9209 Buen detector de sensibilidad y circuito integrado. Reúne automatismo, conveniencia, seguridad, ahorro de energía y funciones prácticas. Utiliza la energía infrarroja del ser humano como fuente de señal de control y puede iniciar la carga de inmediato cuando uno entra al campo de detección. Puede identificar día y noche automáticamente. Es fácil de instalar y se usa ampliamente.

F9209 Good sensitivity detector and integrated circuit. It gathers automatism, convenience, safety, saving-energy and practical functions. It utilizes the infrared energy from human as control-signal source and it can start the load at once when one enters detection field. It can identify day and night automatically. It is easy to install and used widely.

F 9209 Detector de movimento por infravermelho passivo (IR). Mede a luz infravermelha que é irradiada pelos objectos existentes no seu campo. Geralmente são utilizados em alarmes de segurança e/ou aplicações de iluminação automática.

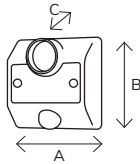

1x
E27

3
YEAR
WARRANTY



MOTION
SENSOR



IP20



360°



50 PCS



Model	SKU	mm	Power	Input	Delay Time	Distance Detect.	Ambient Light	Install. Height	€*
-------	-----	----	-------	-------	------------	------------------	---------------	-----------------	----

Re-
tardo
Atraso

Detec. distancia
Detec. distancia

Luz Ambiente
Luz Ambiente

Altura de instalación
Altura de instalação

A B C *Ecorae incluida | included | incluída * IVA no incluido | VAT not included | IVA não incluído

Model	SKU	A	B	C	Power	Input	Delay Time	Distance Detect.	Ambient Light	Install. Height	€*
FT-9240	F9209	85,5	85,5	38	Max. 60W (E27)	110- 240V, 50/60Hz	Min. 10 sec ± 3sec Max 5min ± 2min	Wall: 6m Max (<24°C) Ceiling: 6m Max (<24°C)	<3-2000lux (Aj/adj)	Wall 1,8-2,5m Ceiling: 2,2-4m	9,24 €



Luminaria de emergencia
Emergency luminaire
Luminária de emergência



LUM.EMERGENCIA | EMERGENCY LUM. | LUM. EMERGÊNCIA

LED EMERGENCY LAMP

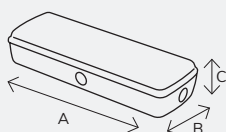

3
YEAR
WARRANTY

LITHIUM
BATTERY

MAINTAINED/
NON MAINTAINED

CRI
80

3H
EMERGENCY
DURATION

5H
FULL CHARGE
TIME

220-240V
50/60HZ

SMD

IP20



Model	Sku	mm			C.Temp	Lumens	IP	Battery	€*
		A	B	C					
FT-7000	F7021	245	100	45	5.000K	100	20	3,7V / 0,8Ah	14,76 €

*Ecorae incluida | included | incluída

* IVA no incluido | VAT not included | IVA não incluído

Accesorios | Accessories | Acessórios

*Ecorae incluida | included | incluída

* IVA no incluido | VAT not included | IVA não incluído



FT-7000/F7023

1,33 €*

Marco de empotrar para IP20
Embedding frame for IP20
Moldura de incorporação para IP20

F7031	PEGATINA "SALIDA"	0,39 €* <hr/>
F7032	PEGATINA "SALIDA EMERGENCIA"	
F7033	PEGATINA "SAÍDA"	
F7034	PEGATINA " SAÍDA EMERGÊNCIA"	
F7035	PEGATINA FLECHA DERECHA/IZQUIERDA	
F7036	PEGATINA FLECHA ARRIBA/BAJO	
F7037	PEGATINA FLECHA DERECHA + PUERTA	
F7038	PEGATINA FLECHA IZQUIERDA + PUERTA	

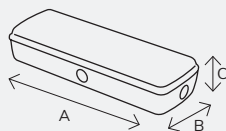

3
YEAR
WARRANTY

**LITHIUM
BATTERY**

**MAINTAINED/
NON MAINTAINED**

CRI
80

3H
EMERGENCY
DURATION

5H
FULL CHARGE
TIME

**220-240V
50/60HZ**

SMD

IP20

AUTOTEST



Model	SKU	mm			C.Temp	Lumens	IP	Battery	€*
		A	B	C					
FT-7000	F7022	245	100	45	5.000K	400	20	3,7V / 2,4Ah	19,23 €

*Ecorae incluida | included | incluída
* IVA no incluido | VAT not included | IVA não incluído

Accesorios | Accessories | Acessórios

*Ecorae incluida | included | incluída
* IVA no incluido | VAT not included | IVA não incluído



FT-7000/F7023 **1,33 €***

Marco de empotrar para IP20
Embedding frame for IP20
Moldura de incorporação para IP20

F7031	PEGATINA "SALIDA"	0,39 €*
F7032	PEGATINA "SALIDA EMERGENCIA"	
F7033	PEGATINA "SAÍDA"	
F7034	PEGATINA " SAÍDA EMERGÊNCIA"	
F7035	PEGATINA FLECHA DERECHA/IZQUIERDA	
F7036	PEGATINA FLECHA ARRIBA/ABAJO	
F7037	PEGATINA FLECHA DERECHA + PUERTA	
F7038	PEGATINA FLECHA IZQUIERDA + PUERTA	

LED EMERGENCY LAMP

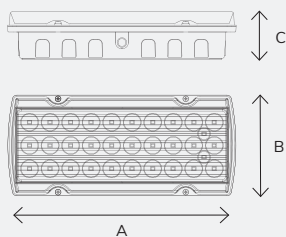

3
YEAR
WARRANTY

LITHIUM
BATTERY

MAINTAINED/
NON MAINTAINED

CRI
80

3H
EMERGENCY
DURATION

5H
FULL CHARGE
TIME

220-240V
50/60HZ

SMD

IP65

AUTOTEST



Model	SKU	mm			C.Temp	Lumens	IP	Battery	€*
		A	B	C					
FT-7000	F7024	250	110	52,5	5.000K	400	65	3,7V / 2,4Ah	19,49 €

*Ecoraee incluída | included | incluída
* IVA no incluido | VAT not included | IVA não incluído

Accesorios | Accessories | Acessórios

*Ecoraee incluída | included | incluída
* IVA no incluido | VAT not included | IVA não incluído

F7031	PEGATINA "SALIDA"	0,39 €*
F7032	PEGATINA "SALIDA EMERGENCIA"	
F7033	PEGATINA "SAÍDA"	
F7034	PEGATINA " SAÍDA EMERGÊNCIA"	
F7035	PEGATINA FLECHA DERECHA/IZQUIERDA	
F7036	PEGATINA FLECHA ARRIBA/ABAJO	
F7037	PEGATINA FLECHA DERECHA + PUERTA	
F7038	PEGATINA FLECHA IZQUIERDA + PUERTA	

LED EMERGENCY LAMP

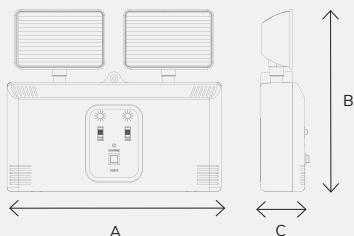

3
YEAR
WARRANTY

AUTOTEST

NON MAINTAINED

CRI
80

IP20

8H
FULL CHARGE
TIME

220-240V
50/60HZ

LITHIUM
BATTERY



Model	SKU	mm			C.Temp	Lumens	IP	Battery	€*
		A	B	C					
FT-7000	F7027	275	234	57	5.000K	DUAL 4.000LM 1,5H	20	14,8V / 3Ah	51,59 €
						SINGLE 2.000LM 3H			

*Ecoraee incluída | included | incluída
* IVA no incluído | VAT not included | IVA não incluído

LED EMERGENCY DOWNLIGHT

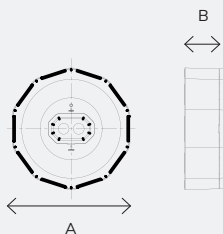

3
YEAR
WARRANTY

AUTOTEST

NON MAINTAINED

CRI
80

3H
EMERGENCY
DURATION

5H
FULL CHARGE
TIME

220-240V
50/60HZ



LITHIUM
BATTERY

IP20

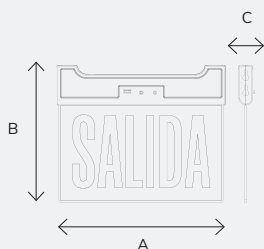

Model	SKU	mm	C.Temp	Lumens	IP	Battery	€*	
		A	B					
		*Ecoraee incluida included incluída * IVA no incluido VAT not included IVA não incluído						
FT-7000	F7025	Ø 145 / Ø 140	48	5.000K	200	20	3,7V / 1,5Ah	33,11 €

LED EMERGENCY DOWNLIGHT



3
YEAR
WARRANTY

MAINTAINED/
NON MAINTAINED

CRI
80

3H
EMERGENCY
DURATION

3H
FULL CHARGE
TIME

220-240V
50/60HZ

LITHIUM
BATTERY

IP20



Model	SKU	mm			C.Temp	Lumens	IP	Battery	€*
		A	B	C					
FT-7000	F7026	245	200	20	6.500K	AC 24LM DC 29LM	20	3,7V / 0,5Ah	16,02 €

*Ecoraee incluida | included | incluída
* IVA no incluido | VAT not included | IVA não incluído

Accesorios | Accessories | Acessórios

*Ecoraee incluida | included | incluída
* IVA no incluido | VAT not included | IVA não incluído

F7031	PEGATINA "SALIDA"	0,39 €*
F7032	PEGATINA "SALIDA EMERGENCIA"	
F7033	PEGATINA "SAÍDA"	
F7034	PEGATINA " SAÍDA EMERGÊNCIA"	
F7035	PEGATINA FLECHA DERECHA/IZQUIERDA	
F7036	PEGATINA FLECHA ARRIBA/ABAJO	
F7037	PEGATINA FLECHA DERECHA + PUERTA	
F7038	PEGATINA FLECHA IZQUIERDA + PUERTA	

EMERGENCY KIT AC 30W

To UFO Meanwell

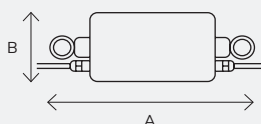

Interruptor de prueba e indicador de carga
Test switch and charge indicator
Interruptor de teste e indicador de carga

Compatible con F6018
Compatible with F6019
Compatível com F6020
F6021

3
YEAR
WARRANTY

AUTOTEST

0° | +50°

IP65

3H
EMERGENCY
DURATION

36H
FULL CHARGE
TIME

100-240V
50/60HZ

**LITHIUM
BATTERY**

Model	Sku	mm		kg	Power	IP	Output	€*
		A	B					
FT-6000	F6031	280	100	2,62	30W	65	230V	247,01 €

*Ecoraee incluída | included | incluída
* IVA no incluído | VAT not included | IVA não incluído

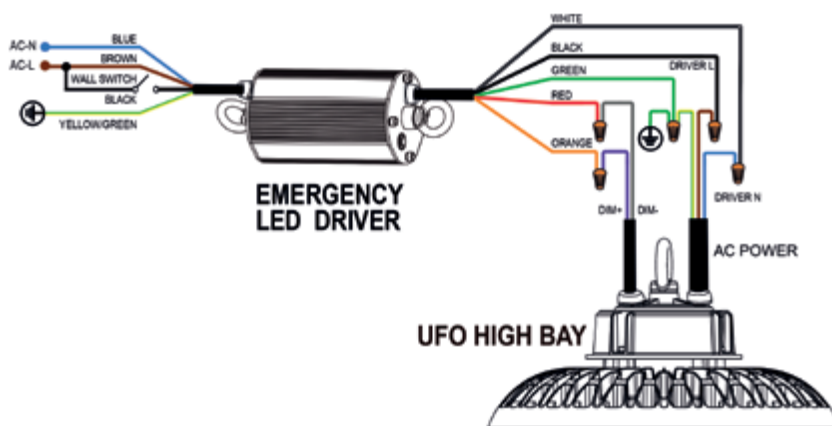

EMERGENCY KIT AC 20W

To UFO Philips



3
YEAR
WARRANTY

AUTOTEST

0° | +50°

IP65

Compatible con
Compatible with
Compatível com

F6043
F6044
F6045
F6070
F6071
F6072
F6073

3H
EMERGENCY
DURATION

24H
FULL CHARGE
TIME

220-240V
50/60HZ

**LITHIUM
BATTERY**

Model	Sku	Power	IP	Output	€*
FT-6000	F6053	20W	65	120-200VDC 250V MAX	246,04 €

*Ecoraee incluída | included | incluida

* IVA no incluído | VAT not included | IVA não incluído

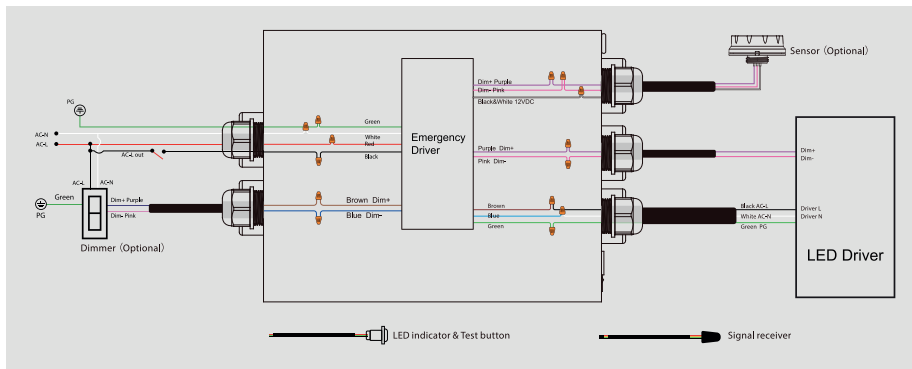

EMERGENCY KIT AC OUT



Conexión directa a cualquier luminaria/tubo/lámpara
 Direct connection to any luminaire/tube/lamp
 Conexão direta a qualquer luminária/tubo/lâmpada

No conectar luminarias de mayor potencia a la potencia máxima de la emergencia
 Do not connect higher power luminaires to the maximum power of the emergency
 Não conecte luminárias de maior potência à potência máxima da emergência



3
YEAR
WARRANTY

AUTOTEST

0° | +50°

IP20

1H
EMERGENCY
DURATION

24H
FULL CHARGE
TIME

100-240V
50/60HZ

**LITHIUM
BATTERY**

Model	Sku	mm			Power	Input	Output	IP	€*
		A	B	C					
FT-7000	F7028	149	40	28	10W	230V	280V	20	80,60 €
	F7029	168	38	28	8-36W				104,90 €
	F7030	122	78	32	30-50W				195,92 €

*Ecorae incluida | included | incluída
 * IVA no incluído | VAT not included | IVA não incluído

DIAGRAMA DE CONEXIONES

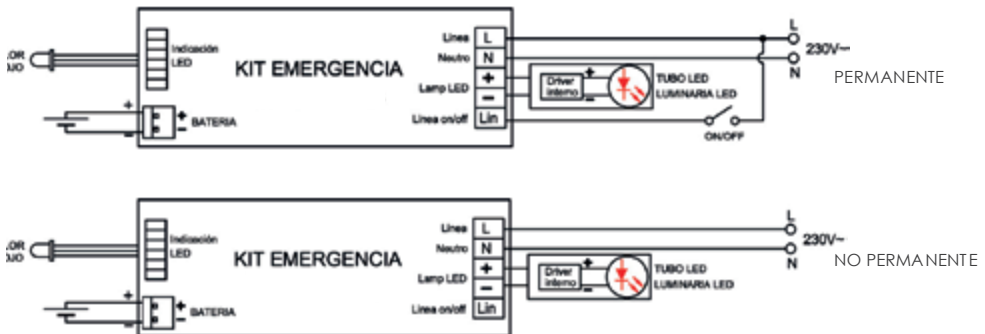

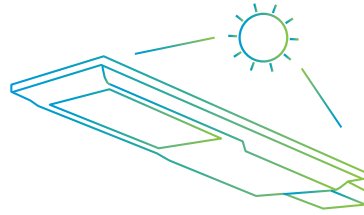

Luminaria solar
Solar luminaire
Luminária solar



LUM. SOLAR | SOLAR LUM. | LUM. SOLAR

SOLAR STREETLIGHT PRO

La farola solar LED Pro es una unidad de luz de sensor compacta. Ideal para utilizar en iluminación vial y urbana, incorpora una batería que hace que su funcionamiento sea autónomo.

The Solar LED Streetlight Pro is a compact sensor light unit. Ideal for use in street and urban lighting, it incorporates a battery that makes it self-contained for autonomous operation.

O candeeiro de rua Solar LED Pro é uma unidade compacta unidade de luz de sensor compacta. Ideal para para utilização em iluminação pública e urbana, incorpora uma bateria que a torna autónoma para um funcionamento autónomo.



5
YEAR
WARRANTY

POWERED
BY THE SUN

TURNS ON
AT DUSK

LITHIUM
BATTERY

145°X100°

CRI
>80

IP65

MOTION
SENSOR

SMD



Sku	Family	mm			kg	Color	C.Temp	Lumens	Solar Panel	Distance	Battery	€*
		A	B	C								
F5278	FT-5002	887	400	275	11	Gray	4.000K	6.500	66W/18V	6-8 m	3,2V/155AH	370,03 €

*Ecoraee incluida | included | incluída
* IVA no incluido | VAT not included | IVA não incluído



Multi-cascade MPPT
charging controller

Capacity **>85%**
after 2000 cycles

Unit cell 3.2V/155AH
blade[®] 496Wh
Less failures than regular batteries

- BLADE[®] system, technologically the most advanced on the market.
- Single module reduces the level of failures than composite batteries
- Eases installation and shipping in case of replacement after the warranty period.

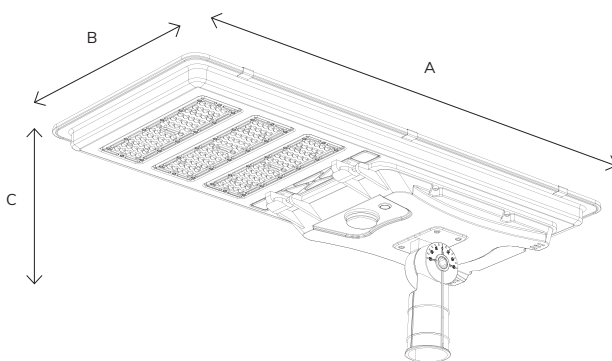

SOLAR LED PRO STREETLIGHT

La farola solar LED Pro es una unidad de luz de sensor compacta. Ideal para utilizar en iluminación vial y urbana, incorpora una batería que hace que su funcionamiento sea autónomo

The Solar LED Streetlight Pro is a compact sensor light unit. Ideal for use in street and urban lighting, it incorporates a battery that makes it self-contained for autonomous operation.

O candeeiro de rua Solar LED Pro é uma unidade compacta unidade de luz de sensor compacta. Ideal para para utilização em iluminação pública e urbana, incorpora uma bateria que a torna autónoma para um funcionamento autónomo.



3
YEAR
WARRANTY

POWERED
BY THE SUN

TURNS ON
AT DUSK

LITHIUM
BATTERY

75° X 135°

CRI
>70

IP65

MOTION
SENSOR

5-6H
FULL CHARGE
TIME

4 PCS



SMD



SKU	Family	mm			kg	Color	C.Temp	Lumens	Solar Panel	Distance	Battery	€*
		A	B	C								
F5277	FT-5002	752	266	45	4,36	Gray	4.000K	4200	5V/30W	6-8 m	3,2V/30AH	167,45 €

*Ecoraee incluida | included | incluída

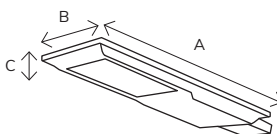
* IVA no incluido | VAT not included | IVA não incluido



SOLAR LED PRO FLOODLIGHTS

El Foco Proyector LED Solar dispone de control remoto y no necesita estar conectado a la red eléctrica para funcionar. Cuenta con un panel solar incorporado que carga su batería ideal para ahorrar en energía o para ser instalado en zonas exteriores remotas para iluminar de forma autónoma.

The Solar LED Floodlight is remote controlled and does not need to be connected to the mains to operate. It has a built-in solar panel that charges its battery ideal for saving energy or to be installed in remote outdoor areas to illuminate autonomously.

O projetor solar LED é controlado à distância e não necessita de estar ligado à rede eléctrica para funcionar. Tem um painel solar incorporado que carrega a bateria, ideal para poupar energia ou para ser instalado em áreas exteriores remotas para iluminar de forma autónoma.



3
YEAR
WARRANTY

POWERED BY THE SUN

TURNS ON AT DUSK

LITHIUM BATTERY

110°

CRI 80

IP65

7H FULL CHARGE TIME

F5274 5 PCS

F5276 3 PCS

SMD



SKU	Family	Floodlights mm			Solar Panel mm			C.Temp	Lumens	Solar Panel	Distance	Battery	€*
		A	B	C	A	B	C						
F5274	FT-5003	200	200	60,4	240	350	17	4.000K	2000	5V / 13W	6 m	3,2V / 12AH	115,36 €
F5276	FT-5003	300	300	63,5	350	500	17	4.000K	4800	15V / 32W	6 m	9,6V / 12AH	194,26 €

*Ecoraee incluida | included | incluída
* IVA no incluido | VAT not included | IVA não incluído

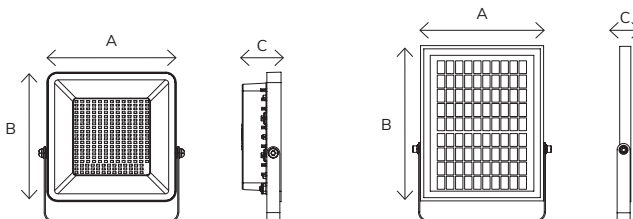

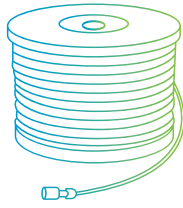

Tiras
Strips
Fitas



TIRA LED AC 230V

La bobina de tira LED AC 230V Filux ofrece una iluminación de calidad con muy bajo consumo energético. Permite crear ambientes especiales, personalizar espacios y darles un toque diferenciador.

The Filux AC 230V LED Strip coil offers quality lighting with very low power consumption. It allows to create special environments, to personalize spaces and to give them a differentiating style.

O rolo de da fita de LED AC 230V Filux oferece uma iluminação e qualidade com baixo consumo de energia. Permite criar ambientes especiais, personalizar espaços e dar-lhes um toque diferenciador.



3
YEAR
WARRANTY

CRI
>80

120°

10CM
CUTTABLE

Model	SKU	mm/PCB	Power	Input	IP	Led Quantity	C.Temp	Size	€*
Cantidad de led Quantidade									
*Ecoraee incluida included incluída * IVA no incluido VAT not included IVA não incluido									
FT-2919	F2950	10	19W/M 100LM/W	AC 230V	IP65	120LEDs/m	2.700K	1 meter	10,70 €
	F2950-50							50 meters	510,80 €
	F2951						4.000K	1 meter	10,70 €
	F2951-50							50 meters	510,80 €
	F2952						6.000K	1 meter	10,70 €
	F2952-50							50 meters	510,80 €
FT2912	F2953	8	12W/M 90LM/W	AC 230V	IP65	120LEDs/m	2.700K	1 meter	7,20 €
	F2953-50							50 meters	343,71 €
	F2954						4.000K	1 meter	7,20 €
	F2954-50							50 meters	343,71 €
	F2955						6.000K	1 meter	7,20 €
	F2955-50							50 meters	343,71 €

TIRA LED AC 230V COB

La bobina de tira LED COB 24V Filux ofrece una iluminación de calidad con muy bajo consumo energético. Permite crear ambientes especiales, personalizar espacios y darles un toque diferenciador.

The Filux COB 24V LED Strip coil offers quality lighting with very low power consumption. It allows to create special environments, to personalize spaces and to give them a differentiating style.

O rolo de da fita de LED COB 24V Filux oferece uma iluminação e qualidade com baixo consumo de energia. Permite criar ambientes especiais, personalizar espaços e dar-lhes um toque diferenciador.



3
YEAR
WARRANTY

CRI
>80

120°

10CM
CUTTABLE *Except RGB 50cm

Model	Sku	mm/PCB	Power	Input	IP	Led Quantity	C.Temp	Size	€*
Cantidad de led Quantidade de led									
*Ecoraee incluida included incluída * IVA no incluido VAT not included IVA não incluído									
FT-2916	F2956	8	16W/m 85LM/W	AC 230V	IP65	560 CHIPS	2.200K	1 meter	14,16 €
	F2956-50							50 meters	675,77 €
	F2957						2.700K	1 meter	14,16 €
	F2957-50							50 meters	675,77 €
	F2958						4.000K	1 meter	14,16 €
	F2958-50							50 meters	675,77 €
	F2959						6.000K	1 meter	14,16 €
	F2959-50							50 meters	675,77 €
	F2960						18W	420 CHIPS	RGB
	F2960-50*		50 meters			699,04 €			

TIRA LED SMD 2835 24V

La bobina de tira LED SMD 2835 24V Filux ofrece una iluminación de calidad con muy bajo consumo energético. Permite crear ambientes especiales, personalizar espacios y darles un toque diferenciador.

The Filux SMD 2835 24V LED Strip coil offers quality lighting with very low power consumption. It allows to create special environments, to personalize spaces and to give them a differentiating style.

O rolo de da fita de LED SMD 2835 24V Filux oferece uma iluminação e qualidade com baixo consumo de energia. Permite criar ambientes especiais, personalizar espaços e dar-lhes um toque diferenciador.



5
YEAR
WARRANTY

CRI
>80

120°

100LM/W

SINGLE LED
CUTTABLE

Model	SKU	mm/PCB	Power	Input	IP	Led Quantity	C.Temp	Size	€*
Cantidad de led Quantidade de led									
*Ecorae incluida included incluída * IVA no incluido VAT not included IVA não incluído									
FT-2912	F2930	8	12W/m	DC24V	IP20	2.200K		1 meter	5,62 €
	F2930-5							5 meters	27,63 €
	F2930-50							50 meters	271,88 €
	F2931							1 meter	5,62 €
	F2931-5							5 meters	27,63 €
	F2931-50							50 meters	271,88 €
	F2932					1 meter	5,62 €		
	F2932-5					5 meters	27,63 €		
	F2932-50					50 meters	271,88 €		
	F2933					1 meter	5,62 €		
	F2933-5					5 meters	27,63 €		
	F2933-50					50 meters	271,88 €		
	F2934				1 meter	7,00 €			
	F2934-5				5 meters	34,22 €			
	F2934-50				50 meters	334,60 €			
	F2935				1 meter	7,00 €			
	F2935-5				5 meters	34,22 €			
	F2935-50				50 meters	334,60 €			
	F2936				1 meter	7,00 €			
	F2936-5				5 meters	34,22 €			
	F2936-50				50 meters	334,60 €			
	F2937				1 meter	7,00 €			
	F2937-5				5 meters	34,22 €			
	F2937-50				50 meters	334,60 €			

TIRA LED COB 24V

La bobina de tira LED COB 24V Filux ofrece una iluminación de calidad con muy bajo consumo energético. Permite crear ambientes especiales, personalizar espacios y darles un toque diferenciador.

The Filux COB 24V LED Strip coil offers quality lighting with very low power consumption. It allows to create special environments, to personalize spaces and to give them a differentiating style.

O rolo de da fita de LED COB 24V Filux oferece uma iluminação e qualidade com baixo consumo de energia. Permite criar ambientes especiais, personalizar espaços e dar-lhes um toque diferenciador.



5
YEAR
WARRANTY

CRI
>90

120°

100LM/W

SCM
CUTTABLE

Model	SKU	mm/PCB	Power	Input	IP	Led Quantity	C.Temp	Size	€*
Cantidad de led Quantidade de led									
*Ecorae incluida included incluída * IVA no incluido VAT not included IVA não incluído									
FT-2912	F2938	8	12W/m	DC24V	IP20	2.200K		1 meter	6,50 €
	F2938-5							5 meters	31,94 €
	F2938-50							50 meters	314,00 €
	F2939							1 meter	6,50 €
	F2939-5							5 meters	31,94 €
	F2939-50							50 meters	314,00 €
	F2940					1 meter	6,50 €		
	F2940-5					5 meters	31,94 €		
	F2940-50					50 meters	314,00 €		
	F2941					1 meter	6,50 €		
	F2941-5					5 meters	31,94 €		
	F2941-50					50 meters	314,00 €		
	F2942				IP67	2.200K		1 meter	8,61 €
	F2942-5							5 meters	42,20 €
	F2942-50							50 meters	413,36 €
	F2943							1 meter	8,61 €
	F2943-5							5 meters	42,20 €
	F2943-50							50 meters	413,36 €
	F2944					4.000K		1 meter	8,61 €
	F2944-5							5 meters	42,20 €
	F2944-50							50 meters	413,36 €
	F2945							1 meter	8,61 €
	F2945-5							5 meters	42,20 €
	F2945-50							50 meters	413,36 €

TIRA LED SMD 24V 3535+2835 RGBW

La bobina de tira LED SMD 2835+2835 RGBW Filux ofrece una iluminación de calidad con muy bajo consumo energético. Permite crear ambientes especiales, personalizar espacios y darles un toque diferenciador.

The Filux SMD 2835+2835 RGBW LED Strip coil offers quality lighting with very low power consumption. It allows to create special environments, to personalize spaces and to give them a differentiating style.

O rolo de da fita de LED SMD 2835+2835 RGBW Filux oferece uma iluminação e qualidade com baixo consumo de energia. Permite criar ambientes especiais, personalizar espaços e dar-lhes um toque diferenciador.



5
YEAR
WARRANTY

CRI
>90
@4000K

120°

100LM/W
@4000K

Model	SKU	mm/PCB	Power	Input	IP	Led Quantity	C.Temp	Size	€*
						Cantidad de led Quantidade de led			
*Ecoraee incluida included incluída * IVA no incluido VAT not included IVA não incluído									
FT-2912	F2946	8	12W/m	DC24V	IP44	60+60LEDs/M	RGB+W(4.000K)	5 meters	47,97 €

24V LED STRIPS POWER SUPPLY

Power supply

Fuente alimentación
Power supply
Fonte de alimentação



5
YEAR
WARRANTY

-10° | +60°

Model	Sku	Power	Input V	Output V	Output Current	Efficiency	mm	IP	€*
-------	-----	-------	---------	----------	----------------	------------	----	----	----

*Ecoraee incluída | included | incluída * IVA no incluído | VAT not included | IVA não incluído

FT-2804	F2865	36W	AC100-240V, 50/60Hz	24V±5%	1.5A	≥85%	135x35x24	20	8,13 €
	F2866	60W			2.5A		170x35x24		11,17 €
	F2867	100W			4.17A		145x49x29		14,68 €
	F2868	150W			6.25A		195x49x29		20,12 €
	F2869	200W			8.3A		195x49x29		21,65 €
	F2895	300W			12.5A		245x62x29		27,95 €
	F2870	60W	AC100-277V, 50/60Hz		2.5A		203x35x25	67	16,23 €
	F2871	100W			4.17A		187x69x19		24,79 €
	F2872	150W			6.25A		187x69x19		30,83 €
	F2873	200W			8.33A		227x80x39		42,11 €

Model	Sku	Model	Reg.	Power	Output V	IP	€*
-------	-----	-------	------	-------	----------	----	----

*Ecoraee incluída | included | incluída * IVA no incluído | VAT not included | IVA não incluído

FT-2804	F2913	GAT	TRIAC	75W	DC24V	20	61,66 €
	F2914	GAT	TRIAC	150W			73,06 €
	F2915	GDE	0-10V	75W			51,14 €
	F2916	GDE	0-10V	150W			65,57 €
	F2917	GAA	0-10V+CCT	150W			74,30 €
	F2918	GSD-B	DALI2+PUSH	75W			55,07 €
	F2919	GSD-B	DALI2+PUSH	150W			70,98 €
	F2920	GSD-A	DALI2+PUSH+CCT	75W			57,44 €
	F2922	GSD-A	DALI2+PUSH+CCT	150W			79,10 €
	F2923	GAD	DALI2+PUSH+0-10+PWM+RX	40W			37,89 €
	F2924	GAD	DALI2+PUSH+0-10+PWM+RX	240W			109,12 €
	F2925	GAB-A	BLUETHOOTH TUYA CCT	150W			77,86 €
	F2926	GAB-A	BLUETHOOTH TUYA CCT DIMMABLE	150W			76,38 €

24V LED STRIPS CONECTORS

Conector IP20

Conector IP20
IP20 Connector
Conector IP20

3
YEAR
WARRANTY

Model	Sku	To	IP	€*		
*Ecoraee incluida included incluída * IVA no incluido VAT not included IVA não incluído						
FT- 2801	F2978	CONECTOR EMPALME DIRECTO	2 PINS	PCB 8MM SMD/COB	20	0,57 €
	F2979	CONECTOR CON 15 CM DE CABLE			0,83 €	
	F2980	CONECTOR EMPALME CON 15 CM DE CABLE			1,39 €	
	F2981	CONECTOR ESQUINA			0,91 €	
	F2982	CONECTOR EMPALME DIRECTO	5 PINS	RGBW PCB 12MM SMD	1,09 €	
	F2983	CONECTOR CON 15 CM DE CABLE			1,61 €	

Conector IP65

Conector IP65
IP65 Connector
Conector IP65

3
YEAR
WARRANTY

Model	Sku	To	IP	€*		
*Ecoraee incluida included incluída * IVA no incluido VAT not included IVA não incluído						
FT-2830	F2963	CONECTOR EMPALME DIRECTO	2 PINS	PCB 8MM	65	1,69 €
	F2964	CONECTOR CON 15 CM DE CABLE			2,43 €	
	F2965	CONECTOR EMPALME CON 15 CM DE CABLE			3,38 €	
	F2966	CONECTOR ESQUINA			2,08 €	
	F2967	TAPA FINAL IP65 2PIN PARA TIRA PCB 8MM			0,22 €	
	F2968	CONECTOR EMPALME DIRECTO			1,69 €	
	F2969	CONECTOR CON 15 CM DE CABLE	4 PINS	PCB 10MM	2,43 €	
	F2970	CONECTOR EMPALME CON 15 CM DE CABLE			3,38 €	
	F2971	CONECTOR ESQUINA			2,08 €	
	F2972	TAPA FINAL IP65 2PIN PARA TIRA PCB 10MM			0,22 €	
	F2973	CONECTOR EMPALME DIRECTO			2,17 €	
	F2974	CONECTOR CON 15 CM DE CABLE			3,25 €	
	F2975	CONECTOR EMPALME CON 15 CM DE CABLE			4,55 €	

Accesorios Conector IP65

F2962	TUBO SOLICONA para sellar conectores SILICONE TUBE to seal connectors TUBO DE SILICONE para vedar conectores	1,18 €* 1,18 €*
F2984	Tapa INICIAL IP65 2PIN para tira PCB 8MM IP65 2PIN INITIAL cap for 8MM PCB strip Tampa INICIAL IP65 2PIN para tira PCB de 8 MM	0,53 €* 0,53 €*
F2985	Tapa FINAL IP65 2PIN para tira PCB 8MM IP65 2PIN ENDcap for 8MM PCB strip Tampa FINAL IP65 2PIN para tira PCB de 8 MM	0,18 €* 0,18 €*
F2986	Tapa INICIAL IP65 2PIN para tira PCB 10MM IP65 2PIN INITIAL cap for 8MM PCB strip Tampa INICIAL IP65 2PIN para tira PCB de 8 MM	0,53 €* 0,53 €*
F2987	Tapa FINAL IP65 2PIN para tira PCB 10MM IP65 2PIN END cap for 8MM PCB strip Tampa FINAL IP65 2PIN para tira PCB de 8 MM	0,18 €* 0,18 €*
F2864	Kit conector flexible atornillado IP65 IP65 Screwed flexible connector Kit Kit de conector flexível aparafusado IP65	2,94 €* 2,94 €*

CONTROLADORES Y SENSORES

Tiras LED 24V

*Ecoraee incluida | included | incluída
* IVA no incluido | VAT not included | IVA não incluído

Controller

Controlador
Controller
Controlador

5
YEAR
WARRANTY

IP20

-30° | +55°



Model	SKU	Power	Input V	Output V	Output Current	mm	€*
*Ecoraee incluida included incluída * IVA no incluido VAT not included IVA não incluído							
FT-2801	F2989	72W/144W	12-24VDC	12-24VDC	1.5A*4CH (RGBW)	114x38x20	15,52 €
	F2878	180-360W		5x12-24VDC	5CH,3A/CH (RGBW)		26,28 €
	F2879	60-120W		12-24VDC	Max. 5A	64X23,5X8,5	10,63 €
	F2880	72-144W	12-48VDC	12-48VDC	8A@12/24V,4A36/48V	52x52x26	22,22 €
	F2881	240-480W	12-24VDC	12-24VDC	1CH,20A	107x75x24,5	27,13 €
	F2882				1CH,20A Max.	107x75x38	28,30 €

Power repeater

Repetidor potencia 8A
Power Repeater 8A
Repetidor energia 8A

192W



5
YEAR
WARRANTY

IP20

-30° | +55°

FT-2801 F2883	Input voltage	5-36VDC	13,00 €*
	Input current	8.5A	
	Input signal	PWM	
	Output voltage	5-36VDC	
	Output current	8A	
	Output power	40-288W	
	Output type	Constant voltage	

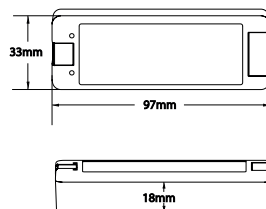

*Ecoraee incluida | included | incluída
 * IVA no incluido | VAT not included | IVA não incluído

ON/OFF sensor + dimmer

Sensor ON/OFF + dimmer
 ON / OFF sensor + dimmer
 Sensor ON / OFF + dimmer

75W



FT-2801 F2884	Input voltage	12-24VDC
	Output voltage	12-24VDC
	Output power	Max. 36W@12V Max. 72W@24V
	Output type	Constant voltage

8,08 €*

5
YEAR
WARRANTY

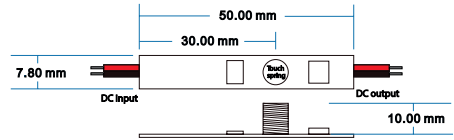
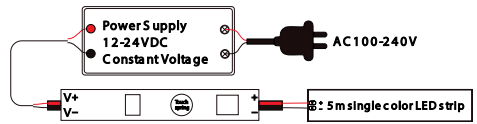

Door sensor

Sensor de puerta
 Door sensor
 Sensor da porta

96W



FT-2801 F2885	Input voltage	12-24VDC
	Output voltage	12-24VDC
	Output power	Max. 48W@12V Max. 96W@24V
	Detect. distance	<10 cm
	Detect. angle	15-30

9,29 €*

5
YEAR
WARRANTY

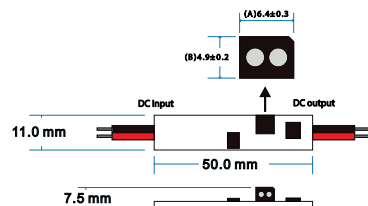
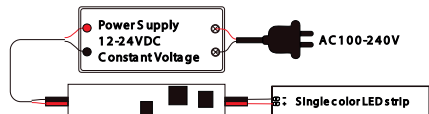

CONTROLADORES Y SENSORES

Tiras LED DC24V

*Ecoraee incluida | included | incluída
* IVA no incluido | VAT not included | IVA não incluído

Motion sensor

Sensor de movimiento
Motion sensor
Sensor de movimento

72W



5
YEAR
WARRANTY

-30° | +55°

FT-2801 F2886	Input voltage	12-24VDC	10,78 €*
	Output voltage	12-24VDC	
	Output power	Max. 36W@12V Max. 72W@24V	
	Detect. distance	<3m	
	Detect. angle	120	

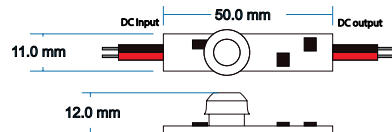
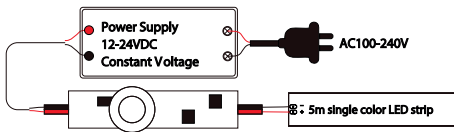

Microwave sensor

Microwave sensor
Microwave sensor
Microwave sensor



5
YEAR
WARRANTY

IP20

-30° | +55°

FT-2801 F2887	Working voltage	9-24VDC	24,39 €*
	Output signal	RF 2.4GHz	
	HF system	10.525GHz	
	Power consumption	< 0.5W(Standby) , <1W(Operation)	
	Detection zone	Max.(DxH) 20 x 15m	
	Detection sensitivity	10%/25%/50%/75%/100%	
	Hold time	10S/30S/90S/3MIN/10MIN/20MIN/30MIN	
	Daylight sensor	50lux/100lux/150lux/200lux/250lux/300lux/400lux	
	Mounting height	15M MAX.	
	Motion detection	0.5-3M/S	
	Detection angle	150° Wall 360° Ceiling	

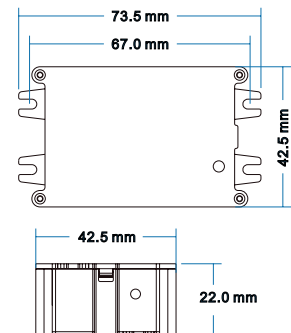

CONTROLADORES

AC 220V

*Ecorae incluida | included | incluída
* IVA no incluido | VAT not included | IVA não incluído

AC triac wireless regulator pickup

5
YEAR
WARRANTY

IP20

-30° | +55°

Pastilla regulador inalámbrico AC TRIAC
AC TRIAC Wireless Regulator Pickup
Pastilha regulador TRIAC AC sem fio

FT-2801 F2893	Input voltage	AC100-240V	30,27 €*
	Output voltage	AC100-240V	
	Output current	Max 1,5A	
	Output power	150-360W	
	Input signal	RF 2.4GHz+Push Dim	
	RF Cont. distance	30m	



FT-2801 F2988	Input voltage	AC100-240V	34,67 €*
	Output voltage	AC100-240V	
	Output current	Max 2A	
	Output power	200-480W	
	Input signal	RF 2.4GHz+Push Dim	
	RF Cont. distance	30m	



F2976	CONTROLADOR S3(WT) PARA RGB COB 220V TUYA WIFI + RF 2.4GHz + PUSH DIM	61,28 €*
F2892	PASTILLA SS-L(WT)INTERRUPTOR INALAMBICO AC220V ON/OFF TUYA 15A	36,32 €*
F2990	REDUCTOR FLICKER 250W PARA TIRA LED AC 230 SMD	37,72 €*
F2991	REDUCTOR FLICKER 250W PARA TIRA LED AC 230 COB	37,72 €*

MANDOS RF

DC24V Y AC 220V

*Ecoraee incluida | included | incluída
 * IVA no incluido | VAT not included | IVA não incluído

RF remote control

Mando RF 4 zonas
 RF remote control 4 zones
 Controle remoto RF 4 zonas

5
 YEAR
 WARRANTY

IP20

-30° | +55°

FT-2801 F2888 RT6 MONOCOLOR	Output signal	RF(2.4GHz)	27,63 €*
	Working voltage	3VDC(AAAx2)	
	Working current	<5mA	
	Standby current	<10µA	
	Standby time	1 year	
	Remote distance	30m	



FT-2830 F2977 RT9 GRB/W	Output signal	RF(2.4GHz)	30,43 €*
	Working voltage	3VDC(AAAx2)	
	Working current	<5mA	
	Standby current	<10µA	
	Standby time	1 year	
	Remote distance	30m	



RH single-color remote control

Mando monocolor RF 1 zona
 RF single-color remote control 1 zone
 Controle remoto RF com uma cor 1 core

5
 YEAR
 WARRANTY

IP20

-30° | +55°

FT-2801 F2889	Output signal	RF(2.4GHz)	13,38 €*
	Working voltage	3VDC(AAAx2)	
	Working current	<5mA	
	Standby current	<2µA	
	Standby time	2 years	
	Remote distance	30m	

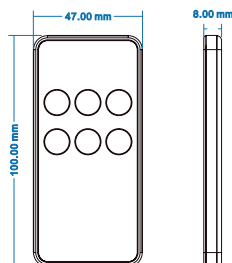

*Ecoraee incluida | included | incluída
 * IVA no incluido | VAT not included | IVA não incluido

RH wireless push button

Pulsador inalámbrico RF 1 zona
 RF wireless push button 1 zone
 Botão sem fio RF de 1 zona



5
YEAR
WARRANTY

IP20

-30° | +55°

FT-2801 F2890	Output signal	RF(2.4GHz)	18,87 €*
	Working voltage	3VDC(CR2032)	
	Working current	<5mA	
	Standby current	<2µA	
	Standby time	2 years	
	Remote distance	30m	

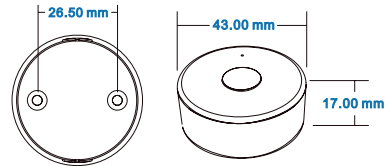

Central wifi

Central WIFI
 Central WIFI
 Central Wi-Fi



5
YEAR
WARRANTY

IP20

-30° | +55°

FT-2801 F2894	Operating V & Current:	DC5-24V,300mA	54,53 €*
	Wireless standard:	802.11 b/g/n	
	Frequency range	2.412GHz~2.484GHz	
	Remote Distance:	30m	
	Standby time	2 years	
	Remote distance	30m	

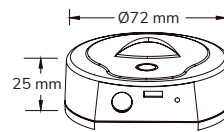

ALUMINIUM PROFILES

*Ecorae incluida | included | incluida * IVA no incluido | VAT not included | IVA não incluído



FT-2802	F2901	Perfil aluminio 2M Aluminio superficie Aluminum profile 2M Aluminum surface Perfil de alumínio 2M superfície Alumínio	●	7,75 €*
	F2902	Perfil aluminio 2M Blanco superficie Aluminum profile 2M White surface Perfil de alumínio 2M superfície Branca	○	7,96 €
	F2903	Perfil aluminio 2M Negro superficie Aluminum profile 2M Black surface Perfil de alumínio 2M superfície Petra	●	8,61 €



FT-2802	F2904	Perfil aluminio 2M Aluminio empotrar Aluminum profile 2M Aluminum recessed Perfil de alumínio 2M encastrar Alumínio	●	8,31 €
	F2905	Perfil aluminio 2M Blanco empotrar Aluminum profile 2M White recessed Perfil de alumínio 2M encastrar Branca	○	8,61 €
	F2906	Perfil aluminio 2M Negro superficie Aluminum profile 2M Black recessed Perfil de alumínio 2M encastrar Petra	●	9,26 €

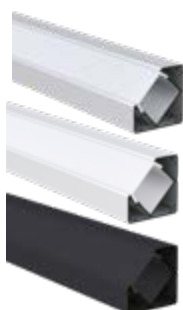

FT-2802	F2907	Perfil aluminio 2M Aluminio ángulo Aluminum profile 2M Aluminum angle Perfil de alumínio 2M ângulo Alumínio	●	7,75 €
	F2908	Perfil aluminio 2M Blanco ángulo Aluminum profile 2M White angle Perfil de alumínio 2M ângulo Branca	○	8,31 €
	F2909	Perfil aluminio 2M Negro ángulo Aluminum profile 2M Black angle Perfil de alumínio 2M ângulo Petra	●	8,92 €

FT-2802	F2910	Pletina aluminio 1M para tira LED 1M aluminum plate for LED strip Placa de alumínio 1M para fita LED	●	1,71 €
	F2911	Rollo 10M funda Milky Rol 10M Milky cover Rolo 10M cobertura Milky	○	6,91 €
	F2912	Rollo 10M funda Negra Rol 10M Black cover Rolo 10M de cobertura Petra	●	7,99 €



Bombillas

Bulbs

Lâmpadas

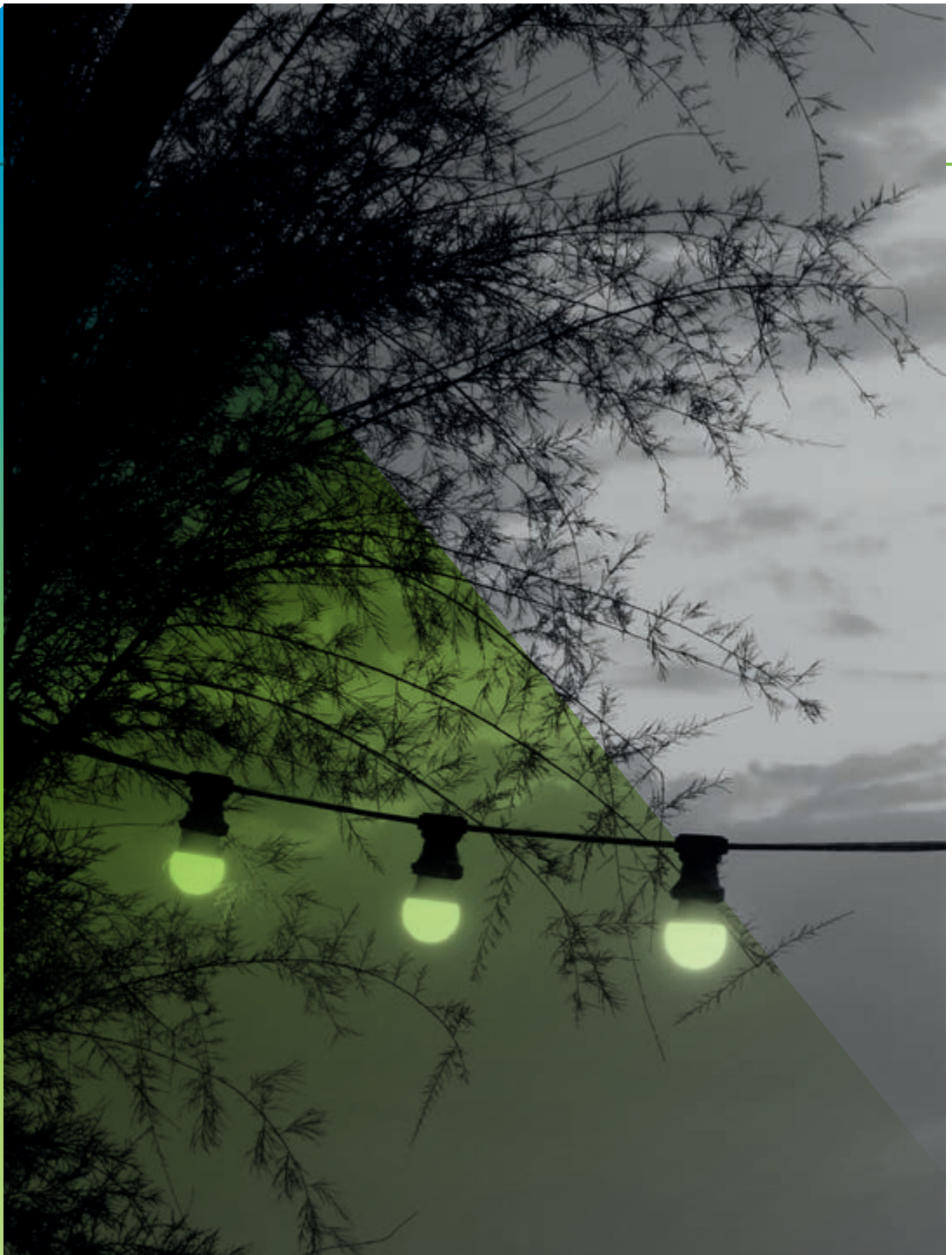

GU10 LED BULB

Esta bombilla LED de Filux con conexión GU10 nos proporciona un agradable tono de luz. Supone una alternativa muy buena con amplias posibilidades de decoración y gran ahorro energético. Su instalación es muy sencilla, basta con retirar el halógeno tradicional y situar la nueva lámpara con casquillo GU10 con conexión directa a la red.

This Filux LED bulb with GU10 connection provides a pleasant light tone. That means a very good alternative with ample possibilities of decoration and great energy saving. Its installation is very simple, just remove the traditional halogen and place the new lamp with GU10 bushing with direct connection to the network.

Esta lâmpada LED Filux com ligação GU10 fornece um tom de luz bastante agradável. É uma alternativa com amplias possibilidades de decoração e grande poupança energética. Sua instalação é muito simples, basta remover a lâmpada de halogéneo tradicional e colocar a nova lâmpada GU10 com ligação direta à rede.

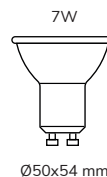

3
YEAR
WARRANTY

15.000H

CRI
>80

110°

IP20

GU10

100PCS

SMD



Model	SKU	Power	C.Temp	Lumens	Input	€*
FT-1507	F1523	7W	3.000K	700 lm	220-240V, 50Hz	1,78 €
	F1524		4.000K			
	F1525		6.500K			

*Ecoraee incluída | included | incluída * IVA no incluído | VAT not included | IVA não incluído

GU10 CRISTAL DIMMABLE LED BULB

La bombilla LED GU10 de Filux con conexión GU10 nos proporciona un agradable tono de luz regulable. Supone un gran ahorro energético. Su instalación es muy sencilla, basta con retirar el halógeno tradicional y situar la nueva lámpara con casquillo GU10 con conexión directa a la red.

This Filux LED bulb with GU10 connection provides a pleasant light tone. That means a very good alternative with ample possibilities of decoration and great energy saving. Its installation is very simple, just remove the traditional halogen and place the new lamp with GU10 bushing with direct connection to the network.

A lâmpada LED Filux PRO Cristal com ligação GU10 proporciona-nos um agradável tom de luz ajustável. Representa grande economia de energia. A sua instalação é muito simples, bastando retirar o halógeno tradicional e colocar a nova lâmpada com casquilho GU10 com ligação direta à rede.

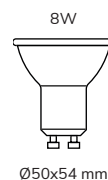

5
YEAR
WARRANTY

25.000H

CRI
>97

60°

TRIAC
DIMMABLE

IP20

GU10

100 PCS



Model	SKU	Power	C.Temp	Lumens	Input	€*
FT-1505	F1526	8W	2.700K	720 lm	220-240V, 50Hz	6,70 €
	F1527		4.000K	800 lm		
	F1528		5.700K			

*Ecoraee incluída | included | incluída * IVA no incluído | VAT not included | IVA não incluído

GU10 LENTE 100° DIMMABLE LED BULB

La bombilla LED GU10 de Filux con conexión GU10 nos proporciona un agradable tono de luz regulable. Supone un gran ahorro energético. Su instalación es muy sencilla, basta con retirar el halógeno tradicional y situar la nueva lámpara con casquillo GU10 con conexión directa a la red.

This Filux LED bulb with GU10 connection provides a pleasant light tone. That means a very good alternative with ample possibilities of decoration and great energy saving. Its installation is very simple, just remove the traditional halogen and place the new lamp with GU10 bushing with direct connection to the network.

A lâmpada LED Filux PRO Cristal com ligação GU10 proporciona-nos um agradável tom de luz ajustável. Representa grande economia de energia. A sua instalação é muito simples, bastando retirar o halógeno tradicional e colocar a nova lâmpada com casquilho GU10 com ligação direta à rede.

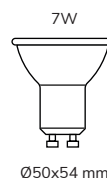

3
YEAR
WARRANTY

25.000H

CRI
>80

100°

TRIAC
DIMMABLE

IP20

GU10

200 PCS

SMD



Model	SKU	Power	C.Temp	Lumens	Input	€*
FT-1507	F1529	7W	3.000K	630	220-240V, 50Hz	2,73 €
	F1530		4.000K			
	F1531		6.500K			

*Ecoraee incluída | included | incluída * IVA no incluido | VAT not included | IVA não incluído

A60 LED BULB

Bombilla LED A60 E27 de Filux con una alta eficiencia energética y una vida útil de larga duración. Es ideal para sustituir a las antiguas bombillas de incandescencia con casquillo E27, consiguiendo un ahorro energético del 80%. Ofrece un encendido instantáneo y es respetuosa con el medio ambiente.

Filux LED bulb A60 E27 with high energy efficiency and long life. It's ideal for replacing old incandescent bulbs with a E27 socket, achieving an 80% energy saving. It offers an instant start and is respectful with the environment.

As lâmpadas LED Filux A60 E27 de alta eficiência energética e vida longa. São ideais para substituir as lâmpadas incandescentes E27, permitindo uma economia de energia de 80%. Dispõem de acendimento instantânea e respeitam o meio ambiente.



7W / 8W / 11W



Ø60x112 mm

13,7W



Ø60x120mm

3
YEAR
WARRANTY

15.000H

220°

CRI
>80



IP20



E27



SMD



100 PCS



Model	SKU	Power	C.Temp	Lumens	Input	€*
-------	-----	-------	--------	--------	-------	----

*Ecoraee incluída | included | incluída * IVA no incluído | VAT not included | IVA não incluído

FT-1605	F1601	5W	3.000K	470	220-240V, 50Hz	1,39 €
	F1602		4.000K			
	F1603		6.500K			
FT-1610	F1633	8W	3.000K	840		1,72 €
	F1634		4.000K			
	F1635		6.500K			
FT-1612	F1636	11W	3.000K	1.100		2,00 €
	F1637		4.000K			
	F1638		6.500K			
FT-1616	F1639	13,7W	3.000K	1.600		2,42 €
	F1640		4.000K			
	F1641		6.500K			

A55 LED BULB

Bombilla LED A55 E27 de Filux con una alta eficiencia energética y una vida útil de larga duración. Es ideal para sustituir a las antiguas bombillas de incandescencia con casquillo E27, consiguiendo un ahorro energético del 80%. Ofrece un encendido instantáneo y es respetuosa con el medio ambiente.

Filux LED bulb A55 E27 with high energy efficiency and long life. It's ideal for replacing old incandescent bulbs with a E27 socket, achieving an 80% energy saving. It offers an instant start and is respectful with the environment.

Lâmpada LED A55 E27 Filux, de alta eficiência energética e vida útil longa. É ideal para a substituição das lâmpadas antigas de incandescência, permitindo uma poupança de energia até 80%. É de acendimento instantâneo e respeita o meio ambiente.



3
YEAR
WARRANTY

200°

25.000H

E27

CRI
>80

SMD

IP20

100 PCS



Model	SKU	Power	C.Temp	Lumens	Input	€*
FT-1505	F1511	5W	3.000K	400	220-240V, 50Hz	1,39 €
	F1512		4.000K			
	F1510		6.500K			

*Ecoraee incluída | included | incluída
* IVA no incluido | VAT not included | IVA não incluído

R90 LED BULB 15W

La Bombilla LED FT-3515 sustituye a las lámparas incandescentes tradicionales de hasta 100W con casquillo E27. Su carcasa translúcida tiene una forma característica. Proporcionan un agradable tono de luz además de un ahorro en el consumo superior al 80%.

The FT-3515 LED Bulb replaces traditional incandescent lamps up to 100W with E27 lamp holder. It's translucent shell has a characteristic shape. They provide a pleasant tone of light in addition to a saving in consumption of more than 80%.

A lâmpada LED FT-3515 substitui as lâmpadas incandescentes tradicionais até R90 E27 de 100W. O seu corpo é translúcido têm uma forma característica. Fornecem um tom de luz muito agradável de luz, além permitir poupanças de energia até 80%.

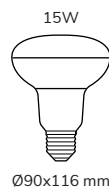

3
YEAR
WARRANTY

120°

25.000H

E27

CRI
>80

SMD

IP20

50 PCS



Model	SKU	Power	C.Temp	Lumens	Input	€*
*Ecoraee incluida included incluída * IVA no incluido VAT not included IVA não incluído						
FT-3515	F1623	15W	3.000K	1.300	175-250V, 50HZ	4,33 €
	F1624		4.000K			
	F1625		6.000K			

G45 LED BULB 7W

Bombilla Esférica LED G45 E27 con LEDs Osram de Filux ideales para uso doméstico. Perfectas para todo tipo de aplicaciones, gracias a los múltiples tamaños y prestaciones. Obtendrás mayor eficiencia y ahorro en tu factura de la electricidad, al mismo tiempo que disfrutarás de iluminación de mayor calidad.

Filux LED Light Bulb G45 E27 with Osram LEDs ideal for home use. Perfect for all types of applications, thanks to the multiple sizes and features. You will get more efficiency and savings in your electricity bill, while enjoying better lighting.

Lâmpada esférica LED G45 E27 Filux com Chip Osram, ideal para uso doméstico. Indicada para todos os tipos de aplicação, graças aos vários tamanhos e potências. Permite maior otimização na conta de electricidade enquanto beneficia de uma iluminação de melhor qualidade.



3
YEAR
WARRANTY

15.000H

CRI
>80

220°

IP20

E27

100 PCS



Model	SKU	Power	C.Temp	Lumens	Input	€*
*Ecoraee incluida included incluída * IVA no incluido VAT not included IVA não incluído						
FT-1807	F1810	7W	3.000K	700 lm	220-240V, 50Hz	1.64 €
	F1811		4.000K			
	F1812		6.500K			

P45 LED BULB

Bombilla Esférica LED P45 E14 de Filux ideales para uso doméstico. Perfectas para todo tipo de aplicaciones, gracias a los múltiples tamaños y prestaciones. Obtendrás mayor eficiencia y ahorro en tu factura de la electricidad, al mismo tiempo que disfrutarás de iluminación de mayor calidad.

Filux LED Light Bulb P45 E14 ideal for home use. Perfect for all types of applications, thanks to the multiple sizes and features. You will get more efficiency and savings in your electricity bill, while enjoying better lighting.

As lâmpadas esféricas LED P45 E14 Filux, são ideais para o uso doméstico perfeias para todos os tipos de aplicações, graças aos vários tamanhos e características. Permite-lhe uma maior eficiência poupança de energia, além de lhe permitir beneficiar melhor qualidade de iluminação.



4W/7W



Ø45x90 mm

3
YEAR
WARRANTY

✓
15.000H

CRI
>80

▬
220°

💧
IP20

E14

📦
100 PCS

⬢
SMD



Model	SKU	Power	C.Temp	Lumens	Input	€*
-------	-----	-------	--------	--------	-------	----

*Ecorae incluida | included | incluída * IVA no incluido | VAT not included | IVA não incluído

FT-1904	F1905	4W	3.000K	300	220-240V, 50Hz	1,51 €
	F1906		4.000K			
	F1904		6.500K			
FT-1907	F1908	7W	3.000K	700		1,63 €
	F1909		4.000K			
	F1907		6.500K			

C37 LED CANDLE BULB

Bombilla LED E14 de Filux de 4W y 7W de potencia, con una alta eficiencia energética y una vida útil de larga duración. Es ideal para sustituir a las antiguas bombillas de incandescencia con casquillo E14 de hasta 35W, consiguiendo un ahorro energético del 80%. Ofrece un encendido instantáneo y es respetuosa con el medio ambiente.

Filux LED bulb E14 of 4W and 7W of power, with high energy efficiency and long life duration. It's ideal to replace the old incandescence bulbs with E14 sockets of up to 35W, achieving an energy saving of 80%. It offers an instant start and is respectful with the environment.

Lâmpada vela LED E14 Filux com potências de 4W e 7W, com elevada eficiência energética e vida longa. São ideais para substituir as lâmpadas incandescentes de vela antigas com E14 de 35W, permite-nos uma poupança de energia de 80%. Têm acendimento instantâneo e respeita o meio ambiente.

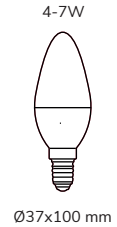

3
YEAR
WARRANTY

25.000H

CRI
>80

200°

SMD

IP20

E14

PF
>0,5

100 PCS



Model	SKU	Power	C.Temp	Lumens	Input	€*
-------	-----	-------	--------	--------	-------	----

*Ecoraee incluida | included | incluída * IVA no incluido | VAT not included | IVA não incluído

FT-1704	F1705	4W	3.000K	300	220-240V, 50Hz	1,50 €	
	F1706		4.000K				
	F1704		6.500K				
FT-1707	F1708	7W	3.000K	700		220-240V, 50Hz	1,62 €
	F1709		4.000K				
	F1707		6.500K				

G120 LED BULB 20W

La bombilla FT-1420 combina la eficiencia de la tecnología LED con un diseño muy característico el cual brinda una iluminación uniforme en los espacios en los cuales se utiliza. De encendido instantáneo y sin parpadeos, aportando un gran ahorro en el consumo de energía eléctrica.

The FT-1420 bulb combines the efficiency of LED technology with a very characteristic design which provides uniform illumination in the spaces in which it is used. Instantaneous and flicker-free ignition, providing great savings in electricity consumption.

A lâmpada de led FT-1420 combina a eficiência da tecnologia LED com um design muito característico que proporciona uma iluminação uniforme nos espaços em que é utilizada. Acendimento instantâneo e sem cintilações, proporcionando grande poupança de energia.

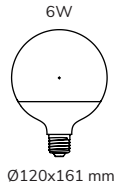

3
YEAR
WARRANTY

25.000H

CRI
>80

300°

IP20

E27

20 PCS

SMD



Model	SKU	Power	C.Temp	Lumens	Input	€*
FT-1420	F1626	20W	3.000K	1.700	175-250V, 50Hz	6,70 €
	F1627		4.000K			
	F1628		6.500K			

*Ecorae incluida | included | incluída * IVA no incluido | VAT not included | IVA não incluído

A60 LED FILAMENT BULB 6,7W

Las bombillas LED Filamento A60 con casquillo E27 de Filux son perfectas para todo tipo de aplicaciones. Sustitutas perfectas a las bombillas tradicionales. Las bombillas LED ofrecen un gran ahorro de energía, y mantenimiento.

The Filux filament LED bulbs A60 with socket E27 are perfect for all types of applications. They are a perfect replacement for traditional light bulbs. LED bulbs offer great energy savings, and maintenance.

As lâmpadas A60 de filamento LED E27 da Filux são a solução ideal para todos os tipos de aplicações. São a substituição ideal das lâmpadas incandescentes tradicionais. As lâmpadas LED permitem grandes poupanças de energia e manutenção.

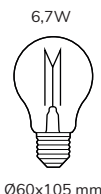

Model	Sku	Power	C.Temp	Lumens	Input	€*
-------	-----	-------	--------	--------	-------	----

*Ecoraee incluida | included | incluída * IVA no incluido | VAT not included | IVA não incluído

FT-1608	F1632	6,7W	2.700K	806	220-240V, 50Hz	3,00 €
---------	-------	------	--------	-----	-------------------	--------

3
YEAR
WARRANTY

CRI
>80

15.000H

FILAMENT

E27

320°

IP20

PF
>0,5

100 PCS

C37 LED CANDLE FILAMENT BULB 4W

Las bombillas LED Filamento C37 con casquillo fino E14 de Filux son perfectas para todo tipo de aplicaciones. Sustitutas perfectas a las bombillas tradicionales. Las bombillas LED ofrecen un gran ahorro de energía, y mantenimiento.

The Filux filament LED bulbs C37 with fine socket E14 are perfect for all types of applications. They are a perfect replacement for traditional light bulbs. LED bulbs offer great energy savings, and maintenance.

As lâmpadas vela LED de filamento C37 casquillo E14 da Filux são ideais para todos os tipos de aplicações. São a substituição perfeita das lâmpadas incandescentes tradicionais. As lâmpadas led permitem grandes poupanças de energia e manutenção.

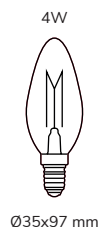

Model	Sku	Power	C.Temp	Lumens	Input	€*
-------	-----	-------	--------	--------	-------	----

*Ecoraee incluida | included | incluída * IVA no incluido | VAT not included | IVA não incluído

FT-1007	F1010	4W	2.700K	470	220-240V, 50Hz	2,27 €
---------	-------	----	--------	-----	-------------------	--------

3
YEAR
WARRANTY

CRI
>80

15.000H

FILAMENT

E14

320°

IP20

PF
>0,5

100 PCS

G9 LED BULB 2,5W

La bombilla LED FT-3725 nos permite sustituir a las bombillas halógenas tipo bi-pin con gran ahorro energético. Integrada con LEDs Epistar-SMD3014. No necesita transformador. Con tecnología LED de alta intensidad haciendo que una bombilla tan pequeña consiga una luz potente, clara y comfortable.

The FT-3725 LED bulb allows us to replace bi-pin halogen bulbs with a great energy saving. Integrates Epistar-SMD3014 LEDs. It does not need a transformer. With high intensity LED technology making a small bulb get a powerful light, clear and cozy.

A lâmpada LED FT-3725 casquilho G9, permite substituir as lâmpadas tipo bi-pino de halógeno com grande poupança de energia. Usa chip Epistar-SMD3014. Não necessita de transformador, pois é de ligação directa à rede 230V. Através de tecnologia de LED é possível numa lâmpada com medidas reduzidas obter uma luz potente clara e confortável.

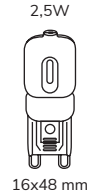

3
YEAR
WARRANTY

25.000H

CRI
>80

270°

IP20

G9

PF
>0,8

500 PCS

Model	Sku	Power	C.Temp	Lumens	Input	€*
*Ecoraee incluida included incluída * IVA no incluido VAT not included IVA não incluído						
FT-3725	F3701	2,5W	3.000K	200	220-240V, 50/60Hz	1,85 €
	F3702		4.000K			
	F3703		6.000K			

G4 LED BULB 1,5W

La bombilla G4 con un fujo luminoso de 120 lúmenes especialmente diseñada en reemplazo de las bombillas halógenas tanto lámparas decorativas como de techo. Con tecnología LED de alta intensidad haciendo que una bombilla tan pequeña consiga una luz potente, clara y comfortable.

The G4 bulb with a luminous flux level of 120 lumens, specially designed in replacemet of halogen bulbs in decorative and ceiling lights. Available in 3 light colors. With high intensity LED technology making a small bulb get a powerful light, clear and cozy.

A lâmpada G4 com um fluxo luminoso de 120 lumens especialmente desenvolvida para a substituição das lâmpadas de halógeno decorativas. Disponíveis em temperaturas de cor. Através de tecnologia de LED é possível numa lâmpada com medidas reduzidas obter uma luz potente clara e confortável.

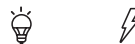
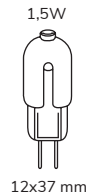

3
YEAR
WARRANTY

25.000H

CRI
>80

270°

IP20

G9

PF
>0,8

500 PCS

Model	Sku	Power	C.Temp	Lumens	Input	€*
*Ecoraee incluida included incluída * IVA no incluido VAT not included IVA não incluído						
FT-3726	F3704	1,5W	3.000K	120	DC 12V	1,85 €
	F3705		4.000K			
	F3706		6.000K			

R7S LED BULB

La bombilla LED FT-3811 R7S es el reemplazo de los antiguos halógenos lineales que podemos encontrar, por ejemplo en focos o lámparas de pie. De encendido instantáneo, sin parpadeos y mínima emisión de calor.

The LED bulb FT-3811 R7S is the replacement of the old linear halogens such as spotlights or floor lamps. The ignition is instantaneous, without flickers and minimum heat emission.

A lâmpada LED R7S FT-3811 permite a substituição lâmpadas antigas de halógeno lineares que podemos encontrar, por exemplo, em projectores ou candeeiros de pé. O acendimento é instantâneo, sem piscar e com emissão mínima de calor.

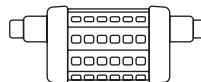

8W Ø29X78 mm
14,5W Ø29X118 mm

3
YEAR
WARRANTY

25.000H

CRI
>80

330°

TRIAC
DIMMABLE

IP20

R7S

PF
>0,9

100 PCS



Model	SKU	Power	C.Temp	Lumens	Input	€*
-------	-----	-------	--------	--------	-------	----

*Ecoraee incluida | included | incluída * IVA no incluido | VAT not included | IVA não incluído

FT-3811	F3813	8,5W	2.700K	1.060	220-240V	7,02 €
	F3814		4.000K			
	F3815	15W	2.700K	2.000		9,45 €
	F3816		4.000K			

LED FITTINGS



Model	Sku	mm	Cutting size (mm)	Material	IP	Color	€*
-------	-----	----	-------------------	----------	----	-------	----

Corte

*Ecoraee incluida | included | incluída * IVA no incluido | VAT not included | IVA não incluído

FT-1500	F1550	Ø 90	Ø 70	Steel-Iron Acero-Hierro Aço-Ferro	54	○	1,94 €	
	F1551	87x87					1,99 €	
	F1552	Ø 90				●	1,94 €	
	F1553	87x87					1,99 €	
	F1556	89x89	84x84	Aluminio Aluminium Alumínio		○	3,90 €	
	F1557	Ø 85	Ø 75				6,09 €	
	F1558	85x85				6,09 €		
	F1554	-	-			-	-	-

ACCESORIOS BOMBILLAS GU10

Model	SKU	mm	Cutting size (mm)	Material	Color	€*
Corte						
*Ecoraee inclusa included incluída * IVA no incluido VAT not included IVA não						
	F1560	Ø90X30	Ø75	Aluminio Aluminium Alumínio	● ●	1,97 €
	F1561				● ●	2,36 €
	F1562				● ●	
	F1563				○ ○	1,97 €
	F1564				○ ●	2,36 €
	F1565				○ ●	
	F1566				○ ●	1,97 €
	F1567				● ●	2,45 €
	F1568				● ●	



Model	SKU	mm	Cutting size (mm)	Material	Color	€*
Corte						
*Ecoraee incluida included incluída * IVA no incluido VAT not included IVA não						
FT-1500	F1570	93X93	Ø75	Aluminio Aluminium Alumínio	○	2,27 €
	F1569				●	
	F1571	93X173	75X150		○	5,02 €
	F1572				●	
	F1573	92X258	75X235		○	7,47 €
	F1574				●	
	F1575	Ø80X85			○	7,85 €
	F1576				●	
	F1577	80X80X85			○	9,93 €
	F1578				●	

Fabricamos à medida sob o solicitado On demand custom manufacturing

Fabricamos a medida sobre demanda

Los productos FILUX que están en el catálogo, son productos de alta rotación y demanda en el mercado actual. Se puede fabricar a medida bajo demanda cualquier tipo de iluminación que no esté presente en este catálogo.

The FILUX products that are in the catalogue, are products of high turnover and demand in the current market. Any type of LED lighting that is not present in this catalogue can be made to measure on demand.

Os produtos Filux apresentados são de elevada rotação, no entanto, podemos fabricar produtos com características diferentes se solicitado.

FILUX
BY FIT ENERGY

SITUAÇÃO GEOGRÁFICA

GEOGRAPHIC SITUATION

SITUACIÓN GEOGRÁFICA

Filux es una marca de Fit Energy y está situada geográficamente en Vitoria-Gasteiz, capital del País Vasco en España, una ciudad reconocida por la importante actividad industrial. Es una marca de economía real, que basa parte de su crecimiento en su expansión territorial. Para ello está creando una amplia red comercial y de establecimientos especializados en LEDs con firma propia o asociados.

Esta red cuenta en estos momentos con diversos puntos de venta y distribución en toda España y Portugal y así expandiéndose con varios puntos de distribución en Europa y la posibilidad de compra online a través de su web.

Filux is a Fit Energy brand is located geographically in Vitoria-Gasteiz, capital of the Basque Country in Spain, a city recognized for its important industrial activity. It is a real economy brand that bases part of its growth on its territorial expansion, for which it is creating an extensive commercial network and specialized stores in LEDs with their own firm or associates.

This network currently has various points of sale and distribution throughout Spain and Portugal and thus expanding with several distribution points in Europe and the possibility of online purchase through its website.

Filux é uma marca Fit Energy está localizada geograficamente em Vitoria-Gasteiz, capital do País Basco em Espanha e Portugal, uma cidade reconhecida pela sua importante atividade industrial. É uma marca da economia real que baseia parte de seu crescimento em sua expansão territorial, para a qual está a criar uma extensa rede comercial e especializadas em iluminação LED.

Atualmente, esta rede tem vários pontos de distribuição por Espanha, estando em franca expansão pela europa permitindo ainda a compra online através do nosso website

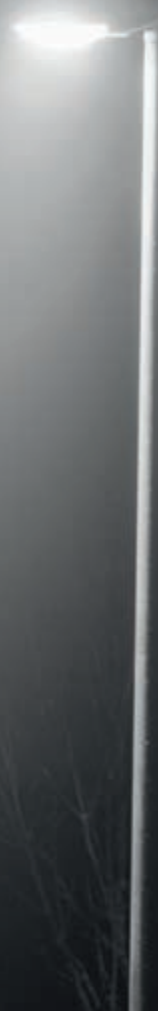

NOSSOS SERVIÇOS

OUR SERVICES

NUESTROS SERVICIOS



Equipo | Team | Equipa

Nuestro equipo está compuesto por un grupo de profesionales del sector de la iluminación LED, motivados, implicados y al servicio de la innovación y la mejora continua. Contamos con departamento de Ingeniería, diseño publicidad y marketing, departamento de administración, departamento de ventas, atención al cliente y logística.

Our team is composed of a group of professionals in the LED lighting sector, motivated, involved and at the service of innovation and continuous improvement, we have engineering department, design advertising and marketing, administration department, sales department, customer service and logistics.

A nossa equipa é constituída por um grupo de profissionais do sector de iluminação LED, fortemente motivados e com forte empenho no serviço de inovação e melhoria contínua. Dispomos departamento de engenharia, publicidade de design e marketing, departamento de administração, departamento de vendas, Atenção ao cliente e logística.



Soluciones | Solutions | Soluções

Contamos con distintos departamentos para brindar las soluciones que puedan surgir, como asesoramiento técnico y personalizado a nuestros clientes, un equipo de atención al cliente siempre dispuesto a resolver tus dudas y un equipo logístico para hacer que los pedidos lleguen cuando lo necesites entre otros servicios.

We have different departments to provide solutions that may arise, such as technical advice and personalized to our customers, a customer service team which is always willing to answer your questions and logistics team to place orders when you need it among other services .

Temos diferentes departamentos para fornecer várias soluções que possam surgir, tais como, apoio técnico, personalizado, uma equipa de atendimento ao cliente sempre disponível para responder a todas as questões e uma equipa de logística para dar seguimento às encomendas.



Garantía | Warranty | Garantia

FILUX, garantiza entre dos y cinco años, a partir de la fecha de compra, el funcionamiento de sus productos contra cualquier defecto en los materiales. Nuestra garantía incluye la reparación, reposición, o cambio del producto y/o componentes sin cargo alguno para el cliente.

Filux warranties are between 2 and 5 years from the day of the purchase, the performance of their products against any defect of the materials. Our warranties includes the reparations, replacement or change of any product and/or their components without any additional charge to the client.

As nossas garantias são de 2 e 5 anos a partir da data de compra, contra qualquer defeito de fabrico. As nossas garantias incluem reparações, substituição ou alteração de qualquer produto e / ou seus componentes sem qualquer custo adicional para o cliente.



Puntos de distribución | Distribution points | Pontos de distribuição

Filux irrumpió en un mercado que necesitaba productos de iluminación LED, que cumplieran con innovación, alta calidad y precio competitivo. 5 años más tarde, Filux consolida su posición como punto de referencia en España y Portugal y expande sus negocios al resto de Europa, representado en países como Francia, Italia, Inglaterra y Polonia.

Filux erupted in a market in need of LED products that accomplished innovation, high quality and a competitive price. Five years later, Filux consolidated their position as a reference point in Spain and Portugal. And it expands their business to the rest of Europe, being represented in countries such as France, Italy, the UK and Poland.

A Filux entrou num mercado que procura produtos de iluminação LED que atendam a inovação, alta qualidade e preço competitivo. Após 5 anos a Filux consolida a sua posição no mercado como uma empresa de referência no mercado Espanhol, e Português estando-se a expandir para o resto da Europa, tendo actualmente representações em França, Itália, Inglaterra e Polónia.



Servicio postventa | After-sales service | Serviço pós-venda

Contamos con servicio post venta rápido y de calidad, ya sea asesoramiento telefónico para instalación o, si los productos lo requieren, servicio de instalación. Nuestros empleados están capacitados para atender incidencias, escuchar al cliente, y brindar la mejor solución.

We have a fast and quality after-sales service, whether it's telephone advice for installation or if the products require installation service, our employees are trained to attend incidents, help the customer, and provide the best solution.

Temos um serviço de pós venda rápido de elevada qualidade, onde apoiamos e esclarecemos todas as dúvidas que os nossos clientes nos apresentam a cerca dos nossos produtos. A nossa equipa comercial dispõem de elevada formação técnica que permite solucionar os problemas ou dúvidas e aconselhar sobre qual a melhor solução para cada caso.

ESTUDOS LUMINOTÉCNICOS LIGHT TESTS

ESTUDIOS LUMÍNICOS

En nuestras instalaciones de Vitoria-Gasteiz, en España, contamos con profesionales y equipos altamente especializados, como nuestro espectrómetro, un gran instrumento que mide distintos datos de nuestras luminarias, así como la temperatura de color, flujo luminoso, índice de distribución de color, parámetros eléctricos, fotometrías y colorimetrías.

In our facilities of Vitoria-Gasteiz, in Spain, we have professionals and highly specialized equipment, like our spectrometer, a great instrument that measures different data from our luminaires, like color temperature, luminous flux, color distribution index, electrical parameters, photometry and colorimetry.

Nas nossas instalações em Vitória-Gasteiz, Espanha, dispomos de uma equipa de profissionais e de equipamentos altamente sofisticados, como o nosso espectrómetro, um instrumento que mede diferentes dados das nossas luminárias, bem como a temperatura da cor, fluxo luminoso, índice de distribuição de cores, parâmetros elétricos, fotometria e colorimetria, entre outros..



CERTIFICAÇÕES CERTIFICATIONS CERTIFICACIONES

RoHS

El certificado ROHS (Restriction of Hazardous Substances), garantiza la restricción de ciertas sustancias peligrosas en aparatos eléctricos y electrónicos. Pretende promover el reciclaje, la reutilización y la recuperación de los residuos de estos equipos para reducir su contaminación.

The ROHS certificate (Restriction of Hazardous Substances) guarantees the restriction of certain dangerous substances on electrical and electronic appliances. Its objective is to promote the recycle and recovery of the waste from these equipments to reduce their pollution.

O certificado ROHS (Restrição de Substâncias Perigosas) garante a restrição de certas substâncias perigosas em equipamentos elétricos e eletrônicos. O objetivo é promover a reciclagem, reutilização e recuperação de resíduos desses equipamentos por forma a reduzir a contaminação.



Para poder venderse en el Espacio Económico Europeo, muchos productos deben llevar obligatoriamente el marcado CE, que constituye la prueba de que el producto se ha evaluado y cumple los requisitos de seguridad, sanidad y protección del medio ambiente exigidos por la UE.

To be able to sell in the European Economic area they must carry the CE mark, this constitutes the proof that this product was evaluated and it complies with the requirements of security, health and protection of the environment required by the EU.

Para podermos vender os nossos produtos no espaço Económico Europeo, os produtos devem ter a marca CE, que funciona como prova de que o produto foi avaliado e cumpre os requisitos de segurança, saúde e proteção ambiental exigidos pela UE.



Entidad Nacional de Acreditación (Gov. de España). La certificación ENAC acredita el cumplimiento de los productos de la normativa vigente garantizando los resultados técnicos de las luminarias. Certificación disponible en algunos productos.

Entidad Nacional de Acreditación (Government of Spain). ENAC certification accredits compliance with the products of current regulations guaranteeing the technical results of the luminaires. Certification available on some products.

Entidad Nacional de Acreditación (Governo da Espanha). A certificação ENAC credencia a conformidade com os produtos das normas vigentes, garantindo os resultados técnicos das luminárias. Certificação disponível em alguns produtos.



Fundación eco-raee's es un Sistema Integrado de Gestión de Residuos de Aparatos Eléctricos y Electrónicos. Fundación eco-raee's representa a FIT Energy ofreciendo cobertura y asesoramiento en materia de recogida, traslado, almacenamiento y tratamiento de los residuos de aparatos eléctricos y electrónicos.

Eco-raee's foundation is an Integrated Waste Management System for Electrical and Electronic Equipment. Eco-raee's foundation represents FIT Energy offering coverage and advice on the collection, transfer, storage and treatment of waste electrical and electronic equipment.

Eco-raee's foundation é um Sistema Integrado de Gerenciamento de Resíduos de Equipamentos Elétricos e Eletrônicos. A eco-raee's foundation representa a FIT Energy, oferecendo cobertura e aconselhamento sobre a coleta, transferência, armazenamento e tratamento de resíduos de equipamentos elétricos e eletrônicos.

AVANÇO TECNOLÓGICO TECHNOLOGICAL ADVANCE AVANCE TECNOLÓGICO

La tecnología LED posee un alto potencial para mejorar nuestra calidad de vida; gracias a los más recientes avances tecnológicos, nuestro departamento técnico adapta a la perfección los diseños para su fabricación, haciendo mejor y más duraderos nuestros productos, permitiendo tener menor mantenimiento, más resistencia a los golpes, mejor eficiencia energética... es decir, estos avances nos permiten el desarrollo de productos LED cada vez más innovadores.

LED technology has a high potential to improve our life's quality, thanks to the latest technologies, our technical department perfectly adapts the designs for its manufacture, making better and more durable our products, less maintenance, more resistance to shocks, improving its energy efficiency, it means, these advances allow us to develop increasingly innovative LED products.

A tecnologia LED tem um elevado potencial para melhorar a nossa qualidade de vida, graças aos mais recentes avanços tecnológicos. O nosso departamento técnico adapta perfeitamente os nossos produtos para que na fase de fabricação, os torne com melhor desempenho bem como mais durabilidade, permitindo menos manutenção, maior resistência a choques, melhorando sua eficiência energética, ou seja, desenvolver produtos led cada vez mais inovadores.



VANTAGENS DA ILUMINAÇÃO LED ADVANTAGES OF LED LIGHTING

VENTAJAS DE LA ILUMINACIÓN LED

Cuando hablamos de las ventajas de la iluminación LED nos referimos a que el consumo de electricidad es mínimo, con un 80% de ahorro de energía y una duración de unas 10 veces más que una bombilla tradicional, siendo su vida útil de entre 30.000 y 70.000 horas dependiendo del producto. Son más resistentes a las temperaturas y generan mínima emisión de calor.

Usar tecnología LED es una alternativa sustentable, ecológica y eficiente.

When talking about the advantages of LED lighting we mean that the consumption of electricity is minimal, with savings of 80% energy, duration of about 10 times more than a traditional bulb, being its useful life between 30,000 and 70,000 hours depends on the product. They are more resistant to temperatures and generate minimal heat emission.

Using LED technology is a sustainable, ecological and efficient alternative.

Quando falamos sobre as vantagens da iluminação de LED afirmamos que o consumo de eletricidade é mínimo, com uma poupança de 80% de energia e uma duração de 10 vezes mais que uma lâmpada tradicional, atendendo uma vida útil de 30.000 a 70.000 horas.

Utilizar tecnologia LED é uma alternativa sustentável, ecológica e eficiente.

SEJA NOSSO DISTRIBUIDOR BE OUR DISTRIBUTOR SÉ NUESTRO DISTRIBUIDOR

Queremos que trabajes con nosotros, ser más competitivos en el sector de la iluminación, y para ello te presentamos nuestro catálogo de suministros LED.

Al trabajar con nosotros podrás realizar mejores presupuestos en tus instalaciones y beneficiarte de numerosas ventajas.

We want you to work with us, to be more competitive in the LED lighting market, and for that we present you our catalogue of LED supplies.

When working with us you will be able to realize better budgets for your instalations and benefit from numerous advantages.

Gostaríamos que fosse nosso parceiro de negócio, ser mais competitivo no sector de iluminação e por esse motivo apresentamos o nosso catálogo de iluminação LED.

Ao ser nosso parceiro, irá ter maior facilidade na execução de propostas comerciais além de ir beneficiar de inúmeras vantagens.



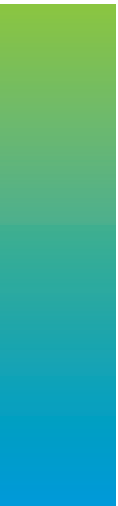















INFORMAÇÃO CATÁLOGO CATALOGUE INFO

INFORMACIÓN CATÁLOGO

Dentro de este catálogo, podrás ver distintos iconos que explicamos a continuación.

Within this catalogue, you will see different icons explained below.















Neste catálogo, serão apresentados símbolos diferentes que explicaremos de seguida.

Vida útil Useful life Vida útil	Lúmenes/wattios Lumens/watts Lúmenes/watt	Compatible con NEMA NEMA Compliant Em conformidade com NEMA	Protección IP IP protection Proteção IP	Tipo de LED LED type Tipo de LED	Cambio color de temperatura Color temperature switch Mudar a temperatura de cor	Chip Chip Chip
						
50.000H	160LM/W	NEMA Compatible	IP65	FILAMENT	K 3000 4000 6000 ALL IN ONE	LUMILEDS
						
IK08	CRI >80	E27	PF >0,95	5 YEAR WARRANTY	MOTION SENSOR	1-10 V
Protección IK IK protection Proteção IK	Índice de reproducción cromática Color rendering index Índice de reprodução cromática	Conector Connector Casquilho	Factor de potencia Power factor Fator de potência	Garantía Warranty Garantia	Sensor de movimiento Motion sensor Sensor de movimento	Regulación Regulation Regulação

Nossos símbolos

Our icons

Nuestros iconos

Driver Driver Transformador	Regulación del tiempo Time dimming Temporizador	Ángulo de apertura Beam angle Ângulo de abertura	Temperatura de trabajo Working temperature Temperatura de trabalho	Dimensiones Dimensions Dimensões	Unidades por embalaje Units per pack Unidades por embalagem	Precio Price Preço
 MEANWELL	 TIME DIMMING	 120°	 W.TEMP	 DIMENSIONS	 100 PCS	
 SHAPE	 POWER	 4KV	 W	 UGR <19	 LUMENS	 ADJUSTABLE
Forma Shape Forma	Energía Power Potência	Protección contra sobretensión Surge protection Proteção contra sobretensão	Vatios Watts Watts	Índice de deslumbramiento unificado Unified glare rating Classificação de brilho unificado	Lúmenes Lumens Lúmenes	Dirección de posición ajustable Adjustable position direction Direção da posição ajustável

TERMINOLOGIA

TERMINOLOGY

TERMINOLOGÍA

ESP

LÚMENES: Es la intensidad luminosa uniforme repartida en un ángulo sólido de un estereorradián y su flujo luminoso total emitido en esta dirección se llama lumen. Una manera más sencilla de definir lumen sería decir que es la cantidad total de luz visible en una dirección o ángulo proyectada sobre una superficie.

LM/W: Lúmenes emitidos por cada vatio de electricidad.

WATIO: Unidad de medida de potencia.

EN

LUMENS: It is the uniform luminous intensity distributed in a solid angle of a steradian and its total luminous flux emitted in this direction is called lumen. A simpler way to define lumen would be to say that it is the total amount of light visible in a direction or angle projected onto a surface.

LM/W: This calculation indicates the amount of lumens emitted per watt of electricity.

WATT: Unit of measurement of power.

PT

LUMENS: é a unidade de medida de fluxo luminoso. Um lúmen é o fluxo luminoso total emitido em uma direção ou ângulo projectado em uma superfície.

LM / W: esta unidade de medida indica o número de lúmenes emitidos por watt de eletricidade.

WATT: unidade de medida de potência.

EQUIVALENCIA EN WATIOS: Es la comparativa entre Watios/Lúmenes de una bombilla convencional aplicada a la tecnología LED.

VOLTAJE / FRECUENCIA: El voltaje es la fuerza que impulsa los electrones. La frecuencia es el número de veces que se repite la señal en un determinado tiempo. Ambos son componentes de la corriente alterna.

CRI: El CRI o Índice de Reproducción Cromática es una medida de la capacidad que una fuente luminosa tiene para reproducir fielmente los colores de varios objetos en comparación con una fuente de luz natural o ideal.

EQUIVALENCE IN WATTS: It is the comparison between watts / lumens of a light bulb applied to LED technology.

VOLTAGE / FREQUENCY: Voltage is the force that drives the electrons. The frequency is the number of times the signal is repeated in a certain time. Both are components of the alternating current.

CRI: The CRI or Chromatic Reproduction Index is a measure of the ability of a light source to faithfully reproduce the colors of various objects compared to a natural or ideal light source.

EQUIVALÊNCIA EM WATTS: é a comparação entre watts / lumens de uma lâmpada aplicada à tecnologia LED.

TENSÃO / FREQUÊNCIA: a tensão é a força que impulsiona os elétrons. A frequência é o número de vezes que o sinal é repetido em um determinado tempo. Ambos são componentes da corrente alternada.

CRI: o cri ou índice de reprodução de cores é uma medida da capacidade de uma fonte de luz para reproduzir com exatidão as cores de vários objetos em comparação com uma fonte de luz natural ou ideal.

PF: El Factor de Potencia es el porcentaje de energía que es aprovechada por un sistema electrónico como luminarias LED, televisiones, ordenadores o cualquier aparato electrónico. Este dato es importantísimo para saber el aprovechamiento energético del equipo y determinar su calidad.

ÁNGULO DE APERTURA: Es un parámetro importante, especialmente en las lámparas de iluminación directa. El ángulo de apertura de luz nos indica si la lámpara iluminará un área más grande o más pequeña.

PF: The Power Factor is the percentage of energy that is taken advantage of by an electronic system such as LED luminaires, televisions, computers or any electronic device. This data is very important to know the energy use of the equipment and determine its quality.

BEAM ANGLE: It is an important parameter, especially in direct lighting lamps. The opening angle of light tells us if the lamp will illuminate a larger or smaller area.

PF: o fator de potência é a percentagem de energia que é usada por um sistema eletrônico, como luminárias led, televisões, computadores ou qualquer dispositivo eletrônico. Estes dados são muito importantes para conhecer o uso de energia do equipamento e de determinar a sua qualidade.

ÂNGULO DE ABERTURA: é um parâmetro importante, especialmente em lâmpadas de iluminação direta. O ângulo de abertura da luz indica se a lâmpada iluminará uma área maior ou menor.

EMPOTRABLE: Es una luminaria que la podremos instalar en un techo falso.

SUPERFICIE: Es una luminaria que la podremos instalar pegada al techo, ideales para lugares donde no hay techo falso.

PROTECCIÓN IP: Las características de IP indican la medida en que está protegida una lámpara de objetos, el polvo y la humedad. Las características IP constan de dos dígitos: Primer dígito: protección contra la entrada de polvo y objetos, Segundo dígito: protección contra el agua.

RECESSED: It is a luminaire that we can install on a false ceiling.

SURFACE: It is a luminaire that can be installed sticking under the ceiling, ideal for places where there is no false ceiling.

IP PROTECTION: The IP characteristics indicate the extent to which an object lamp, dust and moisture is protected. The IP characteristics consist of two digits: First digit: protection against the entry of dust and objects, Second digit: protection against water.

ENCASTRAR: é uma luminária que podemos instalar em um teto falso, encastrável.

SUPERFÍCIE: é uma luminária que podemos instalar de modo superfície, ideal para locais onde não há teto falso.

PROTEÇÃO IP: As características do IP são apresentadas por dois dígitos: primeiro dígito: proteção contra pequenos resíduos sólidos, segundo dígito: proteção contra líquidos.

TEMPERATURA DE COR

COLOR TEMPERATURE

TEMPERATURA DE COLOR

ESP

Dos luces blancas pueden ser completamente distintas. Seguro que lo ha notado cuando, tras reemplazar una bombilla fundida (algo cada vez menos frecuente gracias a la iluminación LED), ha percibido la habitación de modo diferente. Se debe a que ha colocado una bombilla, también blanca y de la misma potencia, pero con distinta temperatura de color.

La temperatura de color podría definirse como la sensación que percibe el ojo humano ante una luz, siendo cálida si predomina el color ámbar o fría si predomina el azul. Esta medición solo se aplica a la luz blanca y técnicamente se define como "la impresión de color a ciertas temperaturas de un radiador de cuerpo negro perfecto", según la guía de la Federación de Asociaciones Europeas de Luminarias y Componentes para Luminarias.

El concepto es más simple de lo que parece. Piense en un hierro incandescente al que se le va aplicando cada vez más calor. Cuando su temperatura se sitúa a unos 1.000 K (grados kelvin) adquiere una tonalidad rojiza. Si la temperatura sube hasta situarse entre 2.000 y 3.000 K su color se vuelve amarillento. A 4.000 K su tono es blanco neutro y entre 5.000 y 7.000 K blanco frío. Sin embargo, cuando hablamos de luz, la "temperatura" es sólo una medida relativa: no tiene que ver con el calor físico sino con la sensación que produce en el ojo humano.

EN

Two white lights can be completely different. Surely you have noticed when, after replacing a fused light bulb (something less and less frequent thanks to LED lighting), you have perceived the room differently. It is because you have placed a bulb, also white and of the same power, but with different color temperature.

The color temperature could be defined as the sensation that the human eye perceives about a light, being warm if the amber prevails or cold color if the blue predominates. This measurement only applies to white light and is technically defined as the "color printing at certain temperatures of a perfect black body radiator", according to the guide of the Federation of European Luminaires and Components Associations for Luminaires.

The concept is simpler than it seems. Think of an incandescent iron that is getting more and more heat. When its temperature is about 1,000 K (Kelvin degrees) it takes on a reddish hue. If the temperature rises to between 2,000 and 3,000 K its color turns yellowish. At 4,000 K its tone is neutral white and between 5,000 and 7,000 K cold white. However, when we speak of light, "temperature" is only a relative measure: it has nothing to do with physical heat but with the sensation it produces in the human eye.

PT

Duas luzes brancas podem ser completamente diferentes. Certamente já notou que, depois de substituir uma lâmpada fundida (algo cada vez menos frequente graças à iluminação por LED), o ambiente apresenta-se de forma diferente. É porque colocou uma lâmpada, também branca e com a mesma potência, mas com temperatura de cor diferente.

A temperatura de cor pode ser definida como a sensação percebida pelo olho humano antes de uma luz, sendo quente se âmbar ou frio se predominar, a cor azul. Esta medição aplica-se apenas à luz branca e é tecnicamente definida como "a emissão de cores a determinadas temperaturas de um corpo negro radiador", de acordo com o guia da federação de associações de componentes e luminárias europeias.

O conceito é mais simples do que parece. Pense num ferro incandescente ao qual se vai aplicando mais e mais calor. Quando sua temperatura está em torno de 1.000 k (graus kelvin), ela adquire uma tonalidade avermelhada. Se a temperatura subir entre 2.000 e 3.000 K, a sua cor fica amarelada. Aos 4.000 k seu tom é branco neutro e entre 5.000 e 7.000 K branco frio. No entanto, quando falamos de luz, "temperatura" é apenas uma medida relativa: não tendo nenhuma relação com o calor físico, mas com a sensação que produz no olho humano.

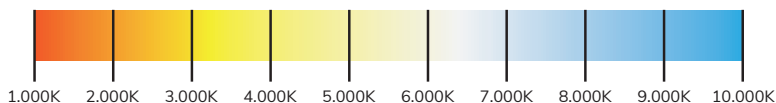

Condiciones generales de venta y suministro de FIT Energy S.L. para europa

GENERALIDADES: Para la venta y suministro que realice FIT Energy, S.L. serán de aplicación las siguientes condiciones generales.

OFERTAS: Nuestras ofertas, bien escritas u orales, se entienden sin compromiso por nuestra parte, son sólo a título informativo, salvo que especialmente se pactara lo contrario, nosignificando en ningún caso compromiso de aceptación del pedido.

PEDIDOS: Son aceptados con la condición expresa de que queda reservado el derecho de modificar los precios y condiciones de venta por nuestra parte. En los casos de modificación de pedidos con suministros parciales, los clientes tendrán la facultad de anular las mercancías que quedaren pendientes de suministro, o bien aceptar el resto del pedido con las nuevas condiciones.

PRECIOS: Los precios se entienden por mercancías puestas en los Almacenes de FIT Energy, S.L. incluidos los embalajes normales (las dimensiones del embalaje de envío pueden variar dependiendo de la procedencia de la mercancía), siendo por cuenta del cliente cualquier protección o embalaje adicional. Franquicia de portes de 10 €, para pedidos con valor base mínimo de 300 € en península y de 1.000 € en Canarias, Baleares, Ceuta y Melilla, portes gratis.

Por su parte, los costes de envíos realizados a otros países de Europa deberán consultarse previamente a la finalización del proceso de compra ya que dependerán de diferentes condiciones, entre otras, el importe de la compra, lugar de envío, envío urgente, etc.

SUMINISTROS: Las mercancías viajan por cuenta y riesgo del comprador, aunque en los albaranes figuren portes pagados, con independencia del medio de transporte utilizado, cuya elección queda reservada a FIT Energy, S.L.

En caso de rotura, robo, avería, naufragio y extravío, el comprador o destinatario podrá reclamar al transportista, eximiendo a FIT Energy, S.L. de responsabilidad alguna en cuanto a la falta de material o al tiempo transcurrido en la expedición. El comprador asumirá los gastos que se produzcan en el transporte, siempre que, atendiendo a sus peticiones, éste se realizará por algún medio o agencia de transportes elegido por él mismo. FIT Energy, S.L. podrá realizar suministros y, consecuentemente, facturaciones parciales referidas a pedidos del comprador.

PLAZOS: Los plazos de entrega se consideran siempre aproximados y no podrá exigirse responsabilidad a causa de retrasos por fuerza mayor u otras circunstancias propias o ajenas a la voluntad de FIT Energy, S.L. no dando derecho al comprador a indemnizaciones ni anulaciones en los pagos por los pedidos realizados.

PAGOS: Salvo pacto en contrario, el pago se realizará en Vitoria-Gasteiz en las condiciones convenidas por ambas partes. En caso de demora en los pagos, se cargará al comprador el interés correspondiente, así como cualquier gasto de renovación o aplazamiento si lo hubiere. Queda reservada a FIT Energy, S.L. la facultad de fijar a cualquier

cliente el límite o cuantía máxima de crédito a conceder, así como suspender los suministros en el caso de tener el cliente pagos atrasados.

DEVOLUCIONES DE MATERIAL: No se admitirán devoluciones de material sin previa solicitud por parte del cliente y aprobación por parte de FIT Energy, S.L.

No se aceptará la devolución en los siguientes casos:

- a) Materiales que están descatalogados.
- b) Materiales que hayan sido usados con anterioridad a la devolución.
- c) Devoluciones en malas condiciones físicas, bien del material en sí o de los embalajes.
- d) Materiales no fabricados o comercializados por FIT Energy, S.L.
- e) Materiales cuyo suministro se realizó con anterioridad superior a seis meses a la fecha de la solicitud de devolución.
- f) Para realizar una propuesta de devolución es necesario indicar el número de factura o albarán del material que se pretende devolver.
- g) Salvo pacto en contrario, a la devolución se le aplicará un 5% de depreciación, FIT Energy, S.L. no se hará cargo de las devoluciones que no se remitan a portes pagados, resarcido posteriormente al cliente, en los casos que proceda.

Siempre que el comprador acreditara devolver el material por defectos técnicos imputables al mismo, será necesario el dictamen o comprobación técnica del mismo, o de la instalación donde estuviere montado, por FIT Energy, S.L., que así lo confirme, en cuyo caso se resarcirá al comprador mediante abono o sustitución gratuita del material adquirido, sin que pueda exigirse daño o perjuicios de clase alguna.

RECLAMACIONES: FIT Energy, S.L., no aceptará reclamaciones relativas a errores en las cantidades o tipos recibidas por el cliente, siempre que no se realicen dentro de los 48 horas siguientes a la fecha en que se efectuó el suministro.

VIARIOS: Para cualquier divergencia que pudiera resultar en el cumplimiento e interpretación de las operaciones realizadas por FIT Energy, S.L. y su cliente, éste, con renuncia expresa de su propio fuero, o legislación, se somete expresamente a la jurisdicción de los Tribunales y Juzgados de Vitoria-Gasteiz. Estas condiciones derogarán cualesquiera otras de fecha anterior a las mismas y permanecerán vigentes por tiempo indeterminado, en tanto no se establezcan otras nuevas con el mismo objeto.

*Para consultar las condiciones generales completas de venta visitar la web: <http://ecommerce.fitenergy.es/> contenido/condiciones-generales.

General conditions of sale and supply of FIT Energy S.L. for europe

GENERAL: For the sale and supply made by FIT Energy, S.L. the following general conditions will be applied.

OFFERS: Our offers, whether written or oral, are understood without commitment on our part, are only for information, unless otherwise agreement. That means, there is in no case commitment to accept the order.

ORDERS: They are accepted with the express condition that the right to modify the prices and conditions of sale by us is reserved. In cases of modification of orders with partial supplies, customers will have the power to cancel the goods that remain pending supply, or accept the rest of the order with the new conditions.

PRICES: The prices are understood by merchandise placed in the Warehouses of FIT Energy, S.L. including normal packaging (the dimensions of the shipping carton may vary depending on the origin of the goods), being the customer's account any additional protection or packaging. Freight charge of € 10, for orders with a minimum base value of 300 € in the peninsula and 1.000 € in the Canary Islands, Balearic Islands, Ceuta and Melilla, free of charge.

Moreover, the shipping costs to other European countries should be previously consulted at the end of the purchase process, because they will depend on various conditions, e.g., the amount of the purchase, place of delivery, express delivery, etc.

SUPPLIES: The goods travel at the buyer's risk and expense, even if the delivery notes are paid freight, regardless of the means of transport used, whose choice is reserved for FIT Energy, S.L. In case of breakage, theft, damage, wreckage and loss, the buyer or recipient can claim the carrier, exempting FIT Energy, S.L. of any responsibility regarding the lack of material or the time elapsed in the expedition. The buyer will assume the expenses that occur in the transportation, provided that, according to his requests, this will be done by some means or transport agency chosen by him. FIT Energy, S.L. may make supplies and, consequently, partial invoices referred to buyer's orders.

DEADLINES: The delivery times are always considered approximate and no liability can be demanded due to delays due to force majeure or other circumstances of their own or outside the will of FIT Energy, S.L. not giving the buyer the right to compensations or cancellations in the payments for the orders placed.

PAYMENTS: Unless otherwise agreed, payment shall be made in Vitoria-Gasteiz under the conditions agreed by both parties. In case of delay in payments, the buyer will be charged the corresponding interest, as well as any expenses of renewal or postponement if any. Reserved for FIT Energy, S.L. the power to set any client the limit or maximum amount of credit to be granted, as well as suspend the supplies in case the customer has late payments.

RETURNS OF MATERIAL: No refunds of material will be accepted without prior request from the customer and approval by FIT Energy, S.L. The refund will be not accepted in the following cases:

- a) Materials that are discontinued.
- b) Materials that have been used prior to the return.
- c) Returns in bad physical condition, either of the material itself or of the packaging.
- d) Materials not manufactured or marketed by FIT Energy, S.L.
- e) Materials whose supply was made earlier than six months prior to the date of the return request.
- f) To make a return proposal it is necessary to indicate the invoice number or delivery note of the material to be returned.
- g) Unless otherwise agreed, a 5% depreciation will be applied to the return, FIT Energy, S.L. will be not responsible for returns that are not shipped paid, subsequently recouping the client, in appropriate cases.

Whenever the buyer proves to return the material for technical defects imputable to the products, it will be necessary the opinion or technical verification of the products, or of the installation where they are installed, by FIT Energy, SL, that confirms it, in that case purchaser will be compensated by free substituting or replacing the purchased material, without any damages or damages of any kind.

CLAIMS: FIT Energy, S.L., will not accept claims regarding errors in the quantities or types received by the customer, provided that they are not made within 48 hours following the date on which the supply was made.

VARIOUS: For any divergence that could result in the compliance and interpretation of the operations carried out by FIT Energy, S.L. and his client, expressly waiving his or her own jurisdiction, or legislation, is expressly subject to the jurisdiction of the Tribunals and Courts of Vitoria-Gasteiz. These conditions will abrogate any others dated prior to them and will remain in force indefinitely, as long as other new ones with the same object are not established.

* To consult the general conditions of sale visit the web: <http://ecommerce.fitenergy.es/contenido/condiciones-generales>.

Condições gerais de venda e fornecimento da FIT Energy S.L.

para a europa

GERAL: Para a venda e fornecimento da FIT Energy, S.L. aplicam-se as seguintes condições gerais.

PROPOSTAS: As nossas propostas, sejam escritas ou verbais, são entendidas sem compromisso de nossa parte, são apenas para fins informativos, salvo acordo especial em contrário, o que significa, que em nenhum caso, compromisso para aceitar a encomenda.

ENCOMENDAS: Elas são aceites com a condição expressa de que o direito de modificar os preços e condições de venda são reservadas a FIT Energy, S.L. Nos casos de modificação de encomendas com suprimentos parciais, os clientes terão o direito de cancelar os produtos que estejam pendentes de fornecimento ou aceitar o restante da encomenda com as novas condições.

PREÇOS: Os preços são entendidos como produtos colocadas nos armazéns da FIT Energy, S.L. incluem embalagem normal (as dimensões da embalagem podem variar dependendo da origem do produto), com qualquer proteção adicional ou embalagem sendo paga pelo cliente. Valor de portes de envio de 10€, para encomendas com um valor inferior a 300€.

Os custos de envio de productos enviados para outros países europeus devem ser consultados antes da conclusão do processo de compra, uma vez que dependerão de condições diferentes, entre outros, o valor da compra, local de entrega, entrega urgente, etc.

FORNECIMENTOS: As mercadorias viajam por conta e risco do comprador, embora as notas de remessa incluam o porte pago, independentemente do meio de transporte utilizado, cuja escolha está reservada à FIT Energy, S.L.

EEEm caso de quebra, roubo, avaria, naufrágio e perda, o comprador ou destinatário pode reclamar á transportadora, ficando a FIT Energy, S.L. isenta de qualquer responsabilidade em relação à falta de material ou o tempo decorrido na expedição. O comprador assumirá as despesas que ocorrerem no transporte, desde que, de acordo com seus pedidos, este seja realizado por qualquer meio ou agência de transporte escolhida por ele. FIT Energy, S.L. pode fazer fornecimentos e, conseqüentemente, faturas parciais referiam-se a ordens do comprador.

PRAZOS: Os prazos de entrega são sempre considerados aproximados e nenhuma responsabilidade pode vir a ser exigida pelos atrasos devido a força maior ou outras circunstâncias próprias ou fora do controle da FIT Energy, S.L. não dando ao comprador o direito de compensação ou cancelamento de pagamentos por pedidos efetuados.

PAGAMENTOS: Salvo acordo em contrário, o pagamento será feito em vitoria-gasteiz, nas condições acordadas por ambas as partes. Em caso de atraso nos pagamentos, ao comprador será cobrado os juros correspondentes, bem como quaisquer despesas de renovação ou adiamento, se houver. É reservado para a FIT Energy, S.L. o poder definir a qualquer cliente o limite do montante máximo de crédito concedido, bem como suspender os fornecimentos no caso de o cliente ter atrasos nos pagamentos.

DEVOLUÇÕES DO MATERIAL: Reembolsos de material não serão aceites sem solicitação prévia do cliente e aprovação por escrito pela FIT Energy, S.L. o retorno não será aceito nos seguintes casos:

- a) Materiais descontinuados.
- b) Materiais que foram usados antes do retorno.
- c) Retorna em más condições físicas, seja do próprio material ou da embalagem.
- d) Materiais não fabricados ou comercializados pela FIT Energy, S.L.
- e) Materiais cujo fornecimento foi feito á mais de seis meses antes da data do pedido de devolução.
- f) Para fazer uma proposta de devolução, é necessário indicar o número da fatura ou nota de remessa do material que deve ser devolvido.
- g) Salvo acordo em contrário, será aplicada uma depreciação de 5% ao retorno,a FIT Energy, S.L. não será responsável por devoluções que não sejam enviadas em frete pago, subseqüentemente reembolsando o cliente, nos casos apropriados.

Sempre que o comprador creditado para retornar o material atribuível aos mesmos defeitos técnicos, a opinião ou a sua monitorização, ou a instalação onde a pessoa foi montado pela FIT Energy, S.L. que eles confirmam, caso em que será necessário reembolsar o comprador por pagamento ou substituição gratuita do material adquirido, sem qualquer dano ou prejuízo de qualquer espécie pode ser exigido.

REIVINDICAÇÕES: a FIT Energy, S.L., não aceitará reclamações relativas a erros nos valores ou tipos recebidos pelo cliente, desde que não sejam feitas dentro de 48 horas após a data em que o fornecimento foi feito.

DIVERSOS: Para qualquer divergência que possa resultar em conformidade e interpretação das operações realizadas pela FIT Energy, S.L. e seu cliente, que renuncia expressamente à sua própria jurisdição ou legislação, se submete expressamente à jurisdição dos tribunais de vitoria-gasteiz. Estas condições revogarão quaisquer outras datas anteriores e permanecerão em vigor por um período indefinido, desde que não sejam estabelecidas novas para o mesmo fim.

*Para consultar as condições gerais de venda visite a web: <http://ecommerce.fitenergy.Es/contenido/condiciones-generales>.

A photograph of the Aurora Borealis (Northern Lights) in shades of green and yellow, reflected in a calm body of water. The scene is dark, with the lights providing the primary illumination. Large, semi-transparent geometric shapes in shades of green and grey are overlaid on the image.

FILUX

ILUMINACIÓN LED PROFESIONAL

FILUX.COM



Portal de Zurbano, 13
01013 Vitoria-Gasteiz, España.
+34 945 292 773
filux.com