

ATMOSS[®]
LIGHTING



NEW
PRODUCTS

ENERO 2025



Iluminación



SAMSUNG LED Inside



			°K		Ref	PVPR
Lámpara LED Mini SAMSUNG	G9	2,5W	200Lm	3200K	BLED-423	5,07€
Lámpara LED Mini SAMSUNG	G9	2,5W	200Lm	4200K	BLED-424	5,07€
Lámpara LED Mini SAMSUNG	G9	2,5W	200Lm	5000K	BLED-425	5,07€

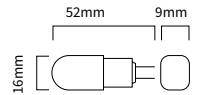

				°K	Ref	PVPR
Lámpara LED Mini SAMSUNG	G9	3W	350Lm	3200K	BLED-426	5,64€
Lámpara LED Mini SAMSUNG	G9	3W	350Lm	4200K	BLED-427	5,64€
Lámpara LED Mini SAMSUNG	G9	3W	350Lm	5000K	BLED-428	5,64€

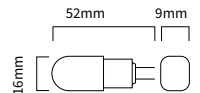

				°K	Ref	PVPR
Lámpara LED Mini SAMSUNG	G9	4W	450Lm	2700K	BLED-453	5,94€
Lámpara LED Mini SAMSUNG	G9	4W	450Lm	3200K	BLED-429	5,94€
Lámpara LED Mini SAMSUNG	G9	4W	450Lm	4200K	BLED-430	5,94€
Lámpara LED Mini SAMSUNG	G9	4W	450Lm	5000K	BLED-431	5,94€

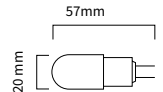

				°K	Ref	PVPR
Lámpara LED Mini SAMSUNG	G9	4W	450Lm	3200K	BLED-435	8,94€
Lámpara LED Mini SAMSUNG	G9	4W	450Lm	4200K	BLED-436	8,94€
Lámpara LED Mini SAMSUNG	G9	4W	450Lm	5000K	BLED-437	8,94€



SOLO REGULACIÓN TRIAC

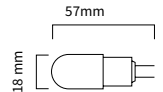

				°K	Ref	PVPR
Lámpara LED Mini SAMSUNG	G9	4W	550Lm	3200K	BLED-432	7,53€
Lámpara LED Mini SAMSUNG	G9	4W	550Lm	4200K	BLED-433	7,53€
Lámpara LED Mini SAMSUNG	G9	4W	550Lm	5000K	BLED-434	7,53€

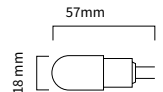

				°K	Ref	PVPR
Lámpara LED Mini SAMSUNG	G9	5W	650Lm	3200K	BLED-438	7,89€
Lámpara LED Mini SAMSUNG	G9	5W	650Lm	4200K	BLED-439	7,89€
Lámpara LED Mini SAMSUNG	G9	5W	650Lm	5000K	BLED-440	7,89€

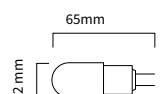



				°K		Ref	PVPR
Lineal LED Mini SAMSUNG		5W	500Lm	300°	2700K	BLED-445	20,88€
Lineal LED Mini SAMSUNG		5W	500Lm	300°	3200K	BLED-446	20,88€
Lineal LED Mini SAMSUNG		5W	500Lm	300°	4200K	BLED-447	20,88€
Lineal LED Mini SAMSUNG		5W	500Lm	300°	5000K	BLED-448	20,88€

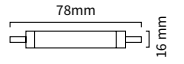

SOLO REGULACIÓN TRIAC



					°K		Ref	PVPR
Lineal LED Mini SAMSUNG		8W	900Lm	300°	2700K	BLED-449	26,22€	
Lineal LED Mini SAMSUNG		8W	900Lm	300°	3200K	BLED-450	26,22€	
Lineal LED Mini SAMSUNG		8W	900Lm	300°	4200K	BLED-451	26,22€	
Lineal LED Mini SAMSUNG		8W	900Lm	300°	5000K	BLED-452	26,22€	

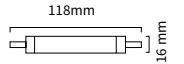

SOLO REGULACIÓN TRIAC

Dicroica 3CCT

IDEAL PARA TECHOS BAJOS

DIFERENTES ESTANCIAS

3 en 1 TRES TIPOS DE LUZ
EN LA MISMA LUMINARIA

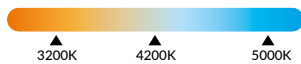

Switch CCT

3200K/4200K/5000K

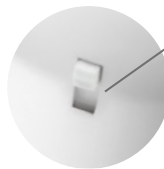

DICROICA LED 7W GU10 3CCT 60°

3CCT

Ref

PVPR

DIC-094

3,96€

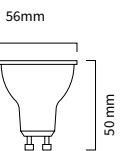

ESPECIAL PARA TECHOS BAJOS

DICROICA LED COMPACTA CON CABLE

3CCT

Ref

PVPR

DIC-095

6,48€

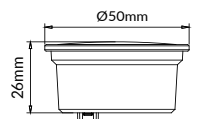



2700K



3000K



4000K

Bombilla standard A60 5CCT

5 en 1 **TRES TIPOS DE LUZ**
EN LA MISMA LUMINARIA

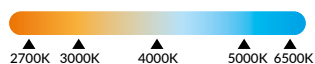

5000K



6500K



	Ref	PVPR	
STANDARD A60 E27 11W	<i>1100lm 5CCT</i>	BLED-417	4,68€
STANDARD A60 E27 13W	<i>1300lm 5CCT</i>	BLED-418	5,64€
STANDARD A60 E27 16W	<i>1600lm 5CCT</i>	BLED-419	5,94€

BOMBILLAS PAR30



	K°	Ref	PVPR
PAR30 BLANCO	<i>E27 30w 2600lm</i> 3200K	BLED-416	34,62€
PAR30 BLANCO	<i>E27 30w 2600lm</i> 4200K	BLED-420	34,62€

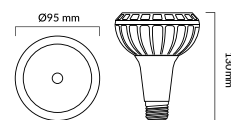

	K°	Ref	PVPR
PAR30 NEGRO	<i>E27 30w 2600lm</i> 3200K	BLED-421	34,62€
PAR30 NEGRO	<i>E27 30w 2600lm</i> 4200K	BLED-422	34,62€

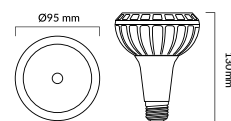

ESPECIAL
COCINA

BATERÍA USB

Ref

PVPR

REGLETA CON SENSOR DE MOVIMIENTO 40CM

RGL-365

35,07€



SENSOR PIR
MOVIMIENTO



Gran
autonomía



Batería - 2000mAh

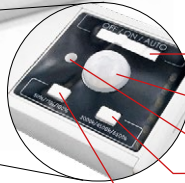
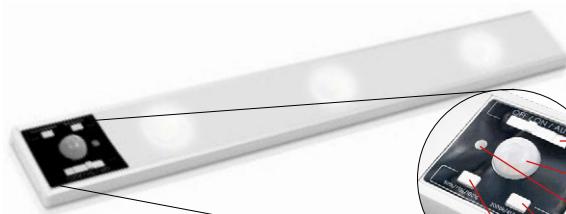

OFF/ON/AUTO

OFF - Apagado
On - Modo continuo de luz
Auto - Modo percepción movimiento

SENSOR PIR

INDICADOR DE CARGA

INTERRUPTOR SELECTOR 3CCT

INTENSIDAD DE LUZ



Tubo led con sensor



BASE G13

TUBO LED RADAR SENSOR 18W 1200mm 160° 5000K TUB-044 15,84€



1800 Lm



IP 54



160°

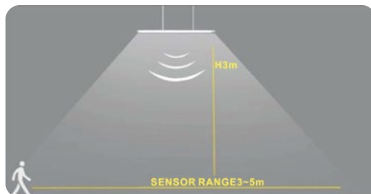
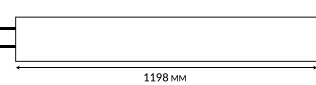

- Distancia detección hasta 5mts
- Altura 3mts
- Tiempo encendido 1min



AJUSTE DE COLORES
Cambia facilmente el color desde el switch

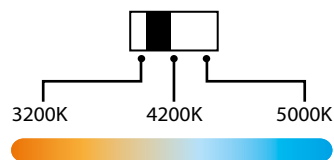

DOWNLIGHT	3CCT	15W	1200Lm	IP40	K°	Ref	PVPR
					CCT	DOW-458	21,66€

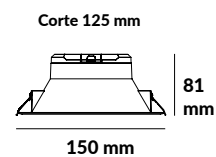



Track light



Ángulo de luz
REGULABLE



ALUMINIO - CONEXIÓN CARRIL TRIFÁSICO - LED INTEGRADO

		K°	Ref	PVPR
LED TRACK LIGHT	25w Negro	3200K	TRCK-076	50,52€
LED TRACK LIGHT	25w Negro	4200K	TRCK-075	50,52€
LED TRACK LIGHT	25w Blanco	4200K	TRCK-077	50,52€

25w
2700 Lm
230 v
↓

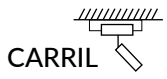

		Ref	PVPR
BASE SUPERFICIE REDONDO TRIFÁSICO	Blanco	TRCK-071	5,76€
BASE SUPERFICIE REDONDO TRIFÁSICO	Negro	TRCK-072	5,76€



		Ref	PVPR
BASE EMPOTRAR REDONDO TRIFÁSICO	Blanco	TRCK-073	6,48€
BASE EMPOTRAR REDONDO TRIFÁSICO	Negro	TRCK-074	6,48€



Track light empotrado

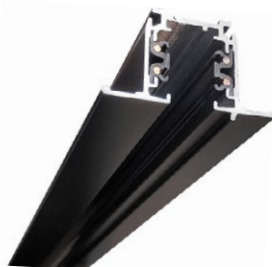

		Ref	PVPR
TRACK RAIL EMPOTRAR 4 HILOS	2Metros Negro	TRCK-083	82,32€
TRACK RAIL EMPOTRAR 4 HILOS	2Metros Blanco	TRCK-084	82,32€
TRACK RAIL EMPOTRAR 4 HILOS	3Metros Negro	TRCK-085	123,45€
TRACK RAIL EMPOTRAR 4 HILOS	3Metros Blanco	TRCK-086	123,45€

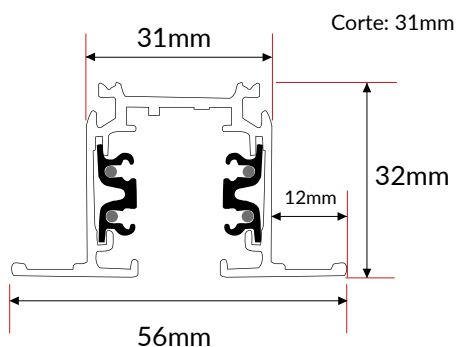

ESQUEMA DE CONEXIÓN TRACK RAIL

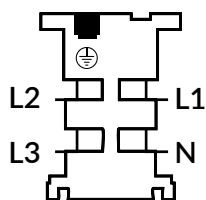

CONECTOR INICIAL
VISTA FRONTAL
NEUTRO DERECHA
TRCK-009/023

VISTA FRONTAL
ORIENTACIÓN
NEUTRO DERECHA
CONEXIÓN CON R

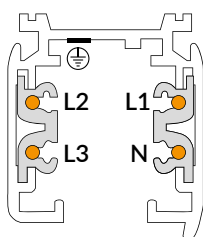

VISTA FRONTAL
ORIENTACIÓN
NEUTRO IZQUIERDA
CONEXIÓN CON L

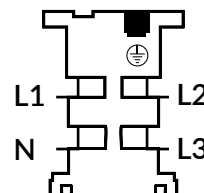
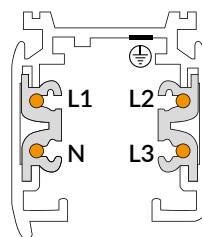

CONECTOR INICIAL
VISTA FRONTAL
NEUTRO IZQUIERDA
TRCK-038/037

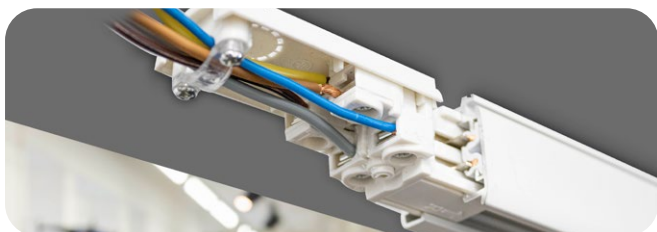

Ejemplo de conexión
con las tres fases.

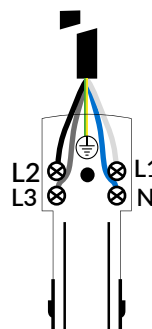

CONECTOR INICIAL
VISTA SUPERIOR
NEUTRO DERECHA
TRCK-009/023

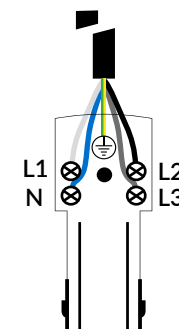

CONECTOR INICIAL
VISTA SUPERIOR
NEUTRO IZQUIERDA
TRCK-038/037

**RESPECTAR LA ORIENTACIÓN DEL NEUTRO PARA LA CONEXIÓN.
LAS CONEXIONES ENTRE ACCESORIOS Y TRACK RAIL SE
REALIZARÁN SIEMPRE CONECTANDO "R" CON "L" O VICEVERSA.**

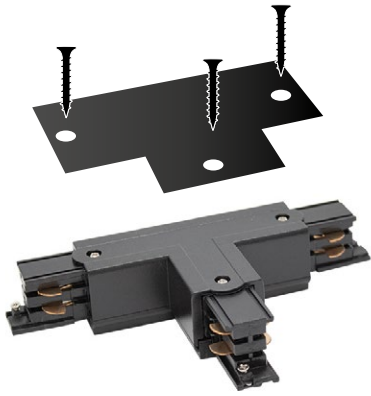

Haz tu instalación empotrada



Se puede adquirir la cubierta para hacer tu instalación empotrada.



PARA TRCK-009/023 - TRCK-038/037



CUBIERTA PARA CONECTOR INICIAL

Negro

Ref

TRCK-087

PVPR

1,14€

CUBIERTA PARA CONECTOR INICIAL

Blanco

TRCK-088

1,14€



PARA TRCK-003/017



CUBIERTA PARA TRCK UNION "I"

Negro

TRCK-091

1,86€

CUBIERTA PARA TRCK UNION "I"

Blanco

TRCK-092

1,86€



PARA TRCK-006/020 - 039/040



CUBIERTA PARA TRCK UNION "L"

Negro

TRCK-089

1,86€

CUBIERTA PARA TRCK UNION "L"

Blanco

TRCK-090

1,86€



PARA TRCK-004/018 - 043/046 - 044/047 - 045/048



CUBIERTA PARA TRCK UNION "T"

Negro

TRCK-093

2,25€

CUBIERTA PARA TRCK UNION "T"

Blanco

TRCK-094

2,25€



PARA TRCK-007/021



CUBIERTA PARA TRCK UNION "X"

Negro

TRCK-095

2,61€

CUBIERTA PARA TRCK UNION "X"

Blanco

TRCK-096

2,61€

ACCESORIOS TRACK LIGHT Ficha técnica



	Ref	PVPR
TAPA FINAL PARA RAIL BLANCO	Blanco TRCK-010	1,02€
TAPA FINAL PARA RAIL NEGRO	Negro TRCK-024	1,02€



CONECTOR INICIAL PARA RAIL CON TAPA BLANCO DERECHA	Blanco TRCK-009	7,35€
CONECTOR INICIAL PARA RAIL CON TAPA NEGRO DERECHA	Negro TRCK-023	7,35€



CONECTOR INICIAL PARA RAIL CON TAPA BLANCO IZQUIERDA	Blanco TRCK-038	7,35€
CONECTOR INICIAL PARA RAIL CON TAPA NEGRO IZQUIERDA	Negro TRCK-037	7,35€



UNIÓN "I" PARA RAIL BLANCO	Blanco TRCK-003	12,51€
UNIÓN "I" PARA RAIL NEGRO	Negro TRCK-017	12,51€



UNIÓN "I" INTERIOR PARA RAIL BLANCO	Blanco TRCK-051	7,35€
UNIÓN "I" INTERIOR PARA RAIL NEGRO	Negro TRCK-052	7,35€



UNIÓN "L" PARA RAIL BLANCO DERECHA	Blanco TRCK-006	12,81€
UNIÓN "L" PARA RAIL NEGRO IZQUIERDA	Negro TRCK-020	12,81€



UNION "L" PARA RAIL BLANCO IZQUIERDA	Blanco TRCK-039	12,81€
UNION "L" PARA RAIL NEGRO DERECHA	Negro TRCK-040	12,81€



UNIÓN "T" PARA RAIL BLANCO IZQUIERDA-ARRIBA	Blanco TRCK-004	19,44€
UNIÓN "T" PARA RAIL NEGRO IZQUIERDA-ARRIBA	Negro TRCK-018	19,44€



UNIÓN "T" PARA RAIL BLANCO IZQUIERDA - BAJO	Blanco TRCK-043	19,44€
UNIÓN "T" PARA RAIL NEGRO IZQUIERDA - BAJO	Negro TRCK-046	19,44€

UNIÓN "T" PARA RAIL BLANCO DERECHA - ARRIBA	Blanco TRCK-044	19,44€
UNIÓN "T" PARA RAIL NEGRO DERECHA - ARRIBA	Negro TRCK-047	19,44€

UNIÓN "T" PARA RAIL BLANCO DERECHA - BAJO	Blanco TRCK-045	19,44€
UNIÓN "T" PARA RAIL NEGRO DERECHA - BAJO	Negro TRCK-048	19,44€



UNIÓN "X" PARA RAIL BLANCO DERECHA	Blanco TRCK-007	24,24€
UNIÓN "X" PARA RAIL NEGRO DERECHA	Negro TRCK-021	24,24€



UNIÓN "FLEX" PARA RAIL BLANCO	Blanco TRCK-005	20,97€
UNIÓN "FLEX" PARA RAIL NEGRO	Negro TRCK-019	20,97€

REDONDO



ACCESORIOS SUSPENSIÓN 1 METRO PARA RAIL BLANCO	Blanco TRCK-008	17,28€
ACCESORIOS SUSPENSIÓN 1 METRO PARA RAIL NEGRO	Negro TRCK-022	17,28€

NEW! CUADRADO

ACCESORIOS SUSPENSIÓN 1 METRO PARA RAIL BLANCO	Blanco TRCK-065	6,75€
ACCESORIOS SUSPENSIÓN 1 METRO PARA RAIL NEGRO	Negro TRCK-066	6,75€

Esquema instalación

CONECTOR INICIAL

TRCK-009/023 TRCK-038/037

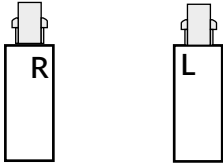

UNIÓN "I"

TRCK-003/017 TRCK-051/052

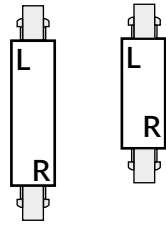

UNIÓN "T"
TRCK-004/018

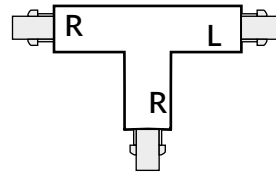

UNIÓN "T"
TRCK-043/046

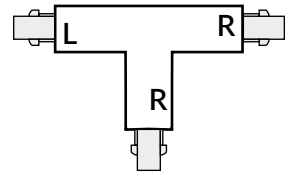

UNIÓN "T"
TRCK-044/047

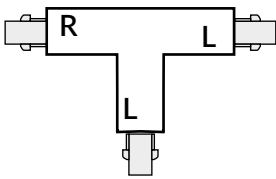

UNIÓN "T"
TRCK-045/048

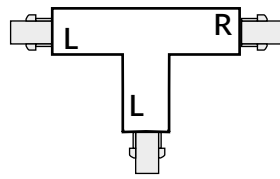

UNIÓN "L"
TRCK-006/040

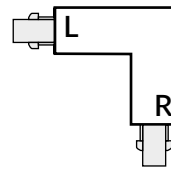

UNIÓN "L"
TRCK-039/020

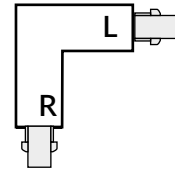

UNIÓN "X"
TRCK-007/021

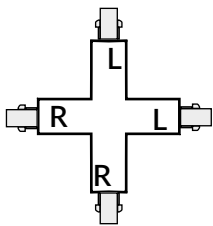

UNIÓN "FLEX"
TRCK-005/019

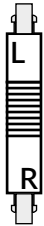

EJEMPLO INSTALACIÓN

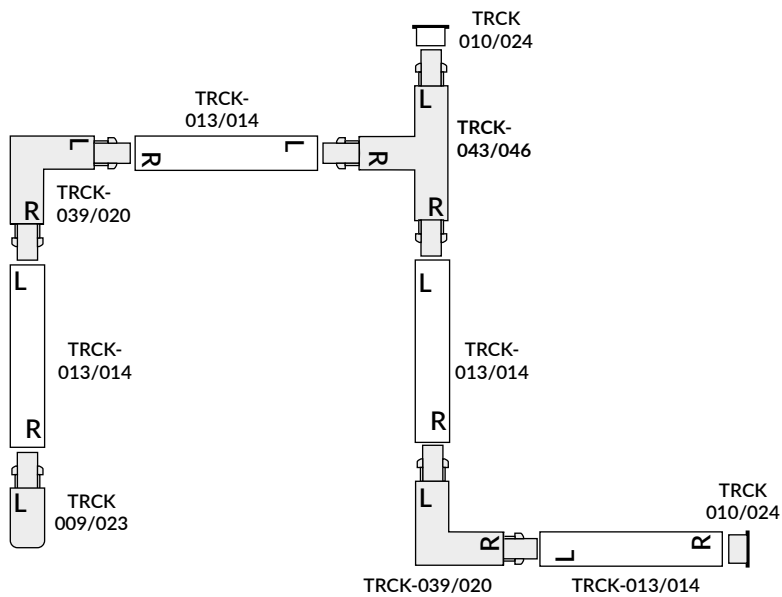



Apliques

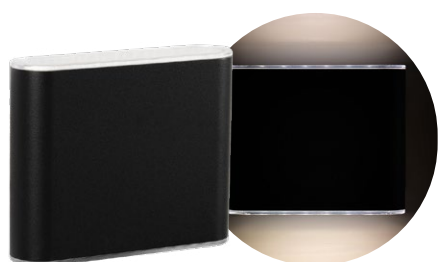

* Led incluido

SERIE ALUMINIO

APLIQUE EXTERIOR ALUMINIO 3CCT **6W** **3CCT** **APQ-470** **37,86 €**

6w
800 Lm
180°
230 v
IP 65
↓

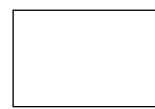

115 mm



48 mm

90 mm

K° **Ref** **PVPR**

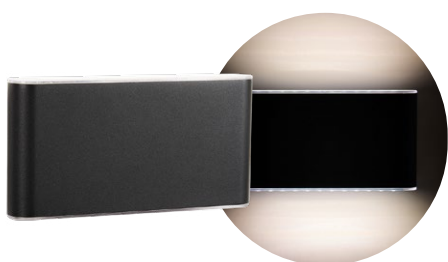

* Led incluido

SERIE ALUMINIO

APLIQUE EXTERIOR ALUMINIO 3CCT **12W** **3CCT** **APQ-471** **40,20 €**

12w
1500 Lm
180°
230 v
IP 65
↓

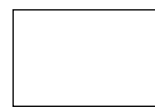

175 mm



48 mm

90 mm

K° **Ref** **PVPR**

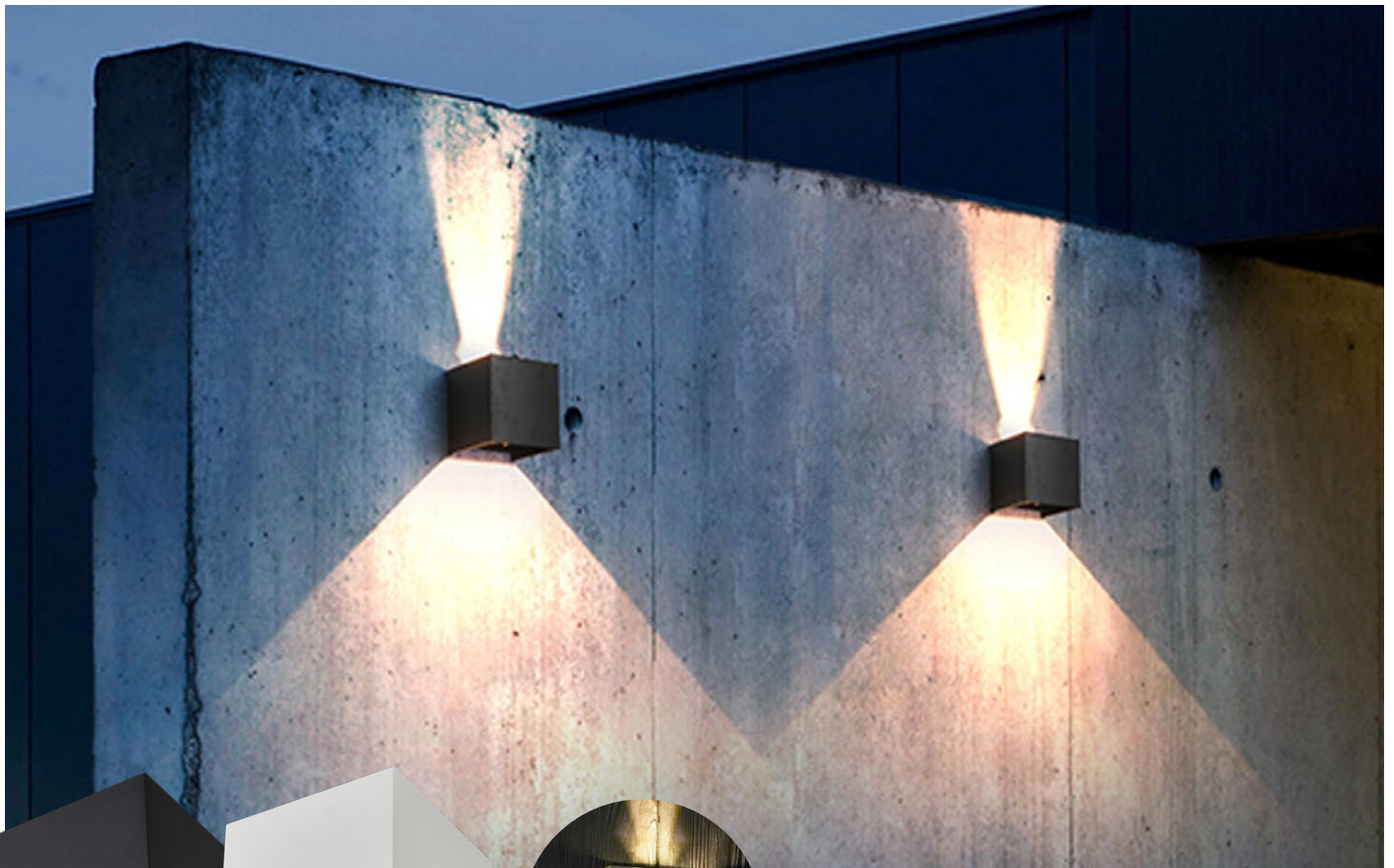

* Led incluido

SERIE ALUMINIO

			K°	Ref	PVPR
APLIQUE EXTERIOR CUADRADO ALUMINIO	Negro	6W	3CCT	APQ-474	36,36 €
APLIQUE EXTERIOR CUADRADO ALUMINIO	Blanco	6W	3CCT	APQ-475	36,36 €

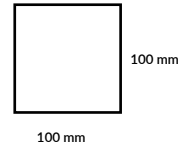

* Led incluido

SERIE ALUMINIO

			K°	Ref	PVPR
APLIQUE EXTERIOR OVAL ALUMINIO	Negro	6W	3CCT	APQ-472	39,54 €
APLIQUE EXTERIOR OVAL ALUMINIO	Blanco	6W	3CCT	APQ-473	39,54 €

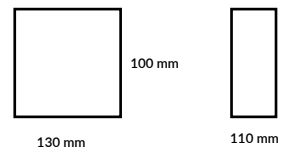



Apliques Exterior

IP 65



3 en 1 TRES TIPOS DE LUZ EN LA MISMA LUMINARIA

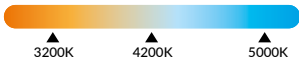

* Led incluido

SERIE PLASTIC

		K°	Ref	PVPR
APLIQUE LED REDONDO	Antracita - 15W	CCT	APQ-486	20,22 €
APLIQUE LED CUADRADO	Antracita - 15W	CCT	APQ-487	20,22 €

15w
1500 Lm
100°
230 v
IP 65
20

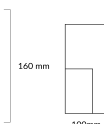
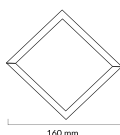
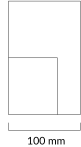

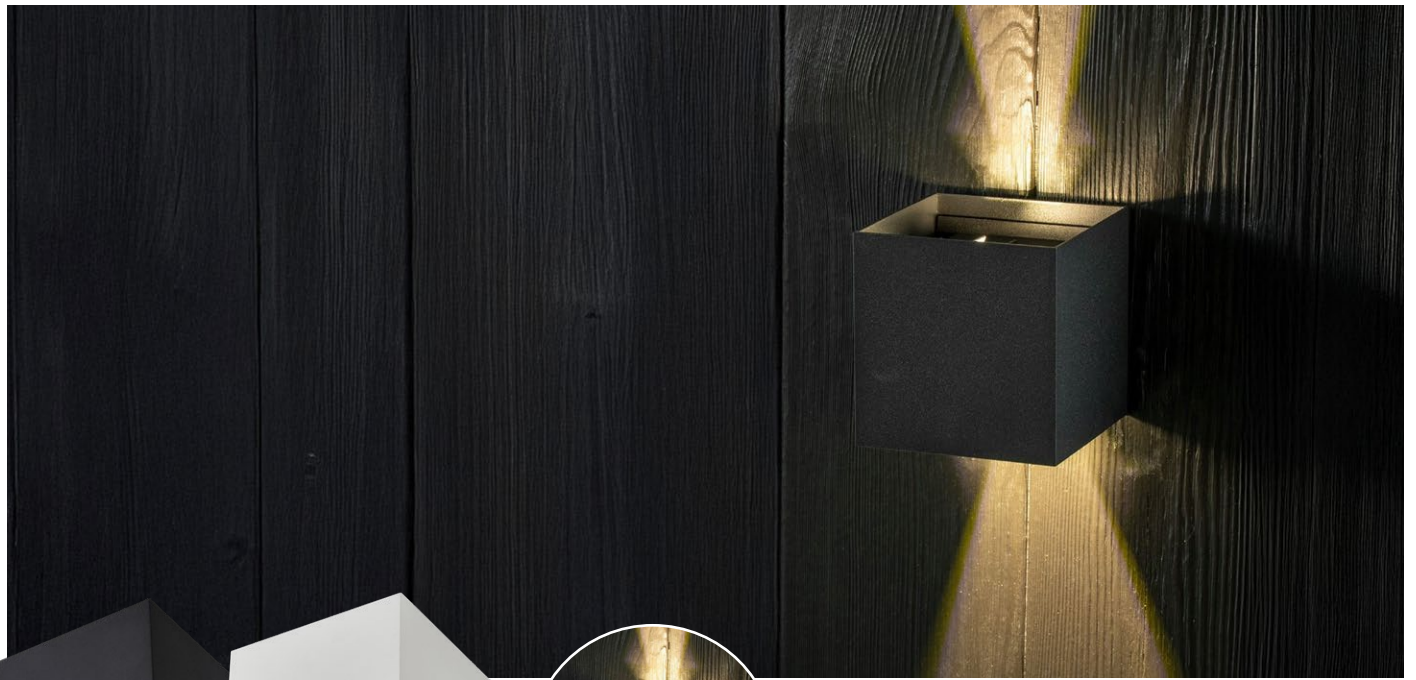

* Led NO INCLUIDO - Incluye portalámparas

SERIE ALUMINIO

		Ref	PVPR
APLIQUE EXTERIOR CUADRADO ALUMINIO	Negro MÁX 4W	APQ-476	27,60€
APLIQUE EXTERIOR CUADRADO ALUMINIO	Blanco MÁX 4W	APQ-477	27,60€

Aplique para Bombilla G9
(Bombilla no incluida)

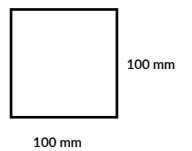

* Led NO INCLUIDO - Incluye portalámparas

SERIE ALUMINIO

		Ref	PVPR
APLIQUE EXTERIOR OVAL ALUMINIO	Negro MÁX 6W	APQ-478	26,82€
APLIQUE EXTERIOR OVAL ALUMINIO	Blanco MÁX 6W	APQ-479	26,82€

Aplique para Bombilla G9
(Bombilla no incluida)

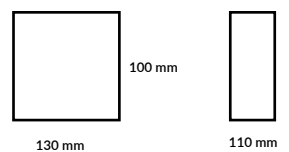

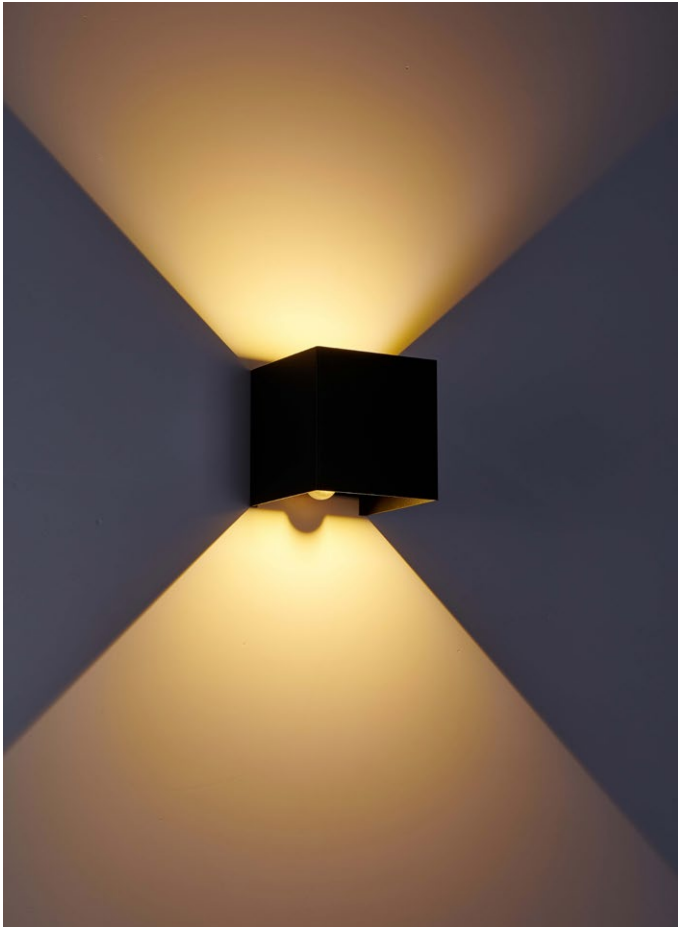

LED INCLUIDO

SERIE ALUMINIO

APLIQUE LED EXTERIOR CUADRADO

Negro

10W

3200K



Ref APQ-488

PVPR

31,62€

10w

1000 Lm

230 v

IP 65

SENSOR PIR MOVIMIENTO



SENSOR CREPUSCULAR

- Distancia detección 3 mts
- Tiempo encendido 30-40 seg

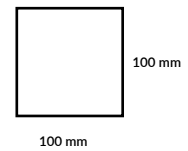

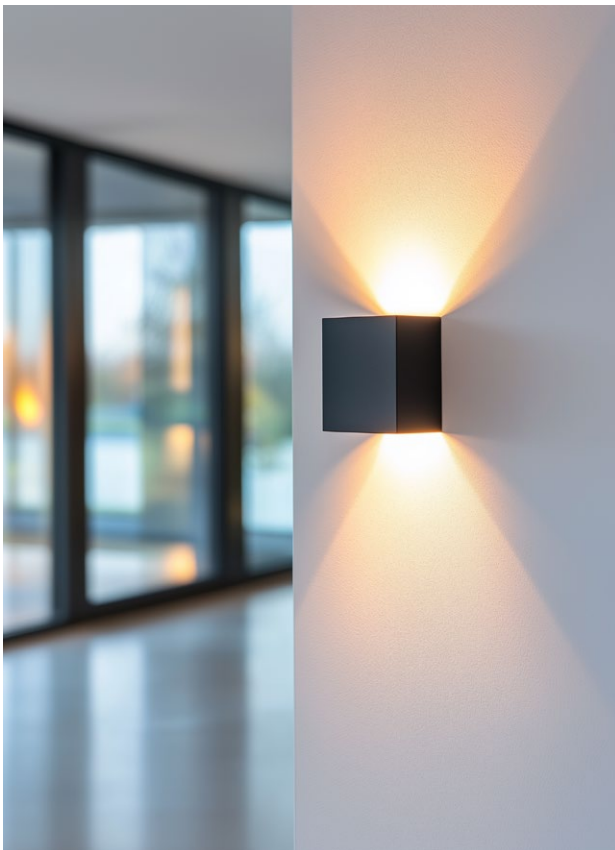

LED INCLUIDO

SERIE ALUMINIO

				Ref	PVPR
APLIQUE LED INTERIOR CUADRADO	Negro	6W	3200K	APQ-501	16,80€
APLIQUE LED INTERIOR CUADRADO	Negro	6W	5000K	APQ-502	16,80€

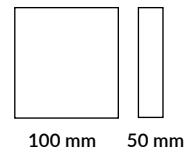

LED INCLUIDO

SERIE ALUMINIO

				Ref	PVPR
APLIQUE LED INTERIOR CUADRADO	Blanco	6W	3200K	APQ-503	16,80€
APLIQUE LED INTERIOR CUADRADO	Blanco	6W	5000K	APQ-504	16,80€

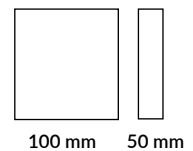



* Led NO INCLUIDO - Incluye portalámparas

SERIE ALUMINIO

			Ref	PVPR
APLIQUE EXTERIOR CIRCULAR ANILLO	Negro	MÁX 7W	APQ-480	35,52€
APLIQUE EXTERIOR CIRCULAR ANILLO	Blanco	MÁX 7W	APQ-481	35,52€

Aplique para Bombilla GU10
(Bombilla no incluida)

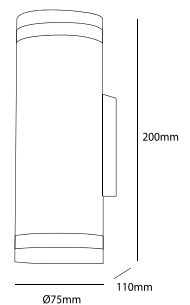



* Led **NO INCLUIDO** - Incluye portalámparas

SERIE ALUMINIO

Ref PVPR

APLIQUE EXTERIOR RECTANGULAR ANILLO	Negro	MÁX 7W	APQ-482	27,90€
APLIQUE EXTERIOR RECTANGULAR ANILLO	Blanco	MÁX 7W	APQ-483	27,90€

Aplique para Bombilla GU10
(Bombilla no incluida)

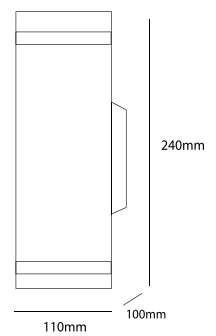



Apliques de escalera



LED INCLUIDO

SERIE ALUMINIO

APLIQUE LED EXTERIOR EMPOTRADO

Negro

3W

2700K



Ref APQ-506

PVPR 23,40€

3w

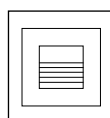

57 mm



35 mm

Cubierta protectora
Corte: 48x48x46mm



48 mm



46 mm



LED INCLUIDO

SERIE ALUMINIO

					Ref	PVPR
APLIQUE LED EXTERIOR REDONDO	Negro	3W	3200K	●	APQ-489	23,76€
APLIQUE LED EXTERIOR REDONDO	Negro	3W	4200K	●	APQ-490	23,76€

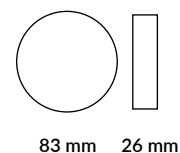

LED INCLUIDO

SERIE ALUMINIO

					Ref	PVPR
APLIQUE LED EXTERIOR REDONDO	Negro	3W	3200K	●	APQ-491	32,34€
APLIQUE LED EXTERIOR REDONDO	Negro	3W	4200K	●	APQ-492	32,34€



- Distancia detección 3 mts
- Tiempo encendido 30-40 seg

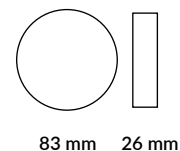

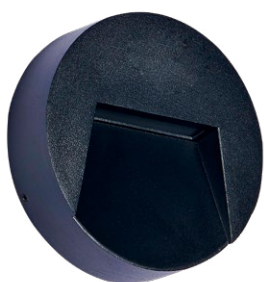

LED INCLUIDO

SERIE ALUMINIO

					Ref	PVPR
APLIQUE LED EXTERIOR REDONDO	Negro	3W	3200K	●	APQ-493	25,95€
APLIQUE LED EXTERIOR REDONDO	Negro	3W	4200K	●	APQ-494	25,95€

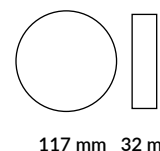

117 mm 32 mm

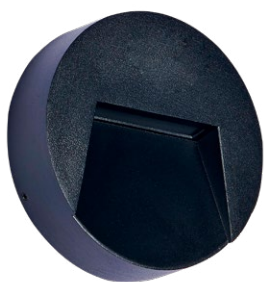

LED INCLUIDO

SERIE ALUMINIO

					Ref	PVPR
APLIQUE LED EXTERIOR REDONDO	Negro	3W	3200K	●	APQ-495	34,50€
APLIQUE LED EXTERIOR REDONDO	Negro	3W	4200K	●	APQ-496	34,50€



- Distancia detección 3 mts
- Tiempo encendido 30-40 seg

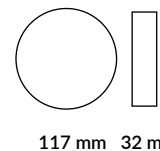

117 mm 32 mm



LED INCLUIDO

SERIE ALUMINIO

					Ref	PVPR
APLIQUE LED EXTERIOR CUADRADO	Negro	3-5W	2700K	●	APQ-505	27,75€
APLIQUE LED EXTERIOR CUADRADO	Negro	3-5W	3200K	●	APQ-497	27,75€
APLIQUE LED EXTERIOR CUADRADO	Negro	3-5W	4200K	●	APQ-498	27,75€

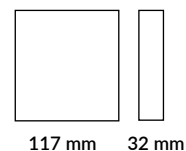

LED INCLUIDO

SERIE ALUMINIO

					Ref	PVPR
APLIQUE LED EXTERIOR CUADRADO	Negro	3-5W	3200K	●	APQ-499	36,24€
APLIQUE LED EXTERIOR CUADRADO	Negro	3-5W	4200K	●	APQ-500	36,24€



- Distancia detección 3 mts
- Tiempo encendido 30-40 seg

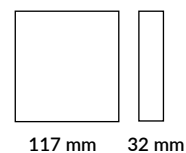



SERIE ALUMINIO

PANEL-CRISTAL

LÁMPARA DE PIE CON PANEL DE CRISTAL

Negro MÁX 28W

Ref PVPR

APQ-485 47,82€

Lámpara para Bombilla E27
(Bombilla no incluida)



SERIE ALUMINIO

PANEL-CRISTAL

APLIQUE DE PARED CON PANEL DE CRISTAL

Negro MÁX 28W

Ref PVPR

APQ-484 40,92€

Lámpara para Bombilla E27
(Bombilla no incluida)





Gama Solar

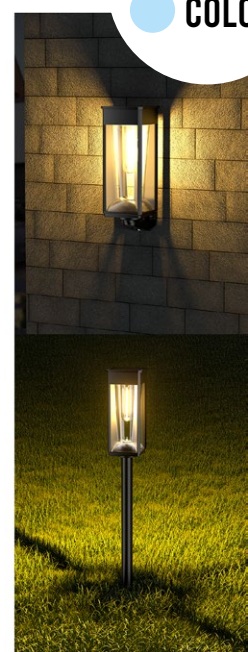

Incluido Acc de pared y suelo

SERIE PLASTIC

LED INCLUIDO

APLIQUE SOLAR PARED/SUELO
DUAL COLOR 3200K / 5000K

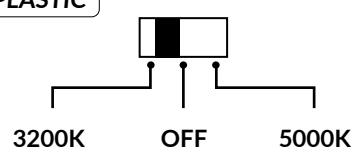

Ref	PVPR
APQ-076	8,95€

- IP 65
- Batería 3.7V 600mAh
- Panel solar - 5V 80mA
- Gran autonomía
- Carga solar 6-8Hrs





BATERÍA: 3.7V 1500mAh

SERIE PLASTIC

Ref

PVPR

APLIQUE LED SOLAR PARED 2 DIRECCIONES

IP65

3200K



APQ-071

23,28€



IP 65

150 Lm



Ángulo de luz AJUSTABLE



BATERÍA: 3.7V 1500mAh

SERIE PLASTIC

Ref

PVPR

APLIQUE LED SOLAR PARED 2 DIRECCIONES

IP65

3200K/5000K



APQ-072

24,54€



IP 65

100 Lm



Ángulo de luz AJUSTABLE



DUAL COLOR



3200K
5000K



BATERÍA: 3.7V 1500mAh

SERIE PLASTIC

Ref

PVPR

LÁMPARA LED SOLAR PARED 5000K

IP65

5000K



APQ-073

12,90€



IP 65

150 Lm



SENSOR MOVIMIENTO



SOLAR VINTAGE



BATERÍA: 3.7V 2000mAh - 2 FORMAS DE COLOCACIÓN (PARED - SUELO)

Ref PVPR

APLIQUE LED SOLAR PARED PIRAMIDE NEGRO

IP65

5000K

APQ-074

59,40€



IP 44

100 Lm



SERIE ALUMINIO



PANEL-VIDRIO



BATERÍA: 3.7V 1500mAh

SERIE PLASTIC

Ref PVPR

APLIQUE LED SOLAR PARED PIRAMIDE NEGRO

IP65

5000K

APQ-075

11,28€



IP 65

250 Lm

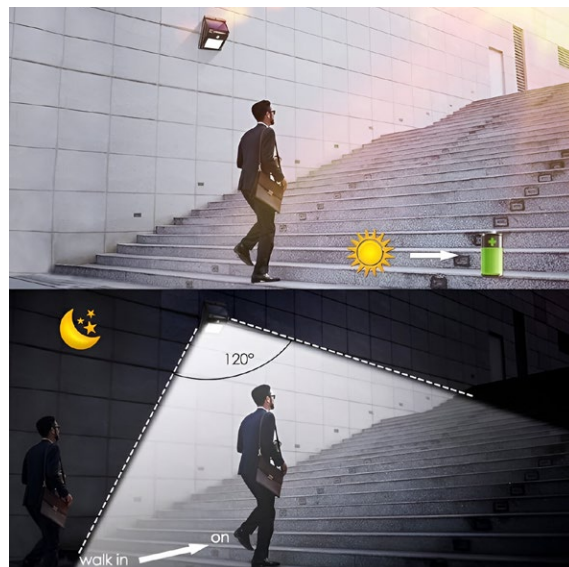



BATERIA
LiFePO4 10Ah
LARGA DURACIÓN
CLASE A

- CARGA SOLAR
- CONTROL INTELIGENTE DE LUZ
- RESISTENTE AL AGUA IP65
- SENSOR PIR DE MOVIMIENTO

FAROLA LED SOLAR 50MM DIAM C/MANDO		1100Lm LED IP65	K	Ref	PVPR
			5000K	FRL-046	154,71€

- 1100 Lm
- 1
- IP 65
- 360°
- SENSOR PIR MOVIMIENTO**
- SENSOR CREPUSCULAR**

Disponible control remoto



BATERIA
LiFePO4 18Ah
LARGA DURACIÓN
CLASE A

FAROLA LED SOLAR 50MM DIAM C/MANDO		2100Lm LED IP65	K	Ref	PVPR
			5000K	FRL-047	225,60€

- 2100 Lm
- 1
- IP 65
- 360°
- SENSOR PIR MOVIMIENTO**
- SENSOR CREPUSCULAR**

Disponible control remoto



SOPORTE PARA FAROLA SOLAR FRL-046/047		NEGRO	Ref	PVPR
			ACLED-492	15,54€



Lit by
LUMILEDS

SERIE ALUMINIO

		K°	Ref	PVPR
FAROLA LED SOLAR 48MM DIAM C/MANDO	1800Lm LED IP65	3200K	FRL-056	185,40€
FAROLA LED SOLAR 48MM DIAM C/MANDO	1800Lm LED IP65	4200K	FRL-048	185,40€
FAROLA LED SOLAR 48MM DIAM C/MANDO	1800Lm LED IP65	5000K	FRL-049	185,40€

1800 Lm

1

IP 65

150°

SENSOR PIR MOVIMIENTO



SENSOR CREPUSCULAR

Disponible control remoto



Lit by
LUMILEDS

SERIE ALUMINIO

		K°	Ref	PVPR
FAROLA LED SOLAR 48MM DIAM C/MANDO	2600Lm LED IP65	3200K	FRL-057	224,55€
FAROLA LED SOLAR 48MM DIAM C/MANDO	2600Lm LED IP65	4200K	FRL-050	224,55€
FAROLA LED SOLAR 48MM DIAM C/MANDO	2600Lm LED IP65	5000K	FRL-051	224,55€

2600 Lm

1

IP 65

150°

SENSOR PIR MOVIMIENTO



SENSOR CREPUSCULAR

Disponible control remoto



Lit by
LUMILEDS

SERIE ALUMINIO

		K°	Ref	PVPR
FAROLA LED SOLAR 48MM DIAM C/MANDO	3400Lm LED IP65	3200K	FRL-058	289,08€
FAROLA LED SOLAR 48MM DIAM C/MANDO	3400Lm LED IP65	4200K	FRL-052	289,08€
FAROLA LED SOLAR 48MM DIAM C/MANDO	3400Lm LED IP65	5000K	FRL-053	289,08€

3400 Lm

1

IP 65

150°

SENSOR PIR MOVIMIENTO



SENSOR CREPUSCULAR

Disponible control remoto



Ø BASE 48mm

		Ref	PVPR
SOPORTE PARA FAROLA SOLAR FRL-048/053	GRIS	ACLED-493	

Disponible control remoto



BATERIA LiFeP04 3.2V 20Ah
LARGA DURACION CLASE A

NEW FAROLA UFO

NUEVO DISEÑO | NUEVA BATERÍA

- BATERÍA MEJORADA
- MEJORA ESTÉTICA
- ALTA LUMINOSIDAD
- MAYOR AUTONOMÍA

Ø BASE 50mm - SENSOR DE MOVIMIENTO Y CREPUSCULAR

		Kº	Ref	PVPR
FAROLA LED SOLAR 50MM DIAM C/MANDO	1800Lm LED IP65	4500K	FRL-054	215,70€
FAROLA LED SOLAR 50MM DIAM C/MANDO	1800Lm LED IP65	5000K	FRL-055	215,70€

1800 Lm

1

IP 65

360º

SENSOR PIR MOVIMIENTO



TEMPORIZADOR



CONTROL DE LUZ INTELIGENTE



MANDO A DISTANCIA



SENSOR DE MOVIMIENTO PIR



Tiras de Led



TIRA LED COB 5W/M



TIRA LED COB *5w/m IP20* **3200K** **Ref** TLED-134 **PVPR** 55,92€

5 w/m 480 Lm/m 24V 1 120° IP 20 5 M **SLIM 4mm MUEBLES**



5m

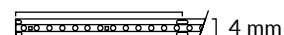

TIRA LED COB 12W/M IP65



TIRA LED COB *12w/m IP65* **2700K** **Ref** TLED-130 **PVPR** 46,62€

12 w/m 1140 Lm/m 24V 1 120° IP 65 5 M

Adhesivo posterior **3M VHB EXTRA FUERTE**



5m

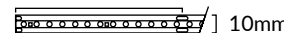

TIRA LED COB *12w/m IP65* **2700K** **Ref** TLED-140 **PVPR** 48,48€

TIRA LED COB *12w/m IP65* **3200K** **Ref** TLED-141 **PVPR** 48,48€

TIRA LED COB *12w/m IP65* **4200K** **Ref** TLED-142 **PVPR** 48,48€

TIRA LED COB *12w/m IP65* **5000K** **Ref** TLED-143 **PVPR** 48,48€

12 w/m 1140 Lm/m 24V 1 120° IP 65 5 M

Protección silicona **BLANCO MATE**
Adhesivo posterior **3M VHB EXTRA FUERTE**

FROSTED



5m

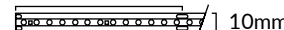

TIRA LED COB *12w/m IP65* **2700K** **Ref** TLED-136 **PVPR** 484,74€

TIRA LED COB *12w/m IP65* **3200K** **Ref** TLED-137 **PVPR** 484,74€

TIRA LED COB *12w/m IP65* **4200K** **Ref** TLED-138 **PVPR** 484,74€

TIRA LED COB *12w/m IP65* **5000K** **Ref** TLED-139 **PVPR** 484,74€

12 w/m 1140 Lm/m 24V 1 120° IP 65 50 M

Protección silicona **BLANCO MATE**
Adhesivo posterior **3M VHB EXTRA FUERTE**

FROSTED



50m

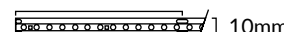

TIRA LED COB *12w/m IP65* **3200K** **Ref** TLED-131 **PVPR** 533,22€

TIRA LED COB *12w/m IP65* **4200K** **Ref** TLED-132 **PVPR** 533,22€

TIRA LED COB *12w/m IP65* **5000K** **Ref** TLED-133 **PVPR** 533,22€

12 w/m 1140 Lm/m 24V 1 120° IP 65 50 M

Adhesivo posterior **3M VHB EXTRA FUERTE**



50m



CONEXIÓN DIRECTA 230V



TIRA LED COB *12w/m IP65* **2700K** **Ref** TLED-126 **PVPR** 596,64€

TIRA LED COB *12w/m IP65* **3200K** **Ref** TLED-127 **PVPR** 596,64€

TIRA LED COB *12w/m IP65* **4200K** **Ref** TLED-128 **PVPR** 596,64€

TIRA LED COB *12w/m IP65* **5000K** **Ref** TLED-129 **PVPR** 596,64€

12 w/m 960 Lm/m 230V 1 120° IP 65 50 M

Adhesivo posterior **3M VHB EXTRA FUERTE**



50m



ACCESORIOS PARA TLED 126-127-128-129



Ref ACLED - 494
Enchufe
conexión

PVPR 7,08€



ACLED - 495
Cable 1 metro
sin enchufe

8,94€



ACLED - 496
Conector COB
Tira-Tira recto

1,86€



ACLED - 497
Conector COB
Tira-Tira esquina

2,61€



ACLED - 498
Tapa final
12mm

0,36€

ACCESORIOS PARA TLED 136-137-138-139-140-141-142-143



Ref ACLED - 502
Conector Cob
Tira-Cable
300mm

PVPR 4,86€



ACLED - 503
Conector Cob
Tira-Tira recto

1,86€



ACLED - 504
Conector Cob
Tira-Tira esquina

2,61€



ACLED - 505
Conector COB
Tapa final

0,36€



Tiras de Led digital

TIRA LED DIGITAL 10W/M



TIRA LED DIGITAL

10w/m IP65

DIGITAL RGB

TLED-135

PVPR

67,08€

5m Corte cada 10cm

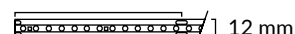

10 w/m

400 Lm/m

24V

1

120°

IP 65

5 M



Adhesivo posterior 3M VHB EXTRA FUERTE



CONTROLADOR LED 8A

RGB/RGBW DIGITAL SPI

CONTR-100

Ref

PVPR

73,32€



Personaliza completamente una gran cantidad de modos de color RGB / RGBW

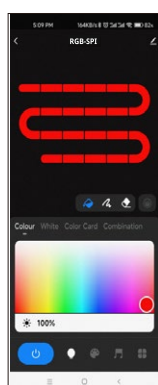

Color

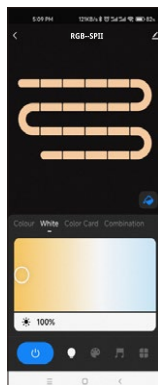

Blanco

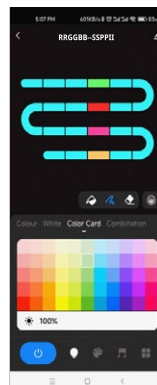

Carta de colores



Combinación



PARA TIRA LED DIGITAL - Pilas CR2032 -

MANDO NEGRO CONTROLADOR RF

RGB / RGBW

Ref

PVPR

CONTR-101

48,24€



ZONA RGB o RGBW



Tira de led Neon Flex



Corte cada 10cm

TIRA LED NEON FLEX 230V

3200K

Ref

PVPR

TLED-122

178,32€



Corte cada 10cm

TIRA LED NEON FLEX 230V

4200K

Ref

PVPR

TLED-123

178,32€



Corte cada 10cm

TIRA LED NEON FLEX 230V

6500K

Ref

PVPR

TLED-124

178,32€



Corte cada 10cm

TIRA LED NEON FLEX 230V

Golden

Ref

PVPR

TLED-125

178,32€



ACCESORIOS

TLED-122/123/124/125



Ref

PVPR

ENCHUFE CONEXIÓN TIRA LED NEON FLEX

ACLED-487

3,48€



TAPA FINAL PARA TIRA LED NEON FLEX

ACLED-488

0,39€



NO DISPONE DE WIFI

PASTILLA PULSADOR CON EFECTO MEMORIA - FUNCIONA PARA VARIOS PULSADORES -

PASTILLA **DIMMABLE TRIAC** POR PULSADOR  **MÁX 360W** CONTR-022 52,62€



CONTR-036 CONTR-056

COMPATIBLE CON MANDO
CONTR-036 Y CONTR-056

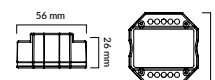

Disponible
para varios
pulsadores



PASTILLA **DIMMABLE TRIAC** WIFI 300W LED **WIFI 300W LED** CONTR-063 60,66€

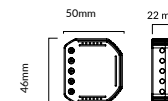

CONTROLADOR **DIMMABLE TRIAC** WIFI PULSADOR **WIFI 500W LED** CONTR-096 84,30€



- CONEXIÓN WIFI, 2,4Ghz, BLUETOOTH
- CONTROL REMOTO 2,4Ghz
- DIMMABLE 0-100% SIN PARPADEO

MANDO CONTROL REMOTO



PARA TLED MONOCOLOR Y DUAL COLOR

PARA CONTR-038 Y CONTR-022

RUEDA TÁCTIL - Pilas x2 AAA

Ref PVPR

MANDO RF 4 ZONAS 3 ESCENAS **MONO / CCT** CONTR-098 64,26€



 **4 ZONAS - 3 ESCENAS**



PARA TLED RGB Y RGBW

PARA CONTR-039

RUEDA TÁCTIL - Pilas x2 AAA

Ref PVPR

MANDO RF 1 ZONAS 2 ESCENAS **RGB / RGBW** CONTR-099 64,26€



 **1 ZONA - 2 ESCENAS**

Domotiza tu vivienda a la mejor **calidad precio** **SENCILLO Y EFICAZ**



Algunos de nuestros productos son
Compatibles con los principales asistentes de voz
(asistente de Google*, Amazon*, Alexa* ... etc.)”v

Estas marcas son propiedad de sus respectivos propietarios,
y como tal, son reconocidas por Atmoss Electric Equipment S.L
y son utilizadas únicamente con fines enunciativos.

App
tuya

HAZ TU VIDA MÁS FÁCIL Y SEGURA

DOMOTIZA TODO TU HOGAR CON PRODUCTOS DE ATMOS

Seguridad



Persianas



Enchufes



Iluminación



Puerta garaje



Domótica



Tuya Smart es la **aplicación más utilizada** en el sector del hogar inteligente.

Su funcionamiento está basado en la gestión de dispositivos inteligentes, proporcionando un control total y remoto, además de configurar escenarios predeterminados que aumentan la usabilidad y calidad de la APP.

SEGURIDAD

Se trata de la configuración de una red de seguridad compuesta por **alarmas, detectores, cerradura inteligente, cámaras...** Permite controlar cualquier tipo de intrusión mediante cámaras de vigilancia o alarmas personales.

PERSIANAS

Controla tu persiana mediante smartphone, mando, pulsador,...

ENCHUFES

La mejor forma de **controlar el encendido y apagado de dispositivos** conectados a la electricidad. Puede monitorizar el **ahorro de energía**, proteger contra sobretensiones, desconectar la alimentación de la red eléctrica **mediante tu smartphone**.

PUERTA GARAJE

Automatiza tu puerta del garaje, abre tu puerta sin necesidad de bajar del vehículo.

ILUMINACIÓN

Crea diferentes ambientes con nuestras lámparas WiFi. Controla el encendido o apagado, la regulación o el color desde la App.

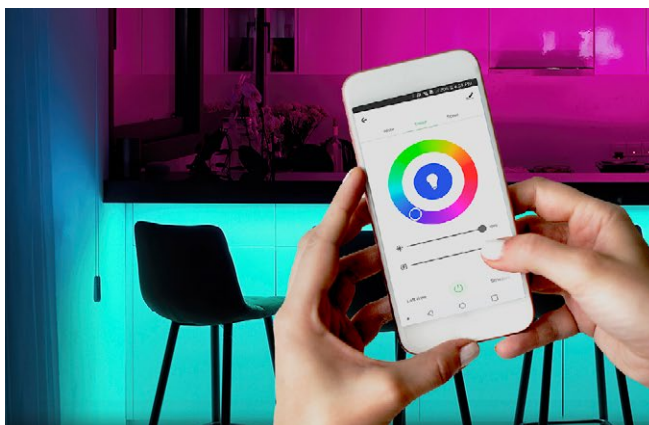

VENTAJAS

- Ayuda para personas con movilidad reducida.
- Ahorro energético.
- Mejor confort.
- Fácil instalación.
- Domotiza tu vivienda a un precio reducido.
- Amplía la cobertura WiFi en tu vivienda.

NUEVA CÁMARA

4.0MP
MEGAPIXEL



IP66

COMPATIBLE
CON APP **tuya**

CAM-009



ALTA RESOLUCIÓN

2K
QUADHD

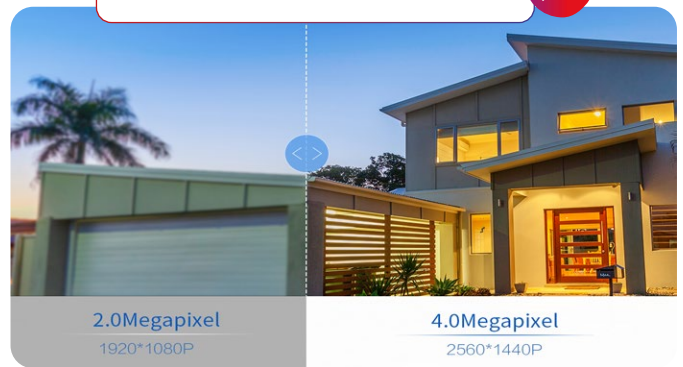

2K - BLANCA - VISIÓN NOCTURNA EN COLOR - MOTORIZADA

	Ref	PVPR
CAMARA WIFI VIGILANCIA 2K 4MP IP66	CAM-009	119,70€

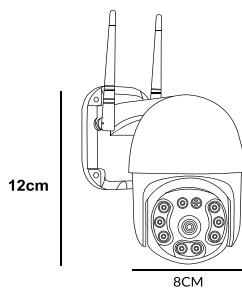



Control de acceso



	Ref	PVPR
TECLADO CONTROL NUMÉRICO ACCESO PUERTA APP TUYA	SGR-041	104,85€



- Admite 2000 usuarios
- Velocidad de funcionamiento rápida, <20ms con 2000 usuarios
- Admite tarjeta, PIN, tarjeta+PIN
- Teclas retroiluminadas
- Tiempo de apertura de puerta ajustables
- Protección contra cortocircuitos
- Fácil de instalar y programar



	Ref	PVPR
FUENTE DE ALIMENTACIÓN 12V	SGR-042	48,45€



	Ref	PVPR
TIMBRE 12V ABS SONIDO DING DONG BLANCO	TIMB-399	18,30€



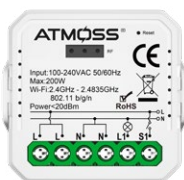

Compatible con CONTR-105

Ref PVPR

PASTILLA REGULACIÓN TRIAC WIFI RF UART HOLE

CONTR-104 58,50€



Sensores



SENSOR PRESENCIA

Altura de instalación: 2,5m - 4m

Señal de movimiento máxima de 4-5m (radio) (Movimiento de la mano, movimiento de la cabeza)
Señal de respiración de 2-3 m (radio).- 12min

SENSOR DE PRESENCIA EMPOTRADO **360° 400W LED IP65** Ref ACLED-485 PVPR 79,86€

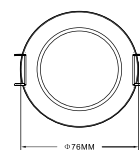
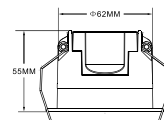

Altura de instalación 2 - 2,5m

Distancia de DETECCIÓN REGULABLE 1,2 - 4,6m

SENSOR DE PRESENCIA SUPERFICIE **360° 1000W LED IP65** Ref ACLED-486 PVPR 63,42€



Altura de instalación 2 - 2,5m

Distancia de DETECCIÓN REGULABLE 1,2,4,6m

Lux regulable 10/30/100 lux

10 seg - 15min

SENSOR DE PRESENCIA SUPERFICIE/EMPOTRADO **360° 400W LED IP20** Ref ACLED-491 PVPR 77,46€



Altura de instalación 1 - 1,8m

Distancia de DETECCIÓN 9m

SENSOR DE MOVIMIENTO INFRARROJO PARED EMPOTRADO **160° 200W LED IP20** Ref ACLED-482 PVPR 26,76€



Altura de instalación 1,8 - 4m

Distancia de DETECCIÓN 8m

SENSOR DE MOVIMIENTO INFRARROJO EMPOTRADO **360° 600W LED IP65** Ref ACLED-470 PVPR 17,07€

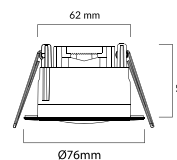



Altura de instalación 1,8 - 2,5m
 Distancia de DETECCIÓN 12m

		Ref	PVPR
SENSOR DE MOVIMIENTO INFRARROJO SUPERFICIE	180°/360° 600W LED IP65	ACLED-471	25,62€



Altura de instalación 1,8 - 2,5m
 Distancia de DETECCIÓN 12m

		Ref	PVPR
SENSOR DE MOVIMIENTO INFRARROJO EXTERIOR SUPERFICIE	180-360° 300W LED IP65	ACLED-483	24,66€



Altura de instalación: 1,8 - 2,5mts
 Distancia detección Ø12mts

		Ref	PVPR
SENSOR DE MOVIMIENTO INFRARROJO	180° 300W LED IP44	ACLED-479	14,10€

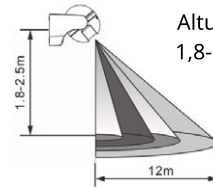

Altura de instalación:
 1,8-2,5m



Altura de instalación:
 Montaje en pared de 1,8 a 2,5 m
 Montaje en techo de 2,2-4 m
 Velocidad de movimiento de detección: 0,6-1,5 m/s
SENSOR 3 EN 1 PARED / TECHO / ESQUINA

		Ref	PVPR
SENSOR DE MOVIMIENTO INFRARROJO SUPERFICIE	180-360° 1000W LED IP54	ACLED-481	35,22€

INFORMACIÓN DEL SENSOR:

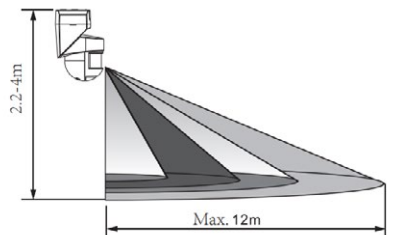
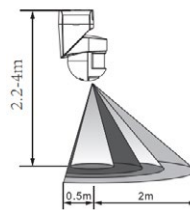
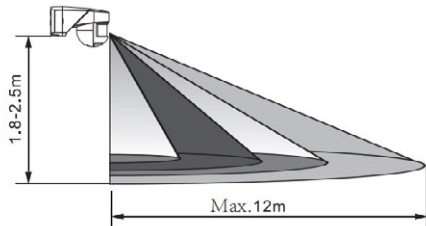
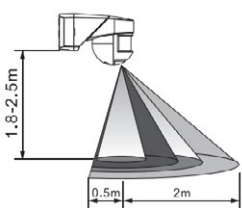



Sensor caja estanco



Altura de instalación 1 - 1,8m
Distancia de DETECCIÓN 10m

	Ref	PVPR
SENSOR DE MOVIMIENTO ESTANCO 190° 500W LED IP65	ACLED-478	31,65€



INCLUYE MANDO

Altura de instalación 1 - 1,8m
Distancia de DETECCIÓN 10m

	Ref	PVPR
SENSOR DE MOVIMIENTO INFRARROJO CAJA ESTANCA 180-360° 1000W LED IP65	ACLED-484	42,30€



Altura de instalación 2,2 - 4m
Distancia de DETECCIÓN 8m

	Ref	PVPR
SENSOR DE MOVIMIENTO INFRARROJO SUPERFICIE/EMPOTRAR 360° 600W LED IP20	ACLED-472	18,84€



Altura de instalación: 2,2 - 4mts
Distancia detección Ø8mts

	Ref	PVPR
SENSOR DE MOVIMIENTO INFRARROJO EMPOTRADO 360° 300W LED IP20	ACLED-480	19,02€

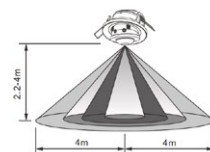

Altura de instalación:
2,2 - 4mts



Sensor de mano



Distancia de DETECCIÓN 5-6cm

SENSOR DE ON/OFF MOVIMIENTO MANO 360° 500W LED IP20

Ref	PVPR
ACLED-473	17,43€



ON/OFF
SENSOR DE
MOVIMIENTO
MANO



Sensor de puerta



Distancia de DETECCIÓN 5-6cm

SENSOR DE ON/OFF MOVIMIENTO PUERTA 360° 500W LED IP20

Ref	PVPR
ACLED-474	17,43€



ON/OFF
SENSOR DE
MOVIMIENTO
PUERTA



Sensor de escalera

CONTROLADORES SENSOR DE ESCALERA

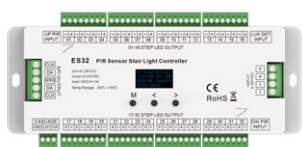

CONTROLADOR LUZ ESCALERA CON SENSOR PIR

Ref	PVPR
CONTR-102	283,20€



32 CANALES / 1A (CANAL)



Incluye:

- PIR Sensor 2Ud (1,2mts)
- Sensor de luz diurna
- Cable sensor PIR (5mts)
- Número de luces de escalera ajustable, máx. 32 peldaños
- 8 velocidades de iluminación graduadas ajustables
- 4 modos de iluminación de trabajo opcionales
- Dos controladores de luz de escalera pueden funcionar en cascada
- Control de interruptor pulsador opcional



CABEZAL SENSOR DE MOVIMIENTO PIR

Ref	PVPR
CONTR-103	26,82€

Dynamic ART S40

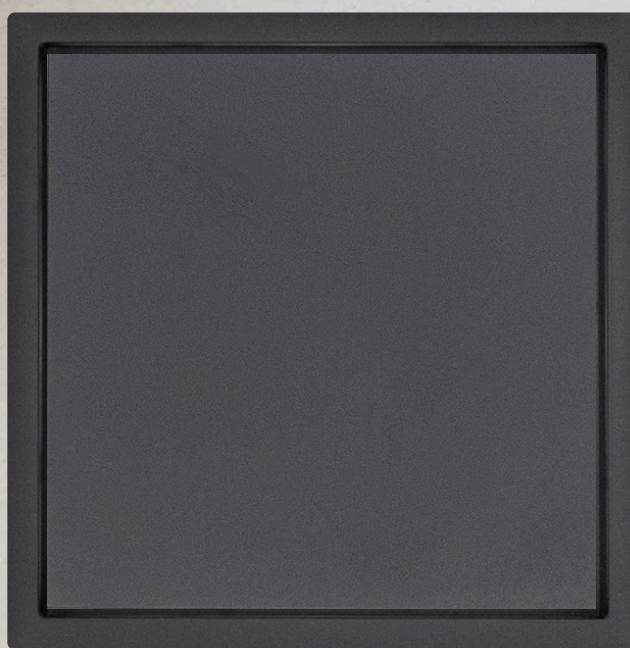



Dynamic Art



	Ref	PVPR
TAPA BASE 16A USB TIPO A,C/ BLANCO S40 ART	S40.408.10	2,92€



	Ref	PVPR
TAPA BASE 16A USB TIPO A,C/ ALUMINIO S40 ART	S40.408.11	4,28€



	Ref	PVPR
TAPA BASE 16A USB TIPO A,C/ NEGRO S40 ART	S40.408.17	4,28€



	Ref	PVPR
TECLA PULSADOR ESCALERA CON LED BLANCO S40 ART	S40.409.10	1,84€



	Ref	PVPR
TECLA PULSADOR ESCALERA CON LED ALUMINIO S40 ART	S40.409.11	2,84€



	Ref	PVPR
TECLA PULSADOR ESCALERA CON LED NEGRO S40 ART	S40.409.17	2,84€



	Ref	PVPR
TAPA SALIDA CABLE/BLANCO MATE S40 ART	S40.419.18	1,28€



Interruptor tarjeta



8800 W - TIEMPO 20s - Válido para cajas universales

		REF	PVPR
INTERRUPTOR DE TARJETA	Blanco	SGR-044	11,88€
INTERRUPTOR DE TARJETA	Negro	SGR-045	11,88€



ATMOSS
ELECTRIC

Aparamenta y accesorios



MATERIAL
ELÉCTRICO

AHORRA ESPACIO, hasta un 50% más en tú instalación
con los nuevos modelos de espacio reducido

EJEMPLO DE INSTALACIÓN DE VIVIENDA DE 50 A 20CM

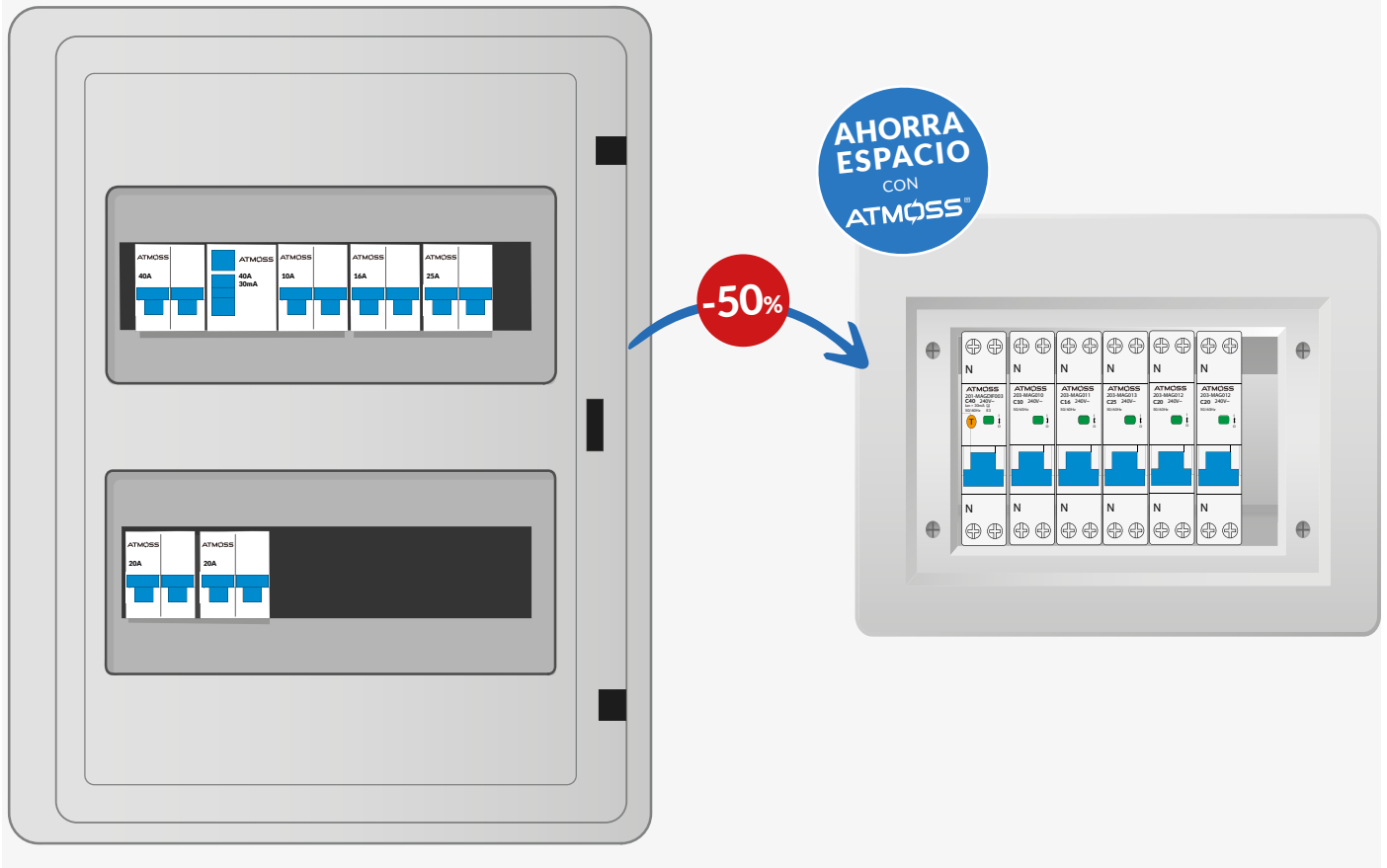

Ejemplo de instalación de vivienda:



MAGNETOTÉRMICO GENERAL
2P 40A - 6kA - Curva C
200-MAG028



Magnetotérmico general + Diferencial
1P+N 40A - 6kA 30mA
Curva C
201-MAGDIF003



DIFERENCIAL
2P 40A - 6kA - TIPO AC
200-DIF011

PEQUEÑO INTERRUPTOR AUTOMÁTICO PIAS



- 200-MAG023 -10A
- 200-MAG024 -16A
- 200-MAG026 -25A
- 200-MAG025 -20A



- 203-MAG010 -10A
- 203-MAG011 -16A
- 203-MAG013 -25A
- 203-MAG012 -20A



Diferencial 2P - 10kA - Tipo AC 

2P - 10kA - 30mA - 63A

REF		PVPR
100-DIF005	63A 10kA 30mA	43,86 €



4 POLOS - 10kA - TIPO AC   1 UDS

REF		PVPR
101-DIF00003	63A 10kA 300mA	57,93 €

Evita los cortes intempestivos 
MAYOR SENSIBILIDAD



Diferencial Superinmunizados

4 POLOS - 10kA - TIPO A   1 UDS

REF		PVPR
100-DIF015	63A 10kA 300mA	67,98 €
100-DIF022	100A 10kA 300mA	81,78 €

SERIES COMBI VIGI

SERIE COMBI

**2POLOS EN
1 MÓDULO**

Magneto Diferencial Superinmunizado Tipo A 

REF		PVPR
301-MGDIF000	10A 6kA 10mA	62,55 €

IP+N - 6kA 30mA - Curva C

301-MGDIF001	10A 6kA	62,55 €
301-MGDIF002	16A 6kA	62,55 €
301-MGDIF003	20A 6kA	62,55 €
301-MGDIF004	25A 6kA	62,55 €
301-MGDIF005	32A 6kA	62,55 €
301-MGDIF006	40A 6kA	62,55 €

IP+N - 6kA 300mA - Curva C

301-MGDIF008	16A 6kA	62,55 €
301-MGDIF012	40A 6kA	62,55 €





INTERRUPTOR HORARIO DIGITAL

Compatible con pila CR2032
Módulo estrecho 1 módulo

Programa tus dispositivos eléctricos con facilidad.

Es adecuado para uso particular de las siguientes tareas:

- Iluminación de áreas privadas e industriales,
- Iluminación de calles y escaparates
- Regulación de aire acondicionado
- Motores, bombas, plantas y maquinaria, así como para simular presencia, etc.

- Interruptor de disparo externo
- Programa de cuenta atrás (1s~59m59s)
- Programa diario y semanal.
- 32 programas de pulso (1s~59m59s)
- Fecha y hora preestablecidas
- 16 grupos de programa ON/OFF
- Mostrar año/mes/día/hora/minuto
- Encendido/Apagado permanente
- Totalmente operable sin conexión a la red eléctrica
- Reemplazo de batería de litio y batería recargable

	REF		PVPR	
INTERRUPTOR HORARIO DIGITAL	RLJ-013	16A 230V IP20	55,50€	↓

Cintas eléctricas

USO PROFESIONAL



20m
x19mm (Ancho)
0,15mm Grosor



CINTAS ELÉCTRICAS DE PRIMERA CALIDAD PARA AISLAMIENTO ELÉCTRICO

Norma: EN 60454-3-12:2006 NORMA CE 2014/35/EU



CARACTERÍSTICAS

- Alta flexibilidad.
- Alta resistencia a la rotura.
- Alta recuperación de elasticidad
- Ignífugo
- Buena protección mecánica y eléctrica
- Aislamiento de hilos y cables eléctricos hasta 600v, 80°C
- Espesor 0,15mm
- Composición, cinta de PVC con adhesivo de caucho

DESCARGAR 
FICHA TÉCNICA

Medidas  19mm  0,15mm
20m 19mm



SE VENDE EN PAQUETE DE 10UDS - PRECIO UNITARIO

 10 UDS

Ref

PVPR

CINTA AISLANTE PVC IGNÍFUGO

NEGRO

CIN-001

1,44€



SE VENDE EN PAQUETE DE 10UDS - PRECIO UNITARIO

 10 UDS

Ref

PVPR

CINTA AISLANTE PVC IGNÍFUGO

AZUL

CIN-002

1,44€

NUEVOS PRODUCTOS

ATMOSS[®]
LIGHTING



SE VENDE EN PAQUETE DE 10UDS - PRECIO UNITARIO

10 UDS

Ref

PVPR

CINTA AISLANTE PVC IGNÍFUGO

AMARILLO-VERDE

CIN-003

1,44€



SE VENDE EN PAQUETE DE 10UDS - PRECIO UNITARIO

10 UDS

Ref

PVPR

CINTA AISLANTE PVC IGNÍFUGO

BLANCO

CIN-004

1,44€



SE VENDE EN PAQUETE DE 10UDS - PRECIO UNITARIO

10 UDS

Ref

PVPR

CINTA AISLANTE PVC IGNÍFUGO

VERDE

CIN-005

1,44€



SE VENDE EN PAQUETE DE 10UDS - PRECIO UNITARIO

10 UDS

Ref

PVPR

CINTA AISLANTE PVC IGNÍFUGO

GRIS

CIN-006

1,44€



SE VENDE EN PAQUETE DE 10UDS - PRECIO UNITARIO

10 UDS

Ref

PVPR

CINTA AISLANTE PVC IGNÍFUGO

ROJO

CIN-007

1,44€



SE VENDE EN PAQUETE DE 10UDS - PRECIO UNITARIO

10 UDS

Ref

PVPR

CINTA AISLANTE PVC IGNÍFUGO

AMARILLO

CIN-008

1,44€



Reloj temporizador

NEW!



Reloj temporizador digital

RLJ-011

Reloj temporizador semanal digital

PVPR 28,59 €

 1 UDS

DESCARGAR 
VIDEO

NEW!



Reloj temporizador exterior IP44

RLJ-012

Reloj temporizador mecánico blanco exterior

PVPR 19,74 €

 1 UDS



NEW!



Reloj temporizador

RLJ-010

Reloj temporizador mecánico mini blanco

PVPR 14,22 €

 1 UDS



Portalámpara E27



PORTALÁMPARA E27	BLANCO	PORTLM-004	0,78€
PORTALÁMPARA E27	NEGRO	PORTLM-005	0,78€



Timbres



				Ref	PVPR
TIMBRE BUZZER	30W	220V-240V	SONIDO ZUMBADOR	TIMB-004	5,55€





ATMOSS[®]

LIGHTING



Atmoss Electric Equipment, S.L.
Calle los Mecánicos, 5 03130
Pol. Ind. Santa Pola (Alicante) España

Tel. +34 966 693 404 / +34 865 66 48 50

www.atmoss.es