



ATMOSS[®]



 Mecanismos

 Material eléctrico

 Domótica

CATÁLOGO
MECANISMOS, MATERIAL
ELÉCTRICO, DOMÓTICA
2024-2025

ATMOSS[®]

LIGHTING

Nos ubicamos en el Polígono de Santa Pola, ocupando un espacio de 6000m² distribuidos en 10 naves industriales. Estas modernas instalaciones destacan por su amplitud y luminosidad, creando un entorno propicio para la eficiencia operativa.

Cada una de las 10 naves ha sido diseñada con precisión para optimizar el almacenamiento y la gestión logística. Este extenso espacio nos permite mantener **más de 2000 referencias en stock**, garantizando una oferta diversificada y una respuesta ágil a las necesidades del mercado.

La iluminación en nuestras instalaciones ha sido cuidadosamente planificada para asegurar una visibilidad óptima, contribuyendo a un ambiente de trabajo cómodo y productivo. En Atmoss Electric, nuestras instalaciones no solo reflejan modernidad y eficiencia, sino que también respaldan nuestro compromiso con la excelencia y la disponibilidad inmediata de productos para nuestros clientes.



NUESTRAS *INSTALACIONES*

ALMACÉN

6000m² repartidos en más de 10 naves, con más de 2000 referencias en stock.





Tuya Smart es la **aplicación más utilizada** en el sector del hogar inteligente. Su funcionamiento está basado en la gestión de dispositivos inteligentes, proporcionando un control total y remoto, además de configurar escenarios predeterminados que aumentan la usabilidad y calidad de la APP.

SEGURIDAD

Se trata de la configuración de una red de seguridad compuesta por **alarmas, detectores, cerradura inteligente, cámaras...** Permite controlar cualquier tipo de intrusión mediante cámaras de vigilancia o alarmas personales.

PERSIANAS

Controla tu persiana mediante smartphone, mando, pulsador,...

ENCHUFES

La mejor forma de **controlar el encendido y apagado de dispositivos** conectados a la electricidad. Puede monitorizar el **ahorro de energía**, proteger contra sobretensiones, desconectar la alimentación de la red eléctrica **mediante tu smartphone**.

PUERTA GARAJE

Automatiza tu puerta del garaje, abre tu puerta sin necesidad de bajar del vehículo.

ILUMINACIÓN

Crea diferentes ambientes con nuestras lámparas WiFi. Controla el encendido o apagado, la regulación o el color desde la App.

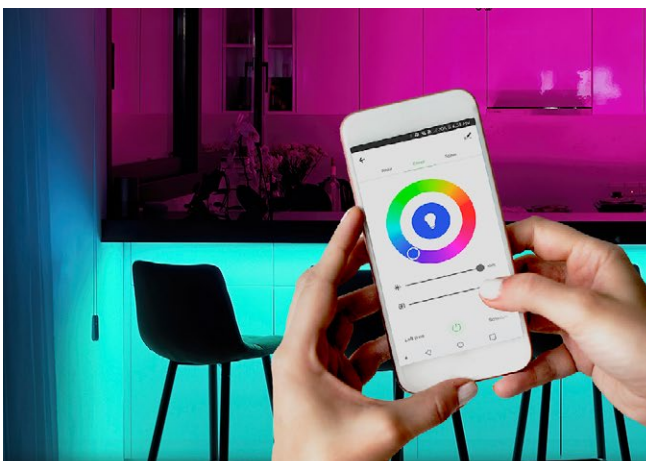

VENTAJAS

- Ayuda para personas con movilidad reducida.
- Ahorro energético.
- Mejor confort.
- Fácil instalación.
- Domotiza tu vivienda a un precio reducido.
- Amplía la cobertura WiFi en tu vivienda.

Índice

Mecanismos

- 6 Dynamic S20
- 12 Dynamic Plus S30
- 18 Dynamic Art S40
- 26 Dynamic S55
- 32 Dynamic MAT65
- 34 Interruptor táctil temporizador

La gama de mecanismos tiene un descuento diferente a la sección de:

- *Pequeño material eléctrico*
- *Aparamenta eléctrica*
- *Domótica*

DESCARGA EL CATÁLOGO DE NOVEDADES
PARA ESTAR SIEMPRE ACTUALIZADO



Pequeño material eléctrico

- 36 Pequeño material eléctrico

Aparamenta eléctrica

- 46 Aparamenta eléctrica

Domótica

- 72 Domótica

NUEVO CATÁLOGO DE ILUMINACIÓN

DESCARGAR CATÁLOGO





Tecla.10 + Marco.10

Blanco.10



Tecla.10 + Marco.11

Aluminio.11



Tecla.11 + Marco.12

Antracita.12



Tecla.10 + Marco.20

Perla brushed .20

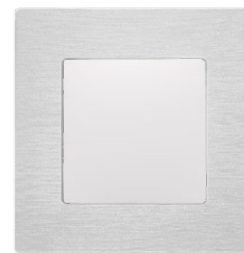

Tecla.10 + Marco.21

Aluminio brushed .21

COMPATIBLE

SERIE COLOR ANTRACITA S20

TODOS NUESTROS MECANISMOS S20 SON COMPATIBLES CON LAS TECLAS S30 ANTRACITA



S20.900.XX - Garra para mecanismo S20/S30



S20.901.XX - Piloto luminoso LED



NEW!

S20.130.10 - Tapa base doble RJ45 Blanco

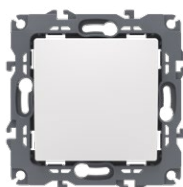

S20.101.XX - Interruptor
S20.102.XX - Conmutador
S20.107.XX - Cruzamiento
S20.109.XX - Pulsador



S20.103.XX - Interruptor luminoso LED
S20.110.XX - Pulsador luminoso LED
S20.122.XX - Conmutador luminoso LED
S20.124.XX - Cruzamiento luminoso LED

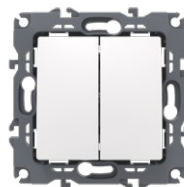

S20.104.XX - Interruptor doble
S20.105.XX - Conmutador doble
S20.136.10 - Cruzamiento doble blanco

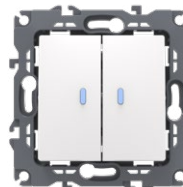

S20.106.XX - Interruptor doble luminoso
S20.123.XX - Conmutador doble luminoso

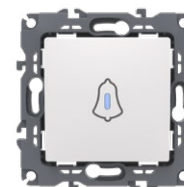

S20.108.XX - Pulsador luminoso timbre led

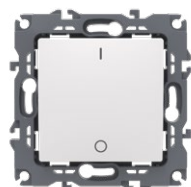

S20.111.XX - Interruptor bipolar



S20.120.XX - Interruptor de persianas
S20.134.10 - Pulsador doble para persiana

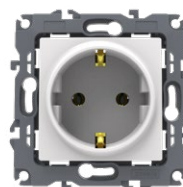

S20.112.XX - Base corriente Schuko 16A
8 UDS
80 UDS
PROTECCIÓN INFANTIL

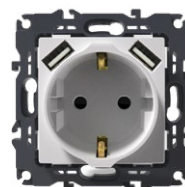

S20.114.XX - Base corriente Schuko 16A + 2 Base USB 2.1A
6 UDS
60 UDS
PROTECCIÓN INFANTIL



NEW! CARGA RÁPIDA
S20.129.10 - Base corriente 16A + 2 USB Tipo A y C
6 UDS
60 UDS
PROTECCIÓN INFANTIL



S20.113.XX - Base doble USB 2.1A
6 UDS
60 UDS



S20.115.XX - Base teléfono RJ11 (CAT3)



S20.116.XX - Base red RJ45 (CAT6)

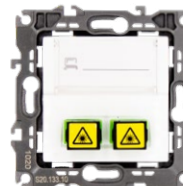

S20.133.XX - Base doble fibra óptica

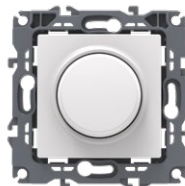

S20.117.XX - Regulador giratorio



S20.118.XX - Tapa ciega



S20.121.XX - Tapa Universal TV + FM + SAT



S20.126.XX - Pulsador con símbolo luz



S20.127.XX - Pulsador con símbolo timbre



S20.128.XX - Pulsador luminoso con símbolo luz



S20.131.XX - Salida cables mecanismo



S20.132.XX - Timbre zumbador



S20.135.10 - Interruptor de tarjeta

Marco **BLANCO.10**

S20.301.10



20 UDS
200 UDS

S20.302.10

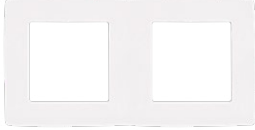

10 UDS
100 UDS

S20.303.10



15 UDS
150 UDS

S20.304.10



10 UDS
100 UDS

Marco **ALUMINIO.11**

S20.301.11



20 UDS
200 UDS

S20.302.11



10 UDS
100 UDS

S20.303.11



15 UDS
150 UDS

S20.304.11



10 UDS
100 UDS

Marco **ANTRACITA.12**

S20.301.12



20 UDS
200 UDS

S20.302.12

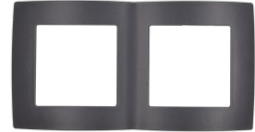

10 UDS
100 UDS

S20.303.12



15 UDS
150 UDS

S20.304.12



10 UDS
100 UDS

Marco **PERLA BRUSHED.20**

S20.301.20



20 UDS
200 UDS

S20.302.20

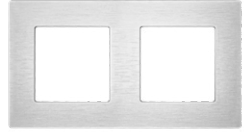

10 UDS
100 UDS

S20.303.20



15 UDS
150 UDS

S20.304.20

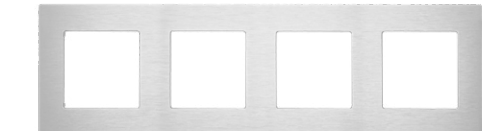

10 UDS
100 UDS

Marco **ALUMINIO BRUSHED.21**

S20.301.21



20 UDS
200 UDS

S20.302.21



10 UDS
100 UDS

S20.303.21



15 UDS
150 UDS

S20.304.21



10 UDS
100 UDS

Dynamic **S20** SUPERFICIE



S20.201.10 ZOCALO SUPERFICIE 1 ELEMENTO/BLANCO S20 PVPR - 4,96€

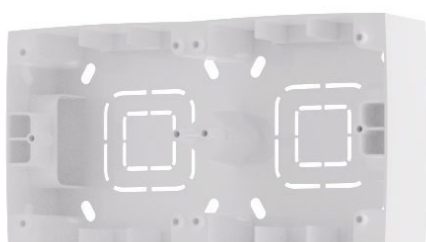

S20.202.10 ZOCALO SUPERFICIE 2 ELEMENTO/BLANCO S20 PVPR - 8 €

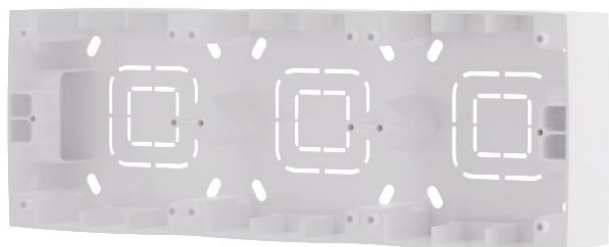



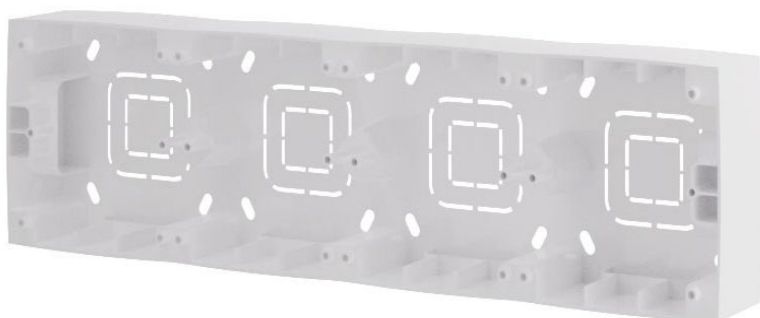







S20.203.10 ZOCALO SUPERFICIE 3 ELEMENTO/BLANCO S20 PVPR - 11,60 €



S20.204.10 ZOCALO SUPERFICIE 4 ELEMENTO/BLANCO S20 PVPR - 15,84 €

Dynamic S20

Nueva serie de mecanismos **Dynamic S20** fabricados en policarbonato ignífugo, con sistema de conexión rápida y fijación por módulos. Varios colores disponibles y posibilidad de combinar teclas y marcos.

DESCRIPCIÓN		MECANISMO / TECLA-TAPA	.10	.11	TECLA-TAPA ANTRACITA S30	.12
	· Interruptor	S20.101.XX	3,92€	4,92€	S30.601.12	1,48€
	· Conmutador	S20.102.XX	5,68€	6,68€	S30.601.12	1,48€
	· Interruptor bipolar	S20.111.XX	6,60€	7,72€	S30.611.12	1,64€
	· Pulsador	S20.109.XX	4,24€	5,20€	S30.609.12	1,48€
	· Cruzamiento	S20.107.XX	8,56€	9,80€	S30.607.12	1,56€
	· Pulsador con símbolo luz	S20.126.XX	5,12€	5,88€	S30.628.12	1,64€
	· Pulsador con símbolo timbre	S20.127.XX	4,24€	5,32€	S30.629.12	1,64€
	· Interruptor doble	S20.104.XX	5,80€	7,32€	S30.604.12	2,08€
	· Conmutador doble	S20.105.XX	9,36€	10,88€	S30.604.12	2,08€
	· Cruzamiento doble	S20.136.10	12,88€			
	· Interruptor de persianas	S20.120.XX	8,28€	9,56€	S30.620.12	1,64€
	· Pulsador doble para persiana	S20.134.10	7,52€		S30.620.12	1,64€
	· Interruptor luminoso LED	S20.103.XX	6,40€	7,48€	S30.603.12	1,60€
	· Conmutador luminoso LED	S20.122.XX	8,04€	9,44€	S30.603.12	1,60€
	· Pulsador luminoso LED	S20.110.XX	6,76€	8,28€	S30.610.12	1,60€
	· Pulsador luminoso timbre LED	S20.108.XX	6,76€	8,28€	S30.608.12	1,60€
	· Cruzamiento luminoso	S20.124.XX	11,16€	12,32€	S30.627.12	1,72€
	· Pulsador luminoso con símbolo luz	S20.128.XX	6,76€	7,84€	S30.630.12	1,72€
	· Interruptor doble luminoso LED	S20.106.XX	10,80€	12,48€	S30.606.12	2,12€
	· Conmutador doble luminoso LED	S20.123.XX	14,28€	16,16€	S30.606.12	2,12€
	· Regulador giratorio 1-10V Máx. 300W LED	S20.117.XX	57,20€	59,96€	S30.617.12	2,64€
	· Base corriente Schuko 16A Con protección infantil Conexión por tornillos	S20.112.XX	5,88€	6,80€	S30.612.12	2,00€
	· Base corriente Schuko 16A 2 puertos USB	S20.114.XX	48,16€	49,24€	S30.614.12	2,24€
	· Base corriente Schuko 16A 2 puertos USB Tipo A y C	S20.129.10	62,48€			
	· Base doble USB 2.1A	S20.113.XX	45,44€	47,36€	S30.613.12	1,56€
	· Base teléfono RJ11 (CAT3)	S20.115.XX	7,28€	8,28€	S30.615.12	1,60€
	· Base red RJ45 (CAT6)	S20.116.XX	12,92€	14,80€	S30.616.12	1,60€
	· Tapa base doble RJ45 Blanco	S20.130.10	8,32€			
	· Tapa Universal TV - FM - SAT	S20.121.XX	2,12€	2,52€	S30.621.12	3,00€
	· Base doble fibra óptica	S20.133.10	11€			
	· Interruptor de tarjeta	S20.135.10	63,16€			
	· Tapa salida de cable sin marco	S20.119.XX	2,88€	4,56€		
	· Salida cables 16A con mecanismo	S20.131.XX	2,88€	4,56€		
	· Tapa ciega	S20.118.XX	1,92€	2,84€		
	· Timbre zumbador	S20.132.XX	21,84€	25€	S30.632.12	1,88€

Marcos disponibles en:

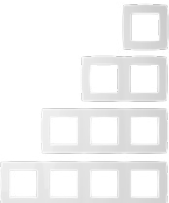
		Blanco.10	Aluminio.11	Antracita.12	Perla brus.20	Aluminio brus.21			
	· Marco 1 elemento	S20.301.XX	1,16€	2,40€	2,60€	3,04€	3,04€	20UDS	200UDS
	· Marco 2 elementos	S20.302.XX	1,68€	3,48€	4,12€	4,36€	4,36€	10UDS	100UDS
	· Marco 3 elementos	S20.303.XX	2,60€	5,60€	6,08€	6,32€	6,32€	15UDS	150UDS
	· Marco 4 elementos	S20.304.XX	4,28€	9,96€	10,44€	10,12€	10,12€	10UDS	100UDS

Precio PVPR

Combinación: Mecanismo con tecla/tapa + Marco (1elemento)

Precio en color:

BLANCO .10 / ALUMINIO .11 / ANTRACITA .12

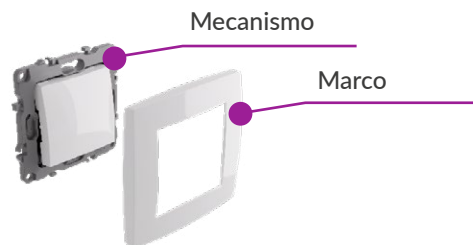

PRODUCTO COMPLETO	.10 BLANCO	.11 ALUMINIO	.12 ANTRACITA
Interruptor Unipolar	5,08€	7,32€	8€
Conmutador	6,84€	9,08€	9,76€
Interruptor bipolar	7,76€	10,12€	10,84€
Pulsador	5,40€	7,60€	8,32€
Cruzamiento	9,72€	12,20€	12,72€
Pulsador con símbolo luz	6,28€	8,28€	9,36€
Pulsador con símbolo timbre	5,40€	7,72€	8,48€
Interruptor doble	6,96€	9,72€	10,48€
Conmutador doble	10,52€	13,28€	14,04€
Interruptor de persianas	9,44€	11,96€	12,52€
Pulsador doble para persiana	8,68€		11,76€
Interruptor luminoso led	7,56€	9,88€	10,60€
Conmutador luminoso led	9,20€	11,84€	12,24€
Pulsador luminoso led	7,92€	10,24€	10,96€
Pulsador luminoso timbre led	7,92€	10,68€	10,96€
Cruzamiento luminoso	12,32€	14,72€	15,48€
Pulsador luminoso con símbolo luz	7,92€	10,24€	11,08€
Interruptor doble luminoso led	11,96€	14,88€	15,52€
Conmutador doble luminoso led	15,44€	18,56€	19€
Regulador giratorio 1-10v	58,36€	62,36€	62,44€
Base corriente schuko 16A	7,04€	9,20€	10,48€
Base corriente schuko 16A 2 puertos USB	49,32€	51,64€	53€
Base corriente schuko 16A 2 puertos USB Tipo A y C	63,64€		
Base doble USB 2.1A	46,60€	49,76€	49,60€
Base teléfono RJ11 CAT3	8,44€	10,68€	11,48€
Base red RJ45 CAT6	14,08€	17,20€	12,12€
Tapa universal TV-FM-SAT	3,28€	4,92€	7,72€
Base doble fibra óptica	12,16€		
Interruptor de tarjeta	64,32€		
Tapa ciega	3,08€	5,24€	
Salida cables 16A	4,04€	6,96€	
Timbre zumbador	23€	27,40€	26,32€



Dynamic PLUS S30

MECANISMOS

 10 UDS

 100 UDS



DESCARGAR
FICHAS TÉCNICAS



Tecla Cerquillo Marco (Aluminio.11) (Aluminio.11) (Blanco.10)



Tecla Cerquillo Marco (Antracita.12) (Antracita.12) (Blanco.10)



Tecla Cerquillo Marco (Aluminio.11) (Grafito.13) (Blanco.10)



Tecla Cerquillo Marco (Aluminio.11) (Grafito.13) (Negro brushed .16)



Tecla Cerquillo Marco (Blanco.10) (Blanco.10) (Blanco.10)

- S30.501.00 - Interruptor
- S30.502.00 - Conmutador
- S30.509.00 - Pulsador
- S30.528.00 - Pulsador símbolo luz
- S30.529.00 - Pulsador símbolo timbre



- S30.503.00 - Interruptor luminoso
- S30.508.00 - Pulsador luminoso timbre
- S30.510.00 - Pulsador luminoso
- S30.522.00 - Conmutador luminoso
- S30.530.00 - Pulsador luminoso símbolo luz
- S30.527.00 - Cruzamiento luminoso led

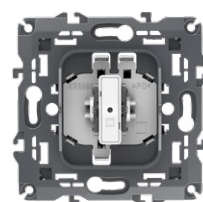

- S30.504.00 - Interruptor doble
- S30.505.00 - Conmutador doble
- S30.507.00 - Cruzamiento
- S30.520.00 - Interruptor de persianas
- S30.534.00 - Pulsador doble para persianas

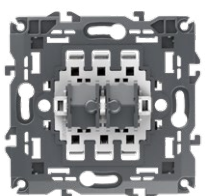

- S30.506.00 - Interruptor doble luminoso
- S30.523.00 - Conmutador doble luminoso

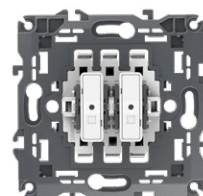

S30.511.00 - Interruptor bipolar



S30.532.00 - Timbre zumbador



S30.517.00 - Regulador giratorio 1-10V



S30.512.00 - Base corriente Schuko 16A

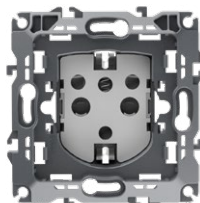

S30.514.00 - Base corriente 16A + 2USB

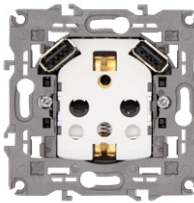

S30.513.00 - Base USB doble

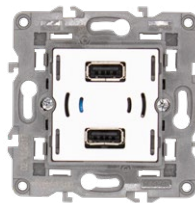

PROTECCIÓN INFANTIL

 8 UDS
 80 UDS



PROTECCIÓN INFANTIL

 6 UDS
 60 UDS

 6 UDS
 60 UDS

S30.533.10 - Base doble fibra óptica



S30.635.10 - Interruptor de tarjeta



S30.515.00 - Base teléfono RJ11
S30.516.00 - Base Red RJ45

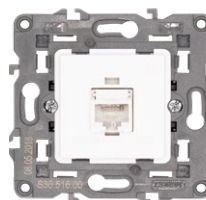

S30.700.10 - Marco embellecedor Blanco

 30 UDS
 300 UDS



S30.700.11 - Marco embellecedor Aluminio

 30 UDS
 300 UDS



S30.700.12 - Marco embellecedor Antracita

 30 UDS
 300 UDS



S30.700.13 - Marco embellecedor Grafito

 30 UDS
 300 UDS



S30.601.XX - Tecla
 S30.607.XX - Tecla Cruzamiento
 S30.609.XX - Tecla pulsador

TECLAS  30 UDS  300 UDS

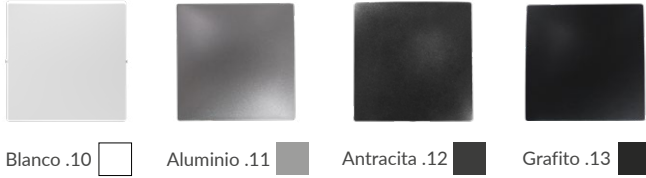

S30.603.10 - Tecla luminoso
 S30.610.10 - Tecla pulsador luminoso
 S30.627.10 - Tecla cruzamiento luminoso

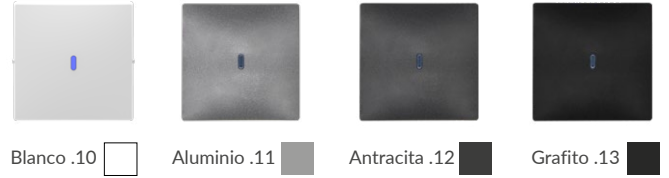

S30.604.XX - Tecla doble

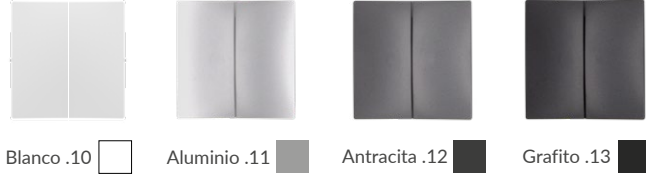

S30.606.XX - Tecla doble luminoso



S30.629.XX - Tecla pulsador con símbolo timbre

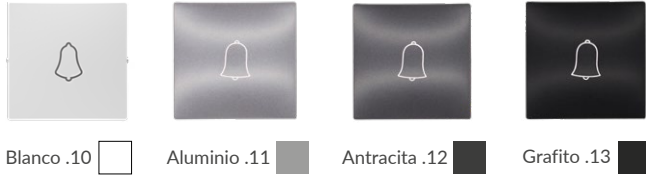

S30.608.XX - Tecla timbre

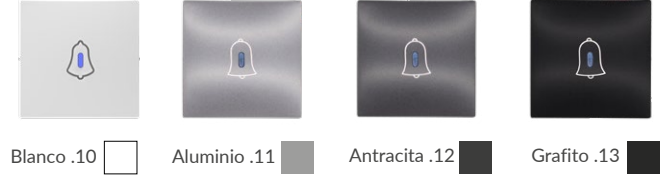

S30.628.XX - Tecla pulsador con símbolo luz



S30.630.XX - Tecla pulsador luminoso con símbolo luz



S30.620.XX - Tecla persiana

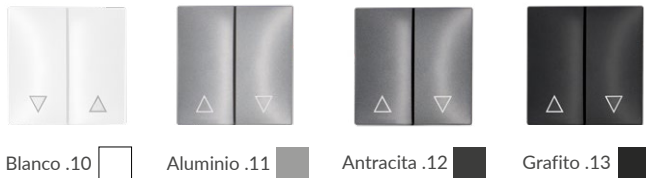

S30.634.10 - Tecla pulsador doble persiana



Marco PLÁSTICO BLANCO

S30.821.10



 15 UDS
 150 UDS

S30.822.10



 5 UDS
 50 UDS

S30.823.10



 5 UDS
 50 UDS

S30.824.10



 5 UDS
 50 UDS

Marco CRISTAL BLANCO

S30.801.10



 10 UDS
 100 UDS

S30.802.10



 5 UDS
 50 UDS

S30.803.10



 5 UDS
 50 UDS

S30.804.10



 5 UDS
 50 UDS

S30.611.XX - Tecla interruptor bipolar

TAPAS 30 UDS 300 UDS

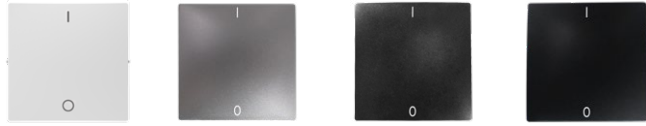

Blanco .10 Aluminio .11 Antracita .12 Grafito .13

S30.615.XX - Tapa base teléfono RJ11
S30.616.XX - Tapa base red RJ45

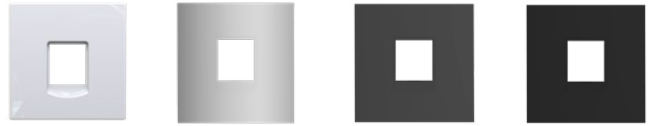

Blanco .10 Aluminio .11 Antracita .12 Grafito .13

S30.613.XX - Tapa base USB doble



Blanco .10 Aluminio .11 Antracita .12 Grafito .13

S30.617.XX - Tapa regulador giratorio 1-10V



Blanco .10 Aluminio .11 Antracita .12 Grafito .13

S30.621.XX - Tapa base TV + FM + SAT



Blanco .10 Aluminio .11 Antracita .12 Grafito .13

S30.632.XX - Tapa zumbador timbre



Blanco .10 Aluminio .11 Antracita .12 Grafito .13

S30.612.XX - Tapa base 16A 20 UDS 200 UDS



Blanco .10 Aluminio .11 Antracita .12 Grafito .13

S30.614.XX - Tapa base corriente 16A + 2USB 20 UDS 200 UDS



Blanco .10 Aluminio .11 Antracita .12 Grafito .13

S30.618.XX - Tapa ciega 10 UDS 100 UDS



Blanco .10 Aluminio .11 Antracita .12 Grafito .13

S30.631.XX - Tapa salida cables 16A 10 UDS 100 UDS

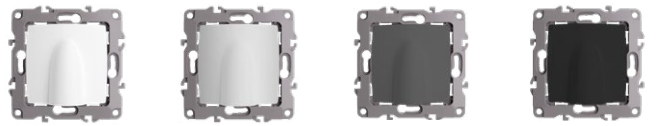

Blanco .10 Aluminio .11 Antracita .12 Grafito .13

Marco CRISTAL GRIS

S30.801.11



10 UDS
100 UDS

S30.802.11



5 UDS
50 UDS

S30.803.11



5 UDS
50 UDS

S30.804.11



5 UDS
50 UDS

Marco NEGRO BRUSHED

S30.801.16

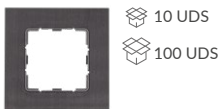

10 UDS
100 UDS

S30.802.16



5 UDS
50 UDS

S30.803.16



5 UDS
50 UDS

S30.804.16

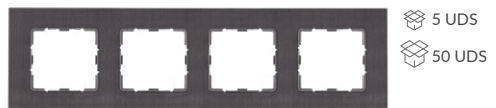

5 UDS
50 UDS

Marco ALUMINIO BRUSHED

S30.801.15

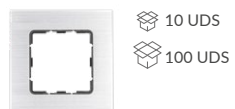

10 UDS
100 UDS

S30.802.15



5 UDS
50 UDS

S30.803.15



5 UDS
50 UDS















S30.804.15















5 UDS
50 UDS

Dynamic PLUS S30

Dynamic PLUS marco de cristal, plástico, aluminio. Teclas de policarbonato ignífugo, sistema de conexión rápida y fijación por módulos. Varios colores disponibles y posibilidad de combinar teclas, marcos, embellecedor.

	MECANISMO PVPR	TECLA-TAPA	.10	.11	.12	.13
	• Interruptor • Conmutador	S30.501.00 4,04€ / S30.601.XX S30.502.00 5,40€ / S30.601.XX	0,60€	1,48€		
	• Interruptor bipolar • Cruzamiento	S30.511.00 7,88€ / S30.611.XX S30.507.00 8,80€ / S30.607.XX	0,72€	1,64€		
	• Pulsador • Pulsador con símbolo LUZ • Pulsador con símbolo timbre	S30.509.00 4,36€ / S30.609.XX S30.528.00 4,36€ / S30.628.XX S30.529.00 4,36€ / S30.629.XX	0,60€ 0,64€ 0,64€	1,48€ 1,64€ 1,64€		
	• Interruptor luminoso LED • Conmutador luminoso LED • Cruzamiento luminoso LED • Pulsador luminoso LED • Pulsador luminoso símbolo luz • Pulsador luminoso timbre LED	S30.503.00 7,24€ / S30.603.XX S30.522.00 8,60€ / S30.603.XX S30.527.00 12,08€ / S30.627.XX S30.510.00 7,60€ / S30.610.XX S30.530.00 7,60€ / S30.630.XX S30.508.00 7,60€ / S30.608.XX	0,68€ 0,68€ 0,72€ 0,68€ 0,72€ 0,68€	1,60€ 1,60€ 1,72€ 1,60€ 1,72€ 1,60€		
	• Interruptor doble • Conmutador doble	S30.504.00 8,64€ / S30.604.XX S30.505.00 8,48€ / S30.604.XX	0,72€	2,08€		
	• Interruptor doble lumi. LED • Conmutador doble lumi. LED	S30.506.00 12,20€ / S30.606.XX S30.523.00 14,64€ / S30.606.XX	0,80€	2,12€		
	• Interruptor de persianas • Pulsador doble p/ persianas	S30.520.00 7,08€ / S30.620.XX S30.534.00 7,48€ / S30.634.10	0,72€ 0,80€	1,64€ 8,72		S30.620.XX 1,64€
	• Regulador giratorio 1-10V Máx. 300W LED	S30.517.00 48,68€ / S30.617.XX	1,08€	2,64€		
	• Base corriente Schuko 16A Con protección infantil Conexión por tornillos	S30.512.00 5,80€ / S30.612.XX	1,20€	2,00€		
	• Base corriente Schuko 16A Con protección infantil Conexión por tornillos 2 puertos USB	S30.514.00 46,16€ / S30.614.XX	1,08€	2,24€		
	• Base doble USB 2.1A	S30.513.00 46,52€ / S30.613.XX	0,68€	1,56€		
	• Base teléfono RJ11 (CAT3) • Base red RJ45 (CAT6)	S30.515.00 7,48€ / S30.615.XX S30.516.00 9,36€ / S30.616.XX	0,68€ 0,68€	1,60€ 1,60€		
	• Tapa Universal TV - FM - SAT	Tapa - S30.621.XX	2,12€	3,00€		
	• Timbre Zumbador	S30.532.00 21,84€ / S30.632.XX	0,80€	1,88€		
	• Base doble fibra óptica/Blanco - Mecanismo con tapa. - Añadir marco y embellecedor	S30.533.10 10,92€				
	• Interruptor de Tarjeta/Blanco - Mecanismo con tapa. - Añadir marco y embellecedor	S30.635.10 63,16€				
	• Tapa salida cables • Tapa ciega	Tapa - S30.631.XX Tapa - S30.618.XX	2,88€ 1,96€	4,56€ 2,84€		

		Blanco.10	Gris.11	Aluminio.11	Antracita.12	Grafito.13
	• Marco embellecedor	S30.700.XX 1,08€		1,96€	1,96€	1,96€
	• Marco cristal 1 elemento	S30.801.XX 14,32€	14,32€			
	• 2 elementos	S30.802.XX 32,20€	32,20€			
	• 3 elementos	S30.803.XX 47,20€	47,20€			
	• 4 elementos	S30.804.XX 72,00€	72,00€			
	• Marco plástico 1 elemento	S30.821.10 1,68€				
	• 2 elementos	S30.822.10 2,92€				
	• 3 elementos	S30.823.10 3,68€				
	• 4 elementos	S30.824.10 4,80€				
			Aluminio brushed.15	Negro brushed.16		
	• Marco aluminio brushed 1 elemento	S30.801.XX 18,52€		18,52€		
	• 2 elementos	S30.802.XX 36,32€		36,32€		
	• 3 elementos	S30.803.XX 51,08€		51,08€		
	• 4 elementos	S30.804.XX 66,24€		66,24€		

Precio PVPR

Combinación: Mecanismo + tecla + Cerquillo + Marco

Precio en color:

- **BLANCO.10**
- **ALUMINIO.11** (+ MARCO VIDRIO GRIS.11)
- **ANTRACITA.12** (+ MARCO NEGRO BRUSHED.16)

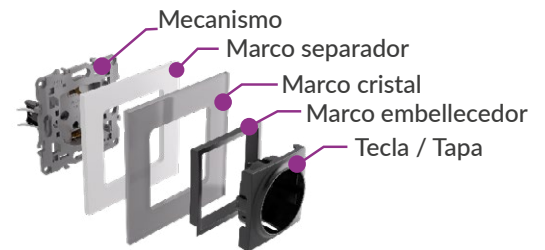

PRODUCTO COMPLETO	.10 BLANCO	.11 ALUMINIO	.12 ANTRACITA
Interruptor Unipolar	7,40€	21,80€	26€
Conmutador	8,76€	23,16€	27,36€
Interruptor bipolar	11,36€	25,80€	30€
Cruzamiento	12,32€	26,64€	30,84€
Pulsador	7,72€	22,12€	56,32€
Pulsador con símbolo luz	7,76€	22,28€	26,48€
Pulsador con símbolo timbre	6,08€	22,28€	26,48€
Interruptor luminoso LED	10,68€	25,12€	29,32€
Conmutador luminoso LED	12,04€	26,48€	30,68€
Cruzamiento luminoso LED	15,56€	30,08€	34,28€
Pulsador luminoso LED	11,04€	25,48€	29,68€
Pulsador luminoso símbolo luz	11,08€	25,60€	29,80€
Pulsador luminoso timbre LED	11,04€	25,48€	29,68€
Interruptor doble	12,12€	27€	31,20€
Conmutador doble	11,96€	26,84€	31,04€
Interruptor doble luminoso LED	15,76€	30,60€	34,80€
Conmutador doble luminoso LED	18,20€	33,04€	37,24€
Interruptor de persianas	10,56€	25€	29,20€
Pulsador doble para persianas	11,04€	25,40€	29,60€
Regulador giratorio 1-10V	52,52€	67,60€	71,80€
Base corriente Schuko 16A	9,76€	24,08€	28,28€
Base corriente Schuko 16A + 2 puertos usb	50€	64,68€	68,88€
Base doble USB 2.1A	49,96€	64,36€	68,56€
Base teléfono RJ11	10,92€	25,36€	29,56€
Base red RJ45	12,80€	27,24	31,44€
Tapa universal TV+FM+SAT	4,88€	19,28€	23,48€
Timbre zumbador	25,40€	40€	44,20€
Base doble fibra óptica/blanco	13,68€		
Interruptor tarjeta/blanco	65,92€		
Tapa salida cables	5,64€	20,84€	25,04€
Tapa ciega	4,72€	19,12€	23,32€

Dynamic ART S40

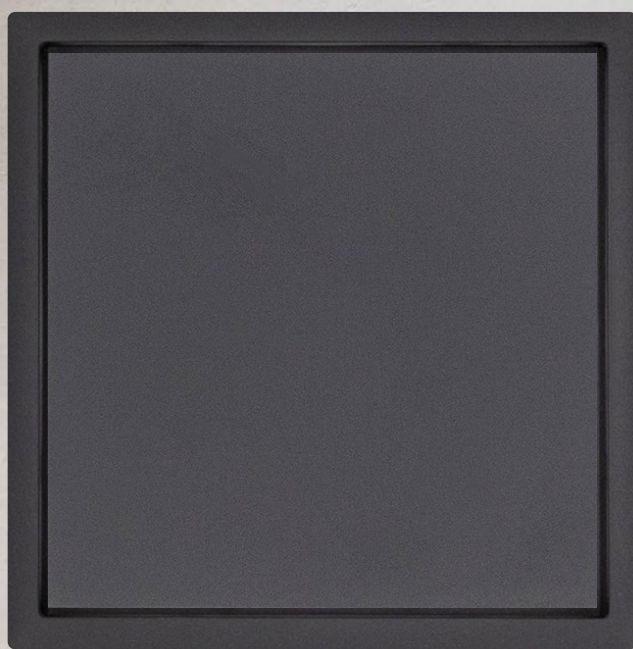



Cambio suave y silencioso.

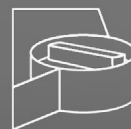

La fijación de múltiples puntos del marco de acero con piezas de montaje hace que todo el cuerpo sea más sólido y fiable.

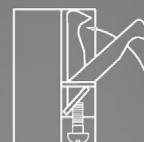

Las garras están situadas en agujeros especialmente designados. Esto hace que la instalación sea más conveniente.

Ag



Las partes de los contactos móviles están cubiertas de plata con un grosor no inferior a 0,4 mm



El plano de contacto de la conexión del cableado se realiza como "puente de arco" para una fijación más fiable del cable.



La cubierta de los contactos es de material ignífugo.

Cu	93,5%
Sn	6%
P	0,5%

Piezas conductoras: el bronce fosforado de alta calidad proporciona un alto grado de conductividad y durabilidad.



El grosor de las piezas conductoras de más de 0,8 mm evita su calentamiento y tensión.

Dynamic ART S40

DESCARGAR FICHAS TÉCNICAS

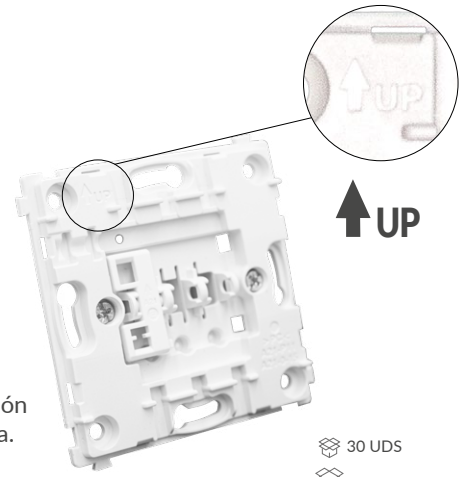

TODOS LOS MECANISMOS NECESITAN MARCO Y TAPA/TECLA

MECANISMOS

10 UDS
100 UDS

Comprobar flecha de posición en mecanismo y tapa/tecla.

30 UDS
300 UDS



S40.501.00
INTERRUPTOR
MECANISMO

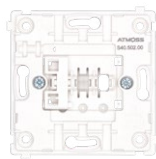

S40.502.00 CONMUTADOR
MECANISMO



S40.504.00
INTERRUPTOR DOBLE
MECANISMO



S40.520.00
PULSADOR PERSIANA
MECANISMO



S40.505.00
CONMUTADOR DOBLE
MECANISMO



S40.512.00
BASE CORRIENTE 16A
MECANISMO

8 UDS
80 UDS



S40.507.00
CRUZAMIENTO
MECANISMO



S40.513.00
BASE CORRIENTE 16A
CON USB TIPO A Y C
MECANISMO

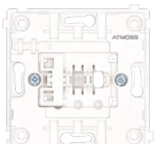

S40.508.00
PULSADOR TIMBRE
MECANISMO



S40.516.10
BASE RED DOBLE
RJ45 CAT.6 BLANCO
MECANISMO



S40.509.00
PULSADOR PARA ESCALERA
CON LED
MECANISMO



S40.516.11
BASE RED DOBLE
RJ45 CAT.6 ALUMINIO
MECANISMO



S40.515.10
BASE TELF + RED
RJ11 + RJ45 BLANCO
MECANISMO



S40.516.17
BASE RED DOBLE
RJ45 CAT.6 NEGRO
MECANISMO

NEW!

S40.517.17
BASE RED DOBLE
RJ45 CAT.6 NEGRO
SIN CONECTOR
MECANISMO



S40.515.11
BASE TELF + RED
RJ11 + RJ45 ALUMINIO
MECANISMO



S40.518.17
BASE RED UNO
RJ45 CAT.6 NEGRO
SIN CONECTOR
MECANISMO



S40.515.17
BASE TELF + RED
RJ11 + RJ45 NEGRO
MECANISMO



S40.533.00
BASE DOBLE FIBRA ÓPTICA
MECANISMO

30 UDS 300 UDS



S40.401.10
TECLA
BLANCO **BRILLO**

30 UDS 300 UDS



S40.402.10
TECLA DOBLE
BLANCO **BRILLO**

30 UDS 300 UDS

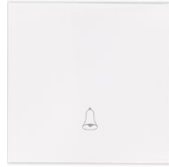

S40.403.10
TECLA SÍMBOLO
TIMBRE
BLANCO **BRILLO**

30 UDS 300 UDS

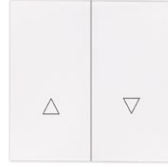

S40.404.10
TECLA DOBLE
CORTINA
BLANCO **BRILLO**

8 UDS 80 UDS

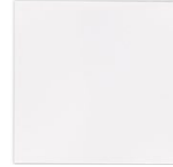

S40.618.10
TAPA CIEGA
BLANCO **BRILLO**

NEW!

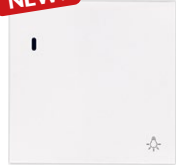

S40.409.10
TECLA PULSADOR
ESCALERA CON LED
BLANCO **BRILLO**

S40.401.18
TECLA
BLANCO **MATE**

S40.402.18
TECLA DOBLE
BLANCO **MATE**

S40.403.18
TECLA SÍMBOLO
TIMBRE
BLANCO **MATE**

S40.404.18
TECLA DOBLE
CORTINA
BLANCO **MATE**

S40.618.18
TAPA CIEGA
BLANCO **MATE**

S40.409.18
TECLA PULSADOR
ESCALERA CON LED
BLANCO **MATE**

30 UDS 300 UDS



S40.405.10
TAPA BASE
CORRIENTE 16A
BLANCO **BRILLO**

NEW!



S40.408.10
TAPA BASE
CORRIENTE 16A
CON USB A y C
BLANCO **BRILLO**

30 UDS 300 UDS



S40.406.10 TAPA PARA
· BASE TELEF + RED. **RJ11 + RJ45**
· BASE RED DOBLE **RJ45**
· BASE DOBLE **FIBRA ÓPTICA**
BLANCO **BRILLO**

8 UDS 80 UDS



S40.407.10
TAPA BASE
TV+FM+SAT
BLANCO **BRILLO**

8 UDS 80 UDS



S40.419.10
TAPA SALIDA CABLE
BLANCO **BRILLO**

S40.405.18
TAPA BASE
CORRIENTE 16A
BLANCO **MATE**

S40.408.18
TAPA BASE
CORRIENTE 16A
CON USB A y C
BLANCO **MATE**

S40.406.18 TAPA PARA
· BASE TELEF + RED. **RJ11 + RJ45**
· BASE RED DOBLE **RJ45**
· BASE DOBLE **FIBRA ÓPTICA**
BLANCO **MATE**

S40.407.18
TAPA BASE
TV+FM+SAT
BLANCO **MATE**

S40.419.18
TAPA SALIDA CABLE
BLANCO **MATE**



30 UDS
300 UDS

S40.201.10
MARCO 1 ELEMENTO
BLANCO **BRILLO**

S40.201.18
MARCO 1 ELEMENTO
BLANCO **MATE**

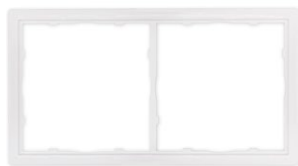

15 UDS
150 UDS

S40.202.10
MARCO 2 ELEMENTO
BLANCO **BRILLO**

S40.202.18
MARCO 2 ELEMENTO
BLANCO **MATE**



8 UDS
80 UDS

S40.203.10
MARCO 3 ELEMENTO
BLANCO **BRILLO**

S40.203.18
MARCO 3 ELEMENTO
BLANCO **MATE**



8 UDS
80 UDS

S40.204.10
MARCO 4 ELEMENTO
BLANCO **BRILLO**

S40.204.18
MARCO 4 ELEMENTO
BLANCO **MATE**

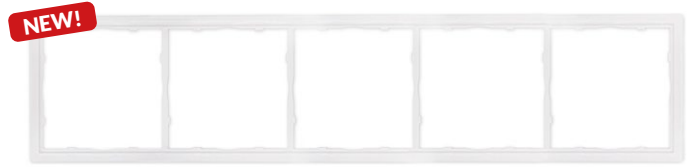

NEW!

S40.205.10
MARCO 5 ELEMENTO
BLANCO **BRILLO**

SERIE NEGRO MATE

30 UDS 300 UDS



S40.401.17

TECLA

NEGRO MATE

30 UDS 300 UDS

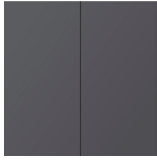

S40.402.17

TECLA DOBLE

NEGRO MATE

30 UDS 300 UDS



S40.403.17

TECLA SIMBOLO
TIMBRE

NEGRO MATE

30 UDS 300 UDS



S40.404.17

TECLA DOBLE
CORTINA

NEGRO MATE

8 UDS 80 UDS



S40.618.17

TECLA CIEGA

NEGRO MATE

NEW!

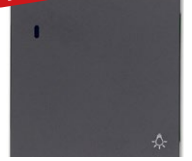

S40.409.17

TECLA PULSADOR
ESCALERA CON LED

NEGRO MATE

30 UDS 300 UDS



S40.405.17

TAPA BASE
CORRIENTE 16A

NEGRO MATE

NEW!



S40.408.17

TAPA BASE
CORRIENTE 16A
CON USB A y C

NEGRO MATE

30 UDS 300 UDS

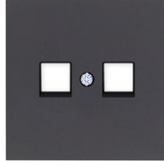

S40.406.17

· BASE TELEF + RED.
· BASE RED DOBLE
· BASE DOBLE

NEGRO MATE

TAPA PARA
RJ11 + RJ45
RJ45
FIBRA ÓPTICA

8 UDS 80 UDS



S40.407.17

TAPA BASE
TV+FM+SAT

NEGRO MATE

8 UDS 80 UDS



S40.419.17

TAPA SALIDA
CABLE

NEGRO MATE

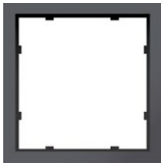

30 UDS
300 UDS

S40.201.17

MARCO 1 ELEMENTO

NEGRO MATE

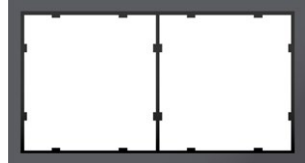

15 UDS
150 UDS

S40.202.17

MARCO 2 ELEMENTO

NEGRO MATE

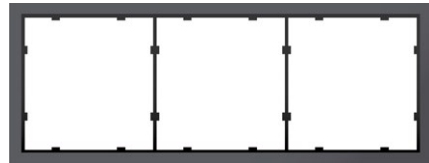

8 UDS
80 UDS

S40.203.17

MARCO 3 ELEMENTO

NEGRO MATE



8 UDS
80 UDS

S40.204.17

MARCO 4 ELEMENTO

NEGRO MATE

NEW!

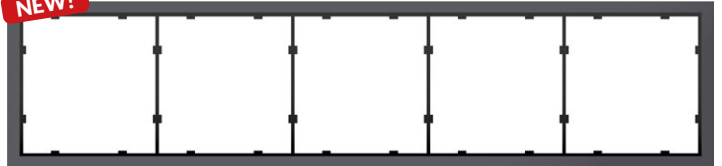

S40.205.17

MARCO 5 ELEMENTO

NEGRO MATE

SERIE ALUMINIO MATE

30 UDS 300 UDS



S40.401.11
TECLA
ALUMINIO MATE

30 UDS 300 UDS

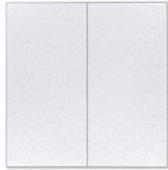

S40.402.11
TECLA DOBLE
ALUMINIO MATE

30 UDS 300 UDS



S40.403.11
TECLA SIMBOLO TIMBRE
ALUMINIO MATE

30 UDS 300 UDS



S40.404.11
TECLA DOBLE CORTINA
ALUMINIO MATE

8 UDS 80 UDS



S40.618.11
TAPA CIEGA
ALUMINIO MATE

NEW!



S40.409.11
TECLA PULSADOR ESCALERA CON LED
ALUMINIO MATE

30 UDS 300 UDS



S40.405.11
TAPA BASE CORRIENTE 16A
ALUMINIO MATE

NEW!



S40.408.11
TAPA BASE CORRIENTE 16A CON USB A y C
ALUMINIO MATE

30 UDS 300 UDS

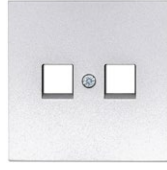

S40.406.11
TAPA PARA
· BASE TELEF + RED. **RJ11 + RJ45**
· BASE RED DOBLE **RJ45**
· BASE DOBLE **FIBRA ÓPTICA**
ALUMINIO MATE

8 UDS 80 UDS



S40.407.11
TAPA BASE TV+FM+SAT
ALUMINIO MATE

8 UDS 80 UDS



S40.419.11
TAPA SALIDA CABLE
ALUMINIO MATE



30 UDS
300 UDS

S40.201.11
MARCO 1 ELEMENTO
ALUMINIO MATE

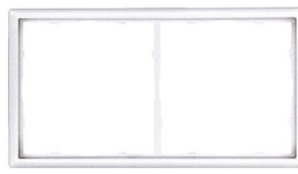

15 UDS
150 UDS

S40.202.11
MARCO 2 ELEMENTO
ALUMINIO MATE



8 UDS
80 UDS

S40.203.11
MARCO 3 ELEMENTO
ALUMINIO MATE

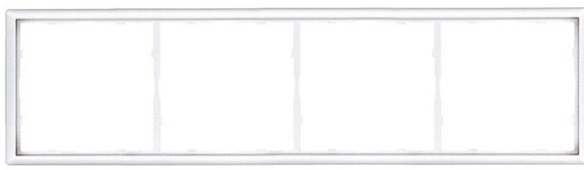

8 UDS
80 UDS

S40.204.11
MARCO 4 ELEMENTO
ALUMINIO MATE

Dynamic ART S40

Estilo renovado con su forma cuadrada y un marco fino. Se integran discretamente en cualquier ambiente. Una selección de materiales de alta calidad que ofrece todas las opciones para hacer que las ideas personales de decoración se hagan realidad.

MECANISMO PVPR / TECLA-TAPA .10 .18 Mate .11 .17



· Interruptor	S40.501.00	6,40€	/	S40.401.XX	1,48€	2,20€	2,56€
· Conmutador	S40.502.00	7,08€	/	S40.401.XX	1,48€	2,20€	2,56€
· Cruzamiento	S40.507.00	10,60€	/	S40.401.XX	1,48€	2,20€	2,56€



· Interruptor doble	S40.504.00	8,04€	/	S40.402.XX	2,20€	2,84€	3,08€
· Conmutador doble	S40.505.00	9,68€	/	S40.402.XX	2,20€	2,84€	3,08€



· Pulsador timbre	S40.508.00	7,08€	/	S40.403.XX	1,88€	2,36€	2,88€
-------------------	------------	-------	---	------------	-------	-------	-------



· Pulsador persiana	S40.520.00	8,96€	/	S40.404.XX	2,36€	3,00€	3,60€
· Tecla pulsador escalera con led	S40.509.00	10,16€	/	S40.409.XX	1,84€	2,56€	2,84€



· Base corriente 16A	S40.512.00	6,04€	/	S40.405.XX	3,00€	3,72€	4,40€
----------------------	------------	-------	---	------------	-------	-------	-------



· Base corriente 16A USB Tipo A,C	S40.513.00	6,04€	/	S40.408.XX	2,92€	4,08€	4,40€
-----------------------------------	------------	-------	---	------------	-------	-------	-------

La base de teléfono y base de red doble tiene un color a elegir .10 / .11 / .17

MECANISMO



TAPA



· Base teléfono + Red (RJ11 + RJ45)	S40.515.XX	24,32€	26,08€	26,08€	/	S40.406.XX	1,72€	2,72€	3,28€
· Base Red doble RJ45 (CAT.6)	S40.516.XX	28,64€	30,68€	30,68€	/	S40.406.XX	1,72€	2,72€	3,28€
· Base Red doble RJ45 SIN CONECTOR	S40.517.17			7,12€	/	S40.406.XX	1,72€	2,72€	3,28€
· Base Red uno RJ45 SIN CONECTOR	S40.518.17			6,64€					



· Base doble fibra óptica	S40.533.00	17,12€	S40.406.XX	1,72€	3,28€
---------------------------	------------	--------	------------	-------	-------



· Tapa universal TV + FM + SAT	S40.407.XX	1,56€	2,64€	3,08€
--------------------------------	------------	-------	-------	-------



· Tapa Salida cable	S40.419.XX	5,04€	5,12€	6,72€
· Tapa Ciega	S40.618.XX	5,12€	5,92€	6,88€

<input type="checkbox"/>	Blanco.....	10
<input type="checkbox"/>	Blanco mate.....	18
<input type="checkbox"/>	Aluminio.....	11
<input type="checkbox"/>	Antracita.....	12
<input type="checkbox"/>	Grafito.....	13
<input type="checkbox"/>	Negro.....	17

Marcos disponibles en:

Blanco.10 Blanco mate.18 Aluminio.11 Negro.17

· Marco plástico 1 elemento	S40.201.XX	1,56€	2,08€	2,44€	2,44€
· Marco plástico 2 elementos	S40.202.XX	2,36€	4,08€	4,72€	4,72€
· Marco plástico 3 elementos	S40.203.XX	5,88€	7,80€	11,84€	11,84€
· Marco plástico 4 elementos	S40.204.XX	6,96€	9,04€	14,84€	14,84€
· Marco plástico 5 elementos	S40.205.XX	9,44€			19,92€

Precio PVPR

Combinación: Mecanismo + Tecla/Tapa + Marco 1 elemento

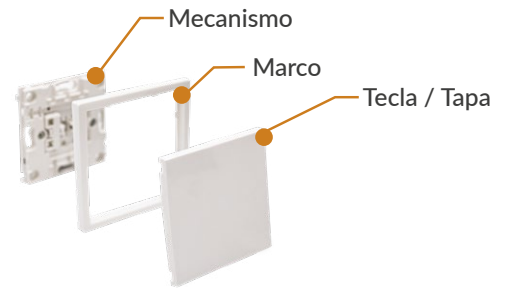

Precio en color:

- BLANCO.10
- BLANCO MATE .18
- ALUMINIO.11
- NEGRO.17

PRODUCTO COMPLETO	.10 BLANCO	.18 BLANCO MATE	.11 ALUMINIO .17 NEGRO
Interruptor Unipolar	9,44€	10,68€	11,40€
Conmutador	10,12€	11,36€	12,08€
Cruzamiento	13,64€	14,88€	15,60€
Interruptor doble	11,80€	12,96€	13,56€
Conmutador doble	13,44€	14,60€	15,20€
Pulsador timbre	10,52€	11,52€	12,40€
Pulsador persiana	12,88€	14,04€	15€
Base corriente 16A	10,60€	11,84€	12,88€
Base teléfono + red (RJ45+ RJ11)	27,60€	29,12€	31,80€
Base red doble RJ45	31,92€	33,44€	36,40€
Base doble fibra óptica	20,40€	--	22,84€
Tapa universal TV + FM + SAT	3,12€	4,20€	5,52€
Tapa salida cable	6,60€	7,20€	9,16€
Tapa ciega	6,68€	8,00€	9,32€

Mecanismos S55

EXTERIOR IP55



 DESCARGAR
FICHAS TÉCNICAS

Los **mecanismos S55** son la nueva propuesta de Atmos de interruptores y enchufes para exterior y zonas al aire libre. Esta nueva gama cuenta con interruptores y enchufes para **superficies y empotrados** con un diseño ergonómico muy decorativo.

Lo mejor de estos mecanismos es que son capaces de resistir en el exterior a diversas condiciones medioambientales.

Ventajas

Diseño innovador: el estilo de los mecanismos es robusto y con perfil curvado, todo ello combinado con un estilo moderno y contemporáneo. También tienen un avanzado diseño ergonómico que facilita su instalación.

Empotrados y de superficie: tanto si quieres sustituir tus actuales mecanismos, como si tienes que realizar una nueva instalación, podrás elegir entre sus dos opciones.

Mecanismos seguros y robustos: gracias a su clasificación **IP55** son impermeables, mientras que su clasificación **IK06** los hace resistentes contra la suciedad el polvo y productos solventes, como cementos, pegamentos o removedores de pintura y barniz. Sus componentes están reforzados con fuertes herrajes para mecanismos, cajas y marcos rígidos, así como una junta de membrana impermeable. Esa clasificación IK06 significa también que son resistentes a los rayos UV, lo que significa que la versión en blanco polar no sufre decoloración con el tiempo.

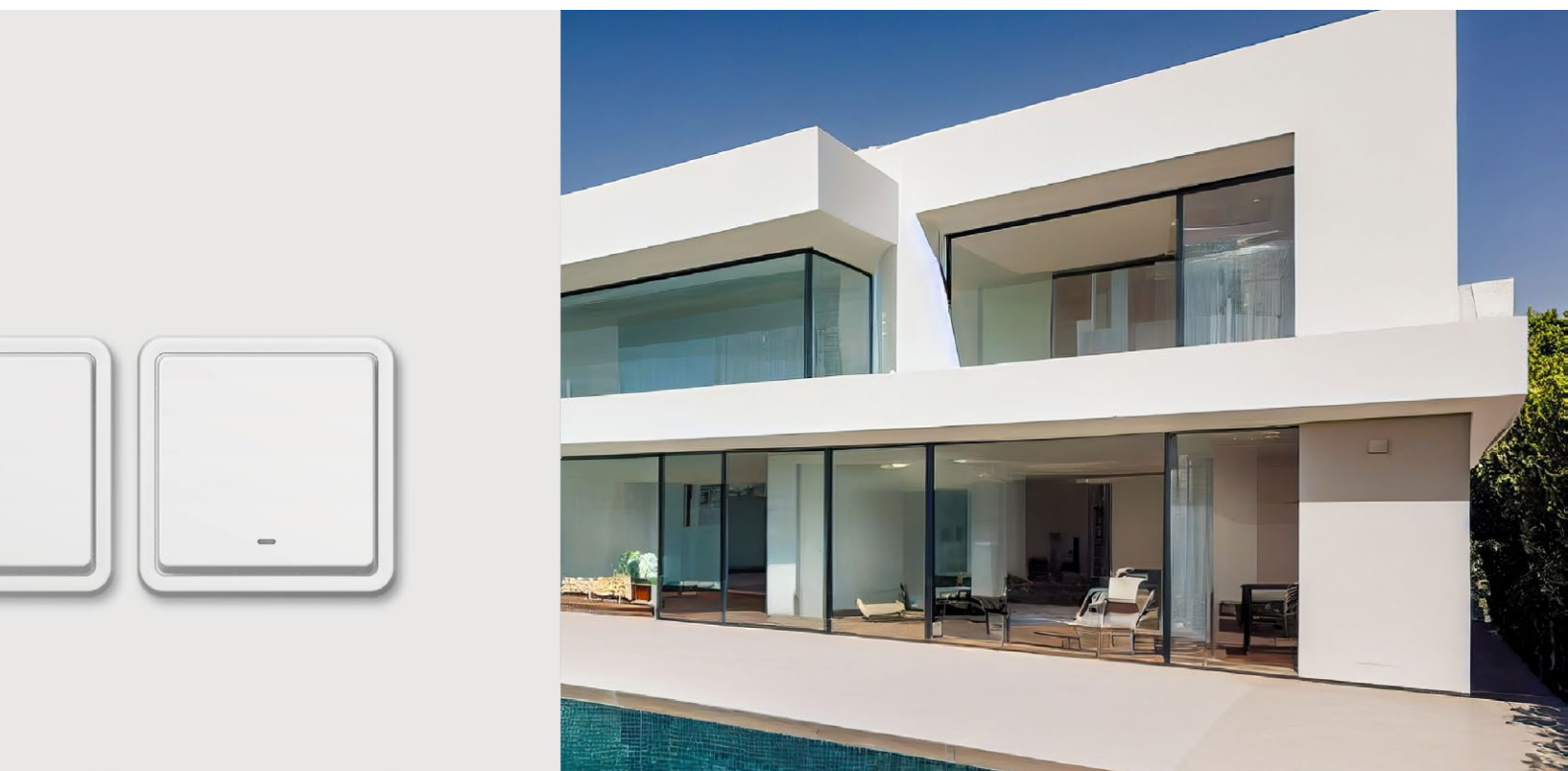

Aplicaciones y combinaciones diferentes

**MÚLTIPLES
COMBINACIONES**

- Posibilidad de empotrado o superficie.
- Protección IP55

MECANISMO EMPOTRADO

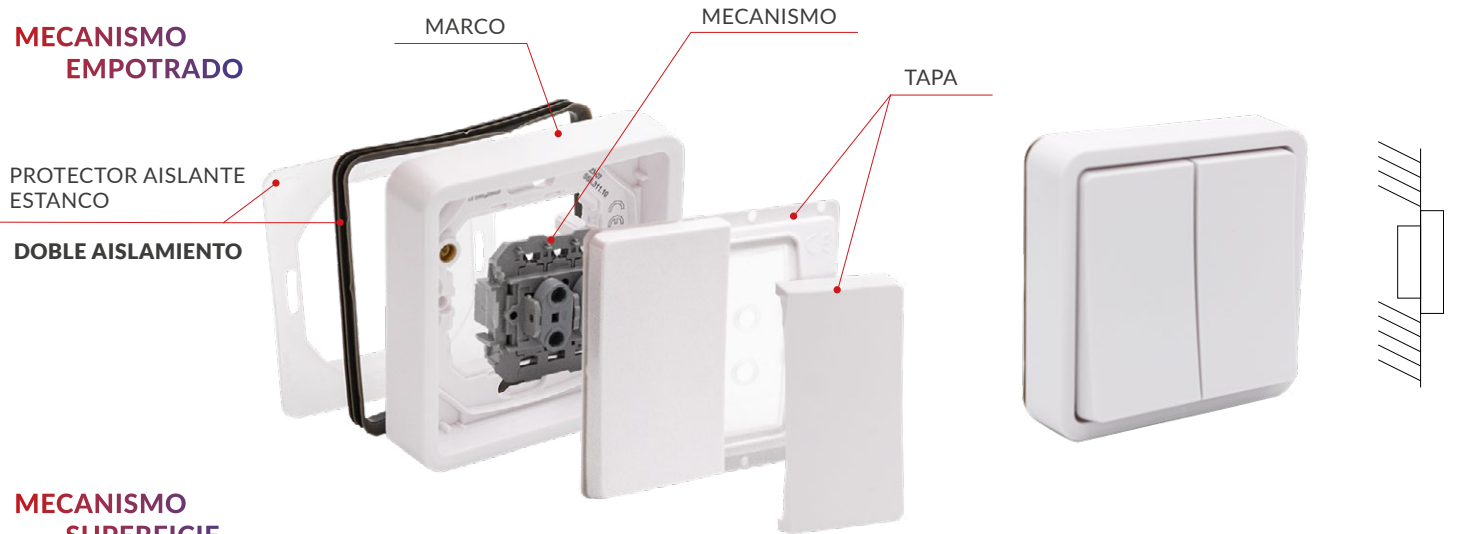

MECANISMO SUPERFICIE

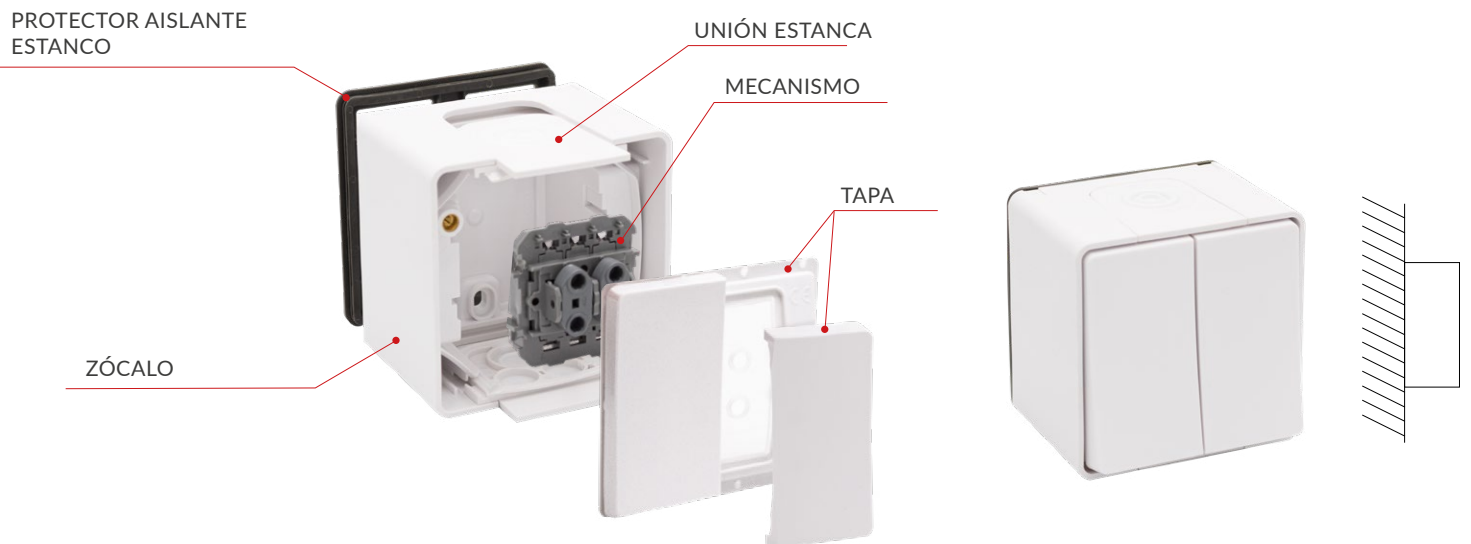

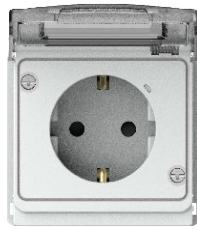
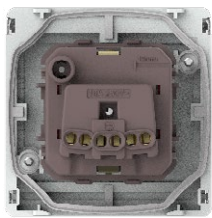

S55.112.10

BASE CORRIENTE 16A CON TAPA
BLANCO S55

8 UDS

PVPR - 8,24€

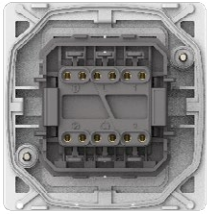

S55.105.10

CONMUTADOR DOBLE BLANCO S20

10 UDS

PVPR - 11,44€



S55.102.10

CONMUTADOR BLANCO S55

10 UDS

PVPR - 8,16€

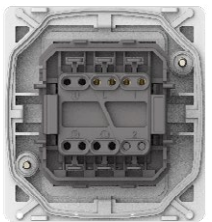

S55.109.10

PULSADOR BLANCO S55

10 UDS

PVPR - 6,88€

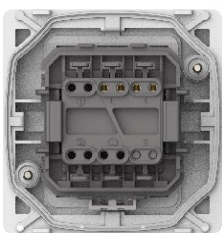

S55.110.10

PULSADOR LUMINOSO BLANCO S55

10 UDS

PVPR - 8,72€

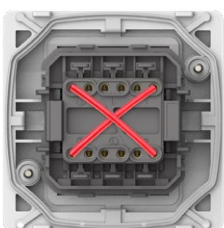

NEW!

S55.124.10

CRUZAMIENTO BLANCO BLANCO S55

8 UDS

PVPR - 16,96€

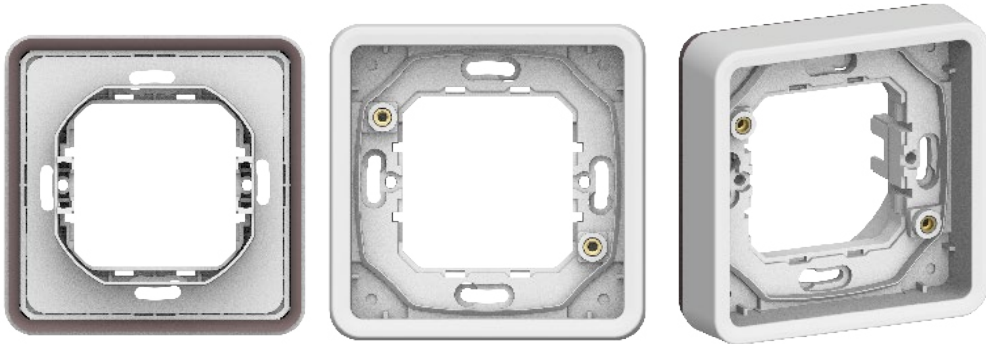

S55.311.10

MARCO 1 ELEMENTO BLANCO S55
EMPOTRAR

12 UDS

PVPR - 5,44€



S55.312.10

MARCO 2 ELEMENTOS BLANCO S55
EMPOTRAR

6 UDS

PVPR - 10,32€

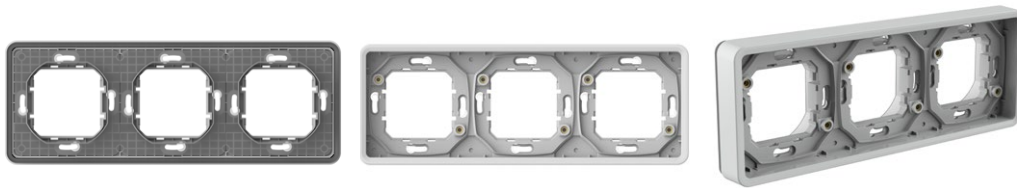

NEW!

S55.313.10

MARCO 3 ELEMENTOS BLANCO S55
EMPOTRAR

5 UDS

PVPR - 16,80€

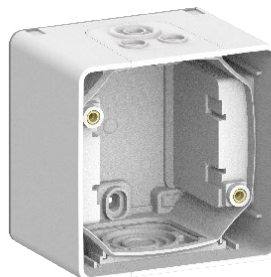

S55.910.10

CAJA SUPERFICIE 1 ELEMENTO PARA
MECANISMOS S55

8 UDS

PVPR - 5,60€

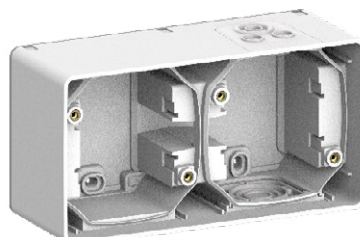
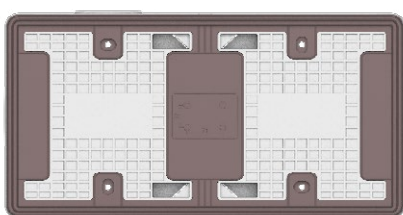

S55.911.10

CAJA SUPERFICIE 2 ELEMENTOS PARA
MECANISMOS S55

4 UDS

PVPR - 8,40€

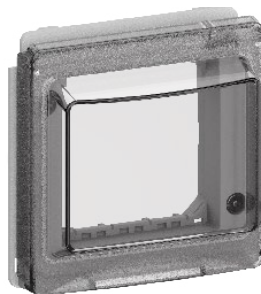
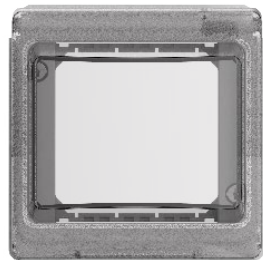
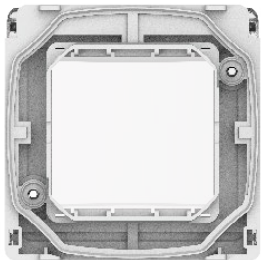

**SOLO VÁLIDO PARA LOS
MÓDULOS ESTRECHOS**

S55.310.10

TAPA PARA MARCO EST/EMP VARIOS
MECANISMOS S55

14 UDS

PVPR - 3,44€

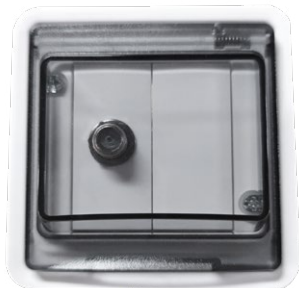

**Combina con los módulos
estrechos a tu gusto**



NEW!

S55.512.10

CONMUTADOR ESTRECHO BLANCO
MECANISMO S55

16 UDS

PVPR - 4,76€



S55.601.10

TAPA CIEGA MÓDULO ESTRECHO
MECANISMO S55

30 UDS

PVPR - 1,12€



S55.516.10

BASE RED RJ45 MÓDULO ESTRECHO
MECANISMO S55

16 UDS

PVPR - 13,92€



S55.535.10

BASE TV MÓDULO ESTRECHO
MECANISMO S55

16 UDS

PVPR - 9,68€

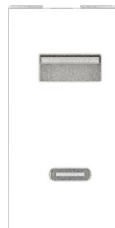

S55.513.10

BASE USB+TIPO C MÓDULO ESTRECHO
MECANISMO S55

12 UDS

PVPR - 45,92€

FICHA TÉCNICA

Precios PVPR

Referencia	Descripción	PVPR	UDS
S55.112.10	BASE CORRIENTE 16A CON TAPA BLANCO S55	PVPR - 8,24€	 8 UDS
S55.105.10	CONMUTADOR DOBLE BLANCO S20	PVPR - 11,44€	 10 UDS
S55.102.10	CONMUTADOR BLANCO S55	PVPR - 8,16€	 10 UDS
S55.109.10	PULSADOR EMPOTRAR BLANCO S55	PVPR - 6,88€	 10 UDS
S55.110.10	PULSADOR LUMINOSO EMPOTRAR BLANCO S55	PVPR - 8,72€	 10 UDS
S55.311.10	MARCO 1 ELEMENTO BLANCO S55	PVPR - 5,44€	 12 UDS
S55.312.10	MARCO 2 ELEMENTOS BLANCO S55	PVPR - 10,32€	 6 UDS
S55.312.10	MARCO 2 ELEMENTOS BLANCO S55	PVPR - 10,32€	 6 UDS
S55.910.10	CAJA SUPERFICIE 1 ELEMENTO PARA MECANISMOS S55	PVPR - 5,60€	 8 UDS
S55.911.10	CAJA SUPERFICIE 2 ELEMENTOS PARA MECANISMOS S55	PVPR - 8,40€	 4 UDS
S55.310.10	TAPA PARA MARCO EST/EMP VARIOS MECANISMOS S55	PVPR - 3,44€	 14 UDS
S55.516.10	BASE RED RJ45 MODULO ESTRECHO MECANISMO S55	PVPR - 13,92€	 16 UDS
S55.535.10	BASE TV MODULO ESTRECHO MECANISMO S55	PVPR - 9,68€	 16 UDS
S55.513.10	BASE USB+TIPO C MODULO ESTRECHO MECANISMO S55	PVPR - 45,92€	 12 UDS
S55.601.10	TAPA CIEGA MODULO ESTRECHO MECANISMOS S55	PVPR - 1,12€	 30 UDS



IP65



Estanco 

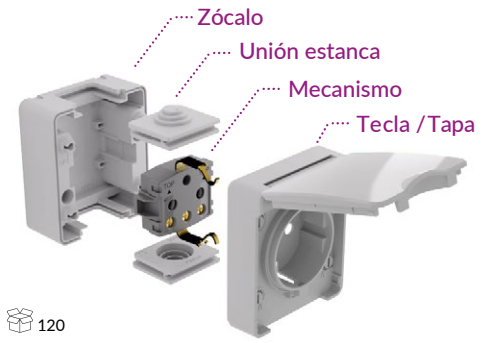

CONEXIÓN CON TORNILLOS

IP65

PARA EXTERIOR

12

120



Descripción

Código

PVPR

Interruptor (10A-250V~)

S60.401.14

9,36€

Conmutador (10A-250V~)

S60.402.14

11,84€

Pulsador piloto LED (10A-250V~)

S60.403.14

13,92€

Conmutador doble (10A-250V~)

S60.404.14

14,24€

Base Schuko enchufe (16A-250V~)

S60.405.14

9,96€

Block doble base Schuko (16A-250V~)

S60.406.14

20,40€

Block base Schuko + Int - Conmut (16A-250V~)

S60.407.14

24,76€

Unión para mecanismo SUPERFICIE S60

S60.407.14

13,88€



ACLED-475



ACLED-476

Interruptor Temporizador táctil



Hecho de material de PVC de **ALTA CALIDAD, RESISTENTE Y DURADERO, FÁCIL DE LIMPIAR**. El sensor táctil es muy sensible y **FÁCIL DE USAR**, cuando lo tocas, el indicador LED se enciende. Relé de alta potencia de 16A, este interruptor es compatible con todo tipo de lámparas incandescentes y fluorescentes. Con **16 NIVELES DE AJUSTE DE TIEMPO**, oscila entre 2 minutos y 120 minutos, más ahorro de energía. Adecuado para **USO EN EXTERIORES E INTERIORES**, ampliamente utilizado en muchos lugares, como almacenes, escaleras, etc.

• Tiempo mínimo:	• Tiempo máximo:		
2 minutos	2 horas	1 UDS	
INTERRUPTOR TÁCTIL TEMPORIZADOR DE PARED	BLANCO	REF ACLED-475	PVPR 59,70€
INTERRUPTOR TÁCTIL TEMPORIZADOR DE PARED	NEGRO	REF ACLED-476	PVPR 59,70€

[DESCARGAR FICHA TÉCNICA](#)

Descripción:

- AHORRO DE ENERGÍA:** Con 16 configuraciones de temporizador de 2 minutos a 120 minutos, puede encender y apagar las luces de su casa automáticamente, ahorrando tiempo y energía
- ILUMINACIÓN VERSÁTIL:** Relé de alto rendimiento de 16A, este interruptor de luz es compatible con todo tipo de lámparas incandescentes y fluorescentes para uso exterior o interior, versátil en muchos lugares como almacenes, escaleras, etc.
- FÁCIL INSTALACIÓN :** La instalación fácil ahorra tiempo. Apague la alimentación en el disyuntor para evitar descargas eléctricas. Simplemente retire su interruptor existente, instale el interruptor de luz y encienda el disyuntor
- SENSOR TÁCTIL LED:** El sensor táctil es muy sensible y fácil de usar. Cuando lo tocas, la luz LED se enciende para ayudarte a localizar fácilmente los interruptores de luz en la oscuridad



Uso ideal para:

Almacenes



Garajes

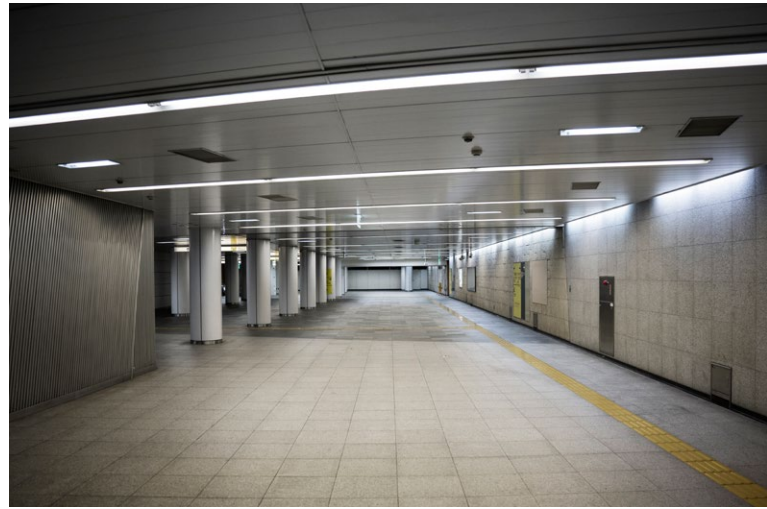

Trasteros

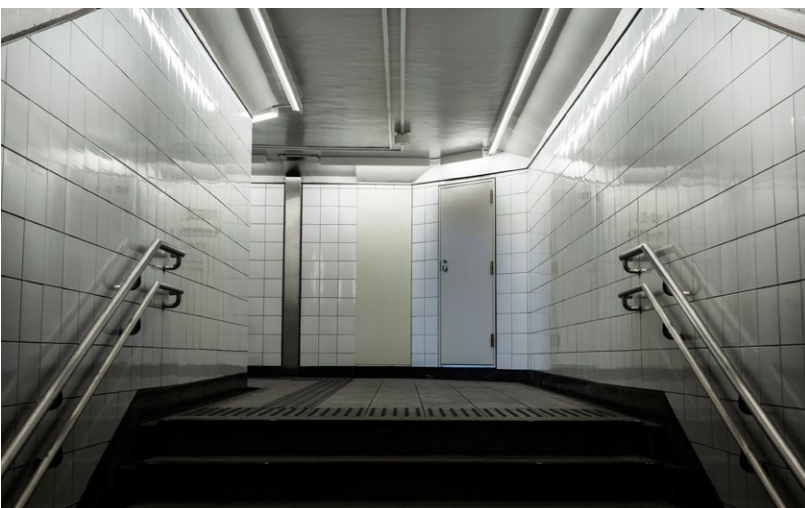

Escaleras



PROGRAMACIÓN HORARIO

16 MODOS

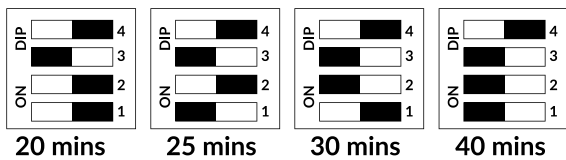
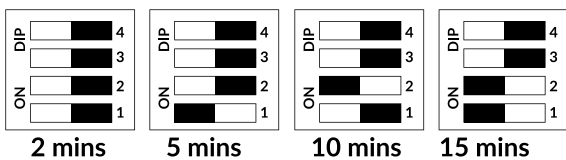

Tenga en cuenta que la barra negra indica la posición del interruptor DIP.

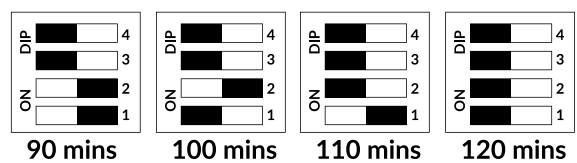
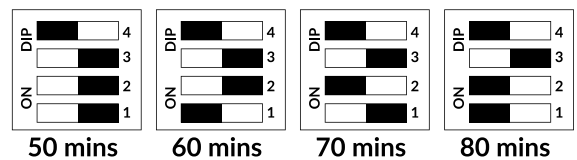

* Todos los datos y precios en catálogo están correctos salvo error tipográfico. **TODOS LOS PRECIOS ESTÁN SUJETOS A MODIFICACIONES.**

ATMOSS[®]



**PEQUEÑO MATERIAL
ELÉCTRICO**

NEW DESIGN

MODERNO Y MINIMALISTA



Botón On/Off
Led indicador

Contactos de bronce

- Alta resistencia a la corrosión.
- Alta dureza.
- Mayor durabilidad.

BASE USB

Tipo A 20w - 2000mA

Tipo C - Carga rápida
18w - 3000mA

Embalaje en
bolsa de pvc



MultiFijación Fijación en pared - superficie



Incluye tornillos y tacos para anclaje en pared

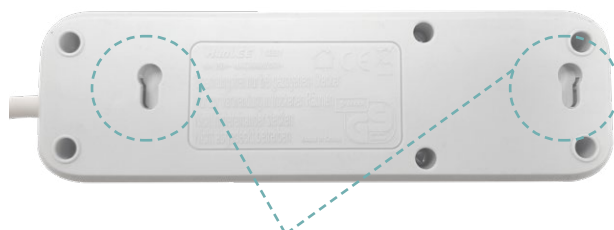
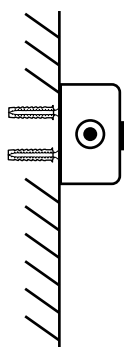
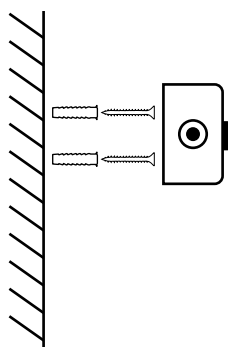

Anclaje para fijación en pared

Botón On/Off

DISEÑO
MINIMALISTA





40 UDS



MTE-0001 - Base 3 tomas

250v - 16A
IP20
Potencia máx: 3680w
Cable: 3 x 1.5mm² - 1.4m

PVPR
14,10€



MTE-0002 - Base 4 tomas

250v - 16A
IP20
Potencia máx: 3680w
Cable: 3 x 1.5mm² - 1.4m

PVPR
15,30€



MTE-0005 - Base 4 tomas + USB

250v - 16A
IP20
Potencia máx: 3680w
Cable: 3 x 1.5mm² - 1.4m
Base USB.

PVPR
41,88€

Base A - 20w - 2000mA
Base C - 18w - 3000mA



MTE-0003 - Base 5 tomas

250v - 16A
IP20
Potencia máx: 3680w
Cable: 3 x 1.5mm² - 1.4m

PVPR
16,50€

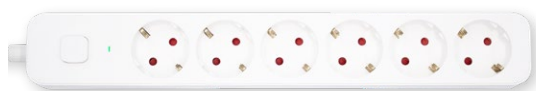

MTE-0004 - Base 6 tomas

250v - 16A
IP20
Potencia máx: 3680w
Cable: 3 x 1.5mm² - 1.4m

PVPR
17,85€

Base de enchufe SIN CABLE

- Tapa desmontable
- Fácil conexión de cables
- Anclaje en pared

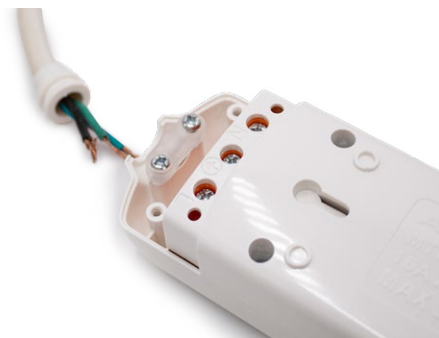

BASE TOMAS SIN CABLE + PROTECCIÓN INFANTIL



SIN CABLE



1UD

MTE-0028 - Base 3 tomas

PVPR

250v - 16A
IP20
Potencia máx: 3680w
Sin Cable

7,47€



MTE-0029 - Base 4 tomas

8,37€

250v - 16A
IP20
Potencia máx: 3680w
Sin Cable

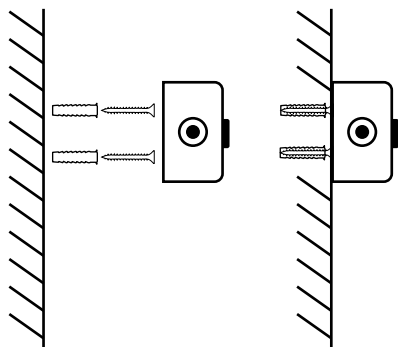

Anclaje para
fijación en pared

Clavija Schuko PLANA



 25 UDS



MTE-0026 - Clavija Schuko macho 4.8mm 16A Marfil

250v - 16A
IP20
Plana

PVPR
2,31€



MTE-0027 - Clavija Schuko macho 4.8mm 16A Negro

250v - 16A
IP20
Plana

2,31€

Haz tu instalación SEGURA en el exterior

IP
44



CLAVIJA SCHUKO GOMA 16A - IMPERMEABLE

10 UDS

PVPR

MTE-0011 - MACHO NEGRO

3,27€

250v - 16A
IP44
Cable 1.5mm²



10 UDS

PVPR

MTE-0021 - HEMBRA NEGRO

4,77€

250v - 16A
IP44
Cable 1.5mm²

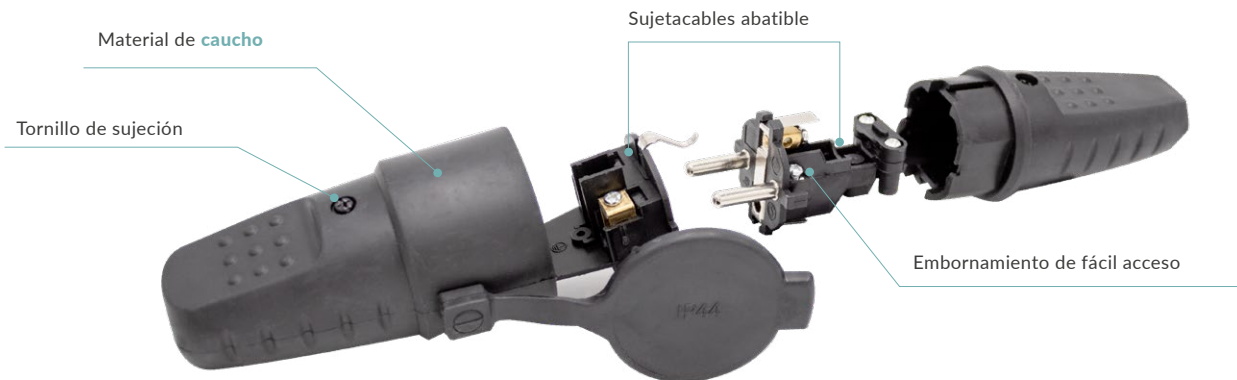

CLAVIJA SCHUKO GOMA 16A

	 25 UDS	PVPR		 25 UDS	PVPR
	MTE-0009 - Macho Negro	2,43€		MTE-0010 - Macho Blanco	2,43€
	250v - 16A IP20			250v - 16A IP20	
	 25 UDS	PVPR		 25 UDS	PVPR
	MTE-0016 - Hembra Negro	3,78€		MTE-0015 - Hembra Blanco	3,78€
	250v - 16A IP20			250v - 16A IP20	

CLAVIJA 4mm 10A 250V PROTECCIÓN INFANTIL



	 25 UDS	PVPR		 25 UDS	PVPR
	MTE-0013 - Hembra Negro	2,07€		MTE-0012 - Hembra Blanco	2,07€
	250v - 10A IP20 4mm			250v - 10A IP20 4mm	
	 50 UDS	PVPR		 50 UDS	PVPR
	MTE-0020 - Macho Negro	1,65€		MTE-0019 - Macho Blanco	1,65€
	250v - 10A IP20 4mm			250v - 10A IP20 4mm	



 10 UDS

PVPR

MTE-0008 - Toma para horno 25A

7,74€

250v - 25A
2P+E
PP Material
IP20



 10 UDS

PVPR

MTE-0014 - Clavija macho para horno 25A

7,02€

250v - 25A
2P+E
PP Material
IP20

ADAPTADOR TOMAS SCHUKO 16A 250V PROTECCIÓN INFANTIL



 10 UDS



MTE-0022 - 3 TOMAS PVPR
250v - 16A 6,60€
IP20
4.8mm



MTE-0023 - 2 TOMAS PVPR
250v - 16A 5,85€
IP20
4.8mm



MTE-0024 - 2 TOMAS PVPR
250v - 16A 4,35€
IP20
4.8mm



MTE-0025 - 3 TOMAS PVPR
250v - 16A 5,82€
IP20
4.8mm

ATMOSS
ELECTRIC

Tarifa PVP 2024



MATERIAL
ELÉCTRICO



Índice

Interrupción Diferenciales	48 - 49
Interrupción Diferenciales rearmable	50
Interrupción Magnetotérmicos	51 - 53
Modelos espacio reducido	54 - 56
Serie COMBI	56-57
Contadores, protectores, relojes de escalera	58 - 59
Reloj modular, reloj astronómico, Medidor energía, Interrupción WIFI, Dispositivo de protección transitorio y permanente WIFI	60-63
Cajas de distribución	64-65
Reloj mecánico, digital	66
Fichas conexión rápida	67
Regletas de conexión	68-69
Bridas	70-71

Protección residencial

¡ La **SEGURIDAD** de las personas garantizada !

DIFERENCIALES

6KA / 10KA / SUPERINMUNIZADO / SUPERINMUNIZADO REARMABLE

2 POLOS - 6ka - TIPO AC   1 UDS 



REF		PVPR
200-DIF010	25A 6ka 30mA	23,70 €
200-DIF011	40A 6ka 30mA	23,70 €
200-DIF012	63A 6ka 30mA	40,77 €
200-DIF013	25A 6ka 300mA	30,12 €
200-DIF014	40A 6ka 300mA	31,32 €
200-DIF015	63A 6ka 300mA	40,77 €

2 POLOS - 10ka - TIPO AC   1 UDS 

REF		PVPR
100-DIF0005	63A 10ka 30mA	43,86 €
100-DIF0036	40A 10ka 30mA	47,37 €

Interruptor Diferencial Especial Zona Agua

Especialmente fabricado para protegernos contra las corrientes residuales en nuestra bañera, jacuzzi, piscina, sauna o cualquier zona húmeda.

Es especial por tener una **ALTA SENSIBILIDAD DE 10mA**,



2 POLOS - 6ka - TIPO AC   1 UDS 

100-DIF029	25A 6ka 10mA	53,43 €
------------	--------------	---------

4 POLOS - 6ka - TIPO AC   1 UDS 

REF		PVPR
200-DIF018	25A 6ka 30mA	46,08 €
200-DIF019	40A 6ka 30mA	46,08 €
200-DIF020	63A 6ka 30mA	47,37 €
200-DIF021	25A 6ka 300mA	46,08 €
200-DIF022	40A 6ka 300mA	46,08 €
200-DIF023	63A 6ka 300mA	47,37 €

4 POLOS - 10ka - TIPO AC   3 UDS 



REF		PVPR
102-DIF0010	25A 10ka 30mA	51,96 €
102-DIF0011	40A 10ka 30mA	51,96 €
102-DIF0012	63A 10ka 30mA	51,96 €
102-DIF0007	80A 10ka 30mA	67,98 €
102-DIF0008	100A 10ka 30mA	74,79 €

101-DIF000001	25A 10ka 300mA	51,78 €
101-DIF000003	63A 10ka 300mA	57,93 €
101-DIF000004	80A 10ka 300mA	67,98 €
101-DIF000005	100A 10ka 300mA	74,79 €

* Todos los datos y precios en catálogo están correctos salvo error tipográfico.
TODOS LOS PRECIOS ESTÁN SUJETOS A MODIFICACIONES.

Evita los cortes intempestivos
MAYOR SENSIBILIDAD





Diferencial **Superinmunizados**

2 POLOS - 6kA - TIPO A   1 UDS 

REF		PVPR
200-DIF027	16A 6kA 30mA	42,90 €
200-DIF016	40A 6kA 30mA	46,08 €
200-DIF028	63A 6kA 30mA	50,46 €

200-DIF017 40A 6kA 300mA 46,08 €

2 POLOS - 10kA - TIPO A   1 UDS 

100-DIF023	80A 10kA 30mA	68,13 €
100-DIF025	100A 10kA 30mA	81,78 €

100-DIF018	63A 10kA 300mA	67,98 €
100-DIF024	80A 10kA 300mA	68,13 €
100-DIF026	100A 10kA 300mA	81,78 €

4 POLOS - 6kA - TIPO A   1 UDS 

200-DIF024	40A 6kA 30mA	59,07 €
200-DIF026	63A 6kA 30mA	67,98 €

200-DIF025	40A 6kA 300mA	59,07 €
200-DIF029	63A 6kA 300mA	63,48 €

4 POLOS - 10kA - TIPO A   1 UDS 

100-DIF019	80A 10kA 30mA	74,40 €
100-DIF021	100A 10kA 30mA	81,78 €
100-DIF037	125A 10kA 30mA	144,36 €

100-DIF015	63A 10kA 300mA	67,98 €
100-DIF020	80A 10kA 300mA	74,40 €
100-DIF022	100A 10kA 300mA	81,78 €
100-DIF038	125A 10kA 300mA	144,36 €



Funcionamiento del diferencial



El indicador siempre estará en blanco, salvo cuando detecta una fuga de corriente residual.

Todos nuestros diferenciales, vienen marcados por normativa en la maneta con ON - OFF



El diferencial se dispara cuando detecta una fuga de corriente residual y aparece el indicador en rojo como se muestra en la imagen.

Cuando se pulsa el boton Test  se puede comprobar la fuga de corriente y el indicador se muestra en rojo.

Para ver el funcionamiento clicar sobre la flecha azul



Protección residencial

¡ La **SEGURIDAD** de las personas garantizada !





Protección residencial

¡ Tu HOGAR o FÁBRICA mejor protegido !



DIFERENCIALES REARMABLE

REARMABLE / SUPERINMUNIZADO REARMABLE



· Rearmable superinmunizado 2P

2 POLOS - 6kA - TIPO A

1 UDS



100-DIF030	40A	6kA	30mA	193,62 €
100-DIF031	40A	6kA	300mA	193,62 €

2 POLOS - 10kA - TIPO A



100-DIF040	40A	10kA	30mA	193,62 €
100-DIF027	40A	10kA	300mA	258,90 €



· Rearmable superinmunizado 4P

4 POLOS - 6kA - TIPO A

1 UDS



100-DIF033	40A	6kA	300mA	216,36 €
------------	-----	-----	-------	----------

4 POLOS - 10kA - TIPO A



100-DIF028	40A	10kA	300mA	306,63 €
100-DIF041	40A	10kA	30mA	221,70 €



· Diferencial Rearmable 4P 10kA

4 POLOS - 10kA - TIPO AC



1 UDS



100-DIF009	40A	10kA	30mA	306,63 €
------------	-----	------	------	----------

* Todos los datos y precios en catálogo están correctos salvo error tipográfico.
TODOS LOS PRECIOS ESTÁN SUJETOS A MODIFICACIONES.

INTERRUPTORES MAGNETOTÉRMICOS

Especial **SERIE - 6kA**



1 POLO - 6kA - Curva C 12 UDS

REF		PVPR
200-MAG021	6A 6kA	4,44 €
200-MAG018	10A 6kA	6,45 €

1 P+N - 6kA - Curva C 6 UDS

REF		PVPR
200-MAG001	6A 6kA	5,43 €
200-MAG004	20A 6kA	5,43 €
200-MAG005	32A 6kA	5,43 €
200-MAG006	40A 6kA	6,15 €
200-MAG007	50A 6kA	6,15 €
200-MAG008	63A 6kA	6,15 €



2P - 6kA - Curva C 6 UDS

REF		PVPR
200-MAG022	6A 6kA	6,45 €
200-MAG023	10A 6kA	6,45 €
200-MAG024	16A 6kA	6,45 €
200-MAG025	20A 6kA	6,45 €
200-MAG026	25A 6kA	6,45 €
200-MAG027	32A 6kA	6,96 €
200-MAG028	40A 6kA	7,62 €
200-MAG029	50A 6kA	9,39 €
200-MAG030	63A 6kA	9,39 €

4P - 6kA - Curva C 3 UDS

REF		PVPR
200-MAG010	6A 6kA	20,28 €
200-MAG011	10A 6kA	20,28 €
200-MAG012	16A 6kA	20,28 €
200-MAG013	20A 6kA	20,28 €
200-MAG019	25A 6kA	20,28 €
200-MAG014	32A 6kA	20,28 €
200-MAG015	40A 6kA	20,28 €
200-MAG016	50A 6kA	20,28 €
200-MAG017	63A 6kA	20,28 €



Protección residencial

Tu **HOGAR** o **FÁBRICA**
mejor protegido!

* Todos los datos y precios en catálogo están correctos salvo error tipográfico.
TODOS LOS PRECIOS ESTÁN SUJETOS A MODIFICACIONES.

INTERRUPTORES MAGNETOTÉRMICOS

Especial **SERIE - 10kA**

Protección industria

¡ Tu **FÁBRICA**
con mejor seguridad !

1 POLO - 10kA - Curva C

12 UDS



REF		PVPR
100-MAG0016	6A 10kA	6,75 €
100-MAG0007	10A 10kA	6,75 €
100-MAG0008	16A 10kA	6,75 €
100-MAG0009	20A 10kA	6,75 €
100-MAG0010	25A 10kA	6,75 €
100-MAG0011	32A 10kA	6,75 €
100-MAG0012	40A 10kA	6,75 €
100-MAG0019	63A 10kA	8,55 €

2 POLOS - 10kA - Curva C

6 UDS



REF		PVPR
100-MAG0013	6A 10kA	11,82 €
100-MAG0001	10A 10kA	11,82 €
100-MAG0002	16A 10kA	11,82 €
100-MAG0003	20A 10kA	11,82 €
100-MAG0004	25A 10kA	11,82 €
100-MAG0005	32A 10kA	11,82 €
100-MAG0006	40A 10kA	11,82 €
100-MAG0017	50A 10kA	13,44 €
100-MAG0018	63A 10kA	16,89 €

3 POLOS - 10kA - Curva C

4 UDS



REF		PVPR
000-MAG0001	10A 10kA	24,54 €
000-MAG0002	16A 10kA	24,54 €
000-MAG0008	20A 10kA	24,54 €
000-MAG0003	25A 10kA	24,54 €
000-MAG0004	32A 10kA	24,54 €
000-MAG0005	40A 10kA	24,54 €
000-MAG0006	50A 10kA	24,54 €
000-MAG0007	63A 10kA	24,54 €

3 POLOS - 10kA - Curva D

4 UDS



REF		PVPR
000-MAG0027	10A 10kA	33,90 €
000-MAG0028	16A 10kA	33,90 €
000-MAG0029	20A 10kA	33,90 €
000-MAG0030	25A 10kA	33,90 €
000-MAG0031	32A 10kA	33,90 €
000-MAG0032	40A 10kA	33,90 €
000-MAG0033	50A 10kA	33,90 €
000-MAG0034	63A 10kA	33,90 €

* Todos los datos y precios en catálogo están correctos salvo error tipográfico.
TODOS LOS PRECIOS ESTÁN SUJETOS A MODIFICACIONES.

INTERRUPTORES MAGNETOTÉRMICOS

Especial **SERIE - 10kA**



4 POLOS - 10kA - Curva C  3 UDS 

REF		PVPR
101-MAG0009	6A 10kA	30,00 €
101-MAG0001	10A 10kA	30,00 €
101-MAG0002	16A 10kA	30,00 €
101-MAG0003	20A 10kA	30,00 €
101-MAG0004	25A 10kA	30,00 €
101-MAG0005	32A 10kA	30,00 €
101-MAG0006	40A 10kA	30,00 €
101-MAG0007	50A 10kA	30,00 €
101-MAG0008	63A 10kA	30,00 €

4 POLOS - 10kA - Curva D  3 UDS 

REF		PVPR
104-MAG0018	10A 10kA	33,90 €
104-MAG0019	16A 10kA	33,90 €
104-MAG0020	20A 10kA	33,90 €
104-MAG0021	25A 10kA	33,90 €
104-MAG0022	32A 10kA	37,50 €
104-MAG0023	40A 10kA	37,50 €
104-MAG0024	50A 10kA	37,50 €
104-MAG0025	63A 10kA	37,50 €
104-MAG0026	100A 10kA	37,50 €

Especial **SERIE - 15kA**



4 POLOS - 15kA - Curva D  3 UDS 

REF		PVPR
101-MAG0010	80A 15kA	140,37 €
101-MAG0011	100A 15kA	157,92 €
101-MAG0012	125A 15kA	175,47 €

Protección industria

¡ Tu **FÁBRICA**
con mejor seguridad!

AHORRA ESPACIO, hasta un 50% más en tú instalación

SERIE REDUCIDA

con los nuevos modelos de espacio reducido

EJEMPLO DE INSTALACIÓN DE VIVIENDA DE 50 A 20CM

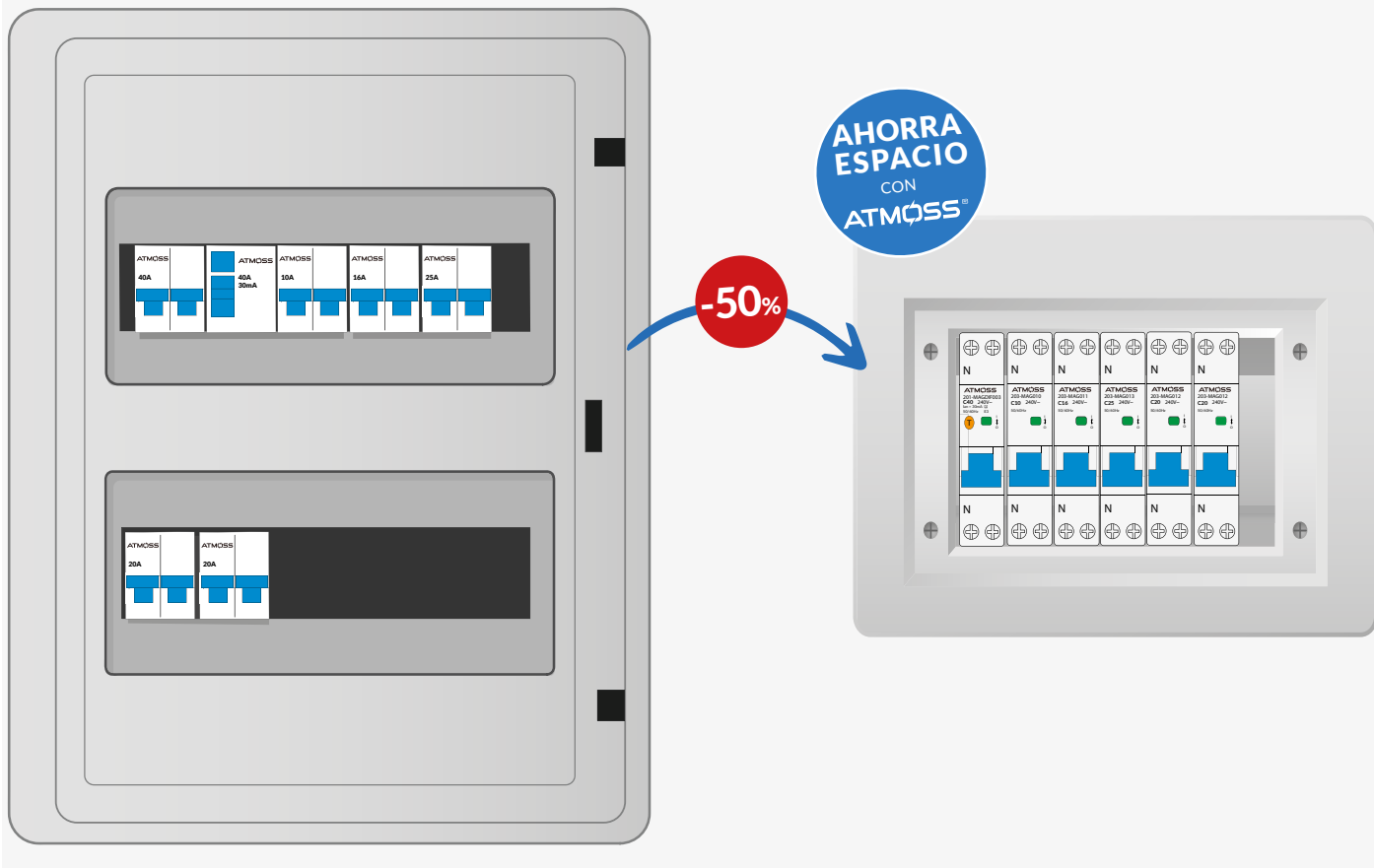

Ejemplo de instalación de vivienda:



MAGNETOTÉRMICO GENERAL
2P 40A - 6kA - Curva C
200-MAG028

NEW!



Magnetotérmico general + Diferencial
1P+N 40A - 6kA 30mA
Curva C
201-MAGDIF003



DIFERENCIAL
2P 40A - 6kA - TIPO AC
200-DIF011

PEQUEÑO INTERRUPTOR AUTOMÁTICO PIAS



200-MAG023 - 10A
200-MAG024 - 16A
200-MAG026 - 25A
200-MAG025 - 20A

NEW!



203-MAG010 - 10A
203-MAG011 - 16A
203-MAG013 - 25A
203-MAG012 - 20A

Protectores para espacio reducido

Interruptores automáticos compactos.

Esta serie de interruptores compactos se presenta en las siguientes combinaciones de polos 1P+N en 1 módulos, 2P en 1 módulo, 3P y 4P en 2 módulos; con un poder de corte que va desde los 6 hasta los 10kA. Estas características le permiten cubrir aplicaciones tanto residenciales como industriales.

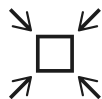

Solución compacta



Fácil de instalar



Versátil



18mm

MAGNETOTÉRMICOS REDUCIDOS



1P+N - 6kA DPN Curva C

12 UDS

2POLOS EN
1 MÓDULO

REF

PVPR

103-MAG0007	6A DPN 6kA	10,05 €
103-MAG0001	10A DPN 6kA	10,05 €
103-MAG0002	16A DPN 6kA	10,05 €
103-MAG0003	20A DPN 6kA	10,05 €
103-MAG0004	25A DPN 6kA	10,05 €
103-MAG0005	32A DPN 6kA	10,89 €
103-MAG0006	40A DPN 6kA	10,89 €



1P+N - 6kA DPN SET - Curva C

12 UDS

2POLOS EN
1 MÓDULO

REF

PVPR

203-MAG010	10A DPN SET 6kA	10,05 €
203-MAG011	16A DPN SET 6kA	10,05 €
203-MAG012	20A DPN SET 6kA	10,05 €
203-MAG013	25A DPN SET 6kA	10,05 €
203-MAG014	32A DPN SET 6kA	10,89 €
203-MAG015	40A DPN SET 6kA	10,89 €

MAGNETOTÉRMICOS REDUCIDOS



4P - 6kA - Curva C

6 UDS

4POLOS EN
2 MÓDULOS

REF

PVPR

200-MAG031	10A 6kA	86,94 €
200-MAG032	16A 6kA	86,94 €
200-MAG033	20A 6kA	86,94 €
200-MAG034	25A 6kA	86,94 €
200-MAG035	32A 6kA	86,94 €
200-MAG036	40A 6kA	86,94 €

* Todos los datos y precios en catálogo están correctos salvo error tipográfico.
TODOS LOS PRECIOS ESTÁN SUJETOS A MODIFICACIONES.



**2POLOS EN
1 MÓDULO**

1 UDS



Diferencial Superinmunizado Tipo A
IP + N - Tipo A



REF				PVPR
100-DIF034	40A	10kA	30mA	50,58 €
100-DIF039	16A	6kA	10mA	53,40 €

**4POLOS EN
2 MÓDULOS**

1 UDS



Diferencial Superinmunizado Tipo A
3P + N - Tipo A - 2MÓDULOS



REF				PVPR
100-DIF035	40A	10kA	30mA	125,61 €



* Con enclavamiento para candado.

SERIE COMBI VIGI

SERIE COMBI

**2POLOS EN
1 MÓDULO**

NEW!



Magneto Diferencial Superinmunizado Tipo A
IP+N - 6kA 30mA - Curva C



REF			PVPR
201-MAGDIF001	16A	6kA	42,90 €
201-MAGDIF002	25A	6kA	42,90 €
201-MAGDIF003	40A	6kA	47,58 €

2 MÓDULOS

NEW!



Magneto Diferencial Superinmunizado Tipo A
IP+N - 10kA 30mA - Curva C



REF			PVPR
101-MGDIF0008	10A	10kA	67,20 €
101-MGDIF0009	16A	10kA	67,20 €
101-MGDIF0010	25A	10kA	67,20 €

2 MÓDULOS

Magneto Diferencial Tipo AC



2P - 30mA - Curva C



REF			PVPR
101-MGDIF0002	16A	30mA	52,47 €
101-MGDIF0003	20A	30mA	52,47 €
101-MGDIF0004	25A	30mA	52,47 €
101-MGDIF0007	32A	30mA	52,47 €
101-MGDIF0006	40A	30mA	55,98 €

* Todos los datos y precios en catálogo están correctos salvo error tipográfico.
TODOS LOS PRECIOS ESTÁN SUJETOS A MODIFICACIONES.

MAGNETOTÉRMICO CON PROTECTOR COMBINADO SOBRETENSIÓN TRANSITORIO Y PERMANENTE

PROTEGE TUS INSTALACIONES DE
SOBRETENSIONES Y CAIDAS DE RAYOS



2P - 3MÓDULOS

1 UDS



REF

PVPR

PRT-005 2P 40A 10KA

79,17 €



4P - 6MÓDULOS

1 UDS



REF

PVPR

PRT-006 4P 40A 10KA

123,69 €

NORMA: EN50550 / IEC61643-1 / IEC60898-1.

LVD 2014/35/EU
ROHS 2011/65/EU

- Tiempo de actuación contra sobretensiones permanentes

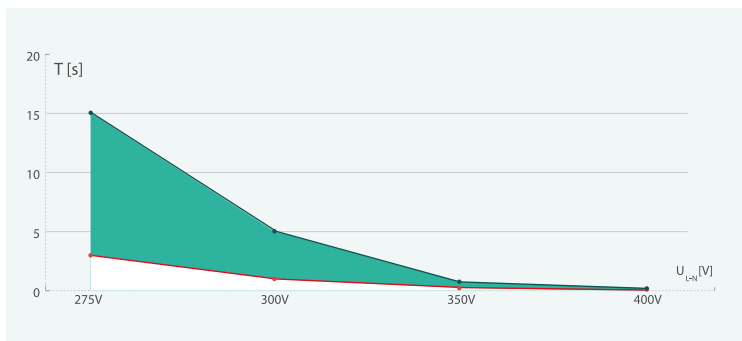

Curva de tensión / tiempo según normativa UNE-EN-50550

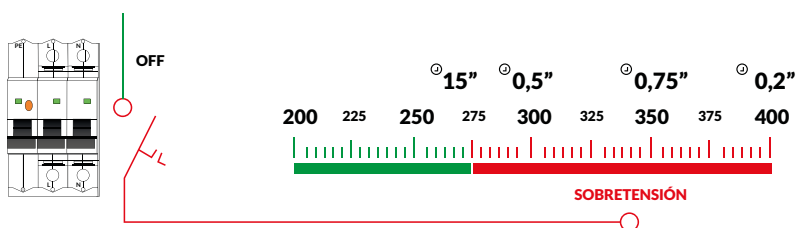
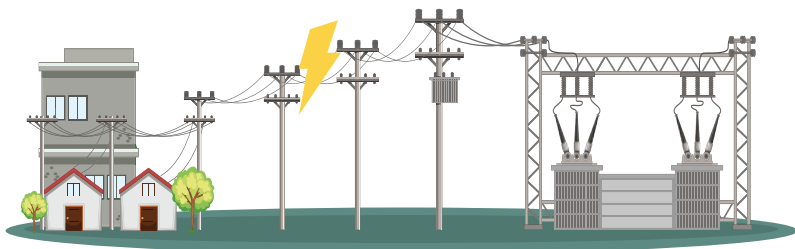

* Todos los datos y precios en catálogo están correctos salvo error tipográfico.
TODOS LOS PRECIOS ESTÁN SUJETOS A MODIFICACIONES.



● Protector sobretensión transitorias

**Protector sobretensión
2 POLOS**

 2 UDS

DESCARGAR
FICHA TECNICA



PRT-001
PROTECTOR CONTRA
SOBRETENSIONES TRANSITORIAS

C2-40KA/275V 1P+NPE

PVPR 36,81 €

**Protector sobretensión
4 POLOS**

 1 UDS

DESCARGAR
FICHA TECNICA



PRT-002
PROTECTOR CONTRA
SOBRETENSIONES TRANSITORIAS

C2-40KA/400V 3P+NPE

PVPR 67,89 €

● Protectores

Protector permanente Max y Mín

 8 UDS

DESCARGAR
FICHA TECNICA



100-BOB003
PROTECTOR PERMANENTE BOBINA
DE MÁXIMA Y MÍNIMA 230V
para MAG 10KA

PVPR 35,94 €

Bobina de tensión - Protección tensión max

100-BOB001

100-BOB002

TIPO AC 230V -4M

TIPO AC 400V -7M

PVPR 55,80 €

PVPR 107,88 €

● Reloj modular

Reloj modular

 1 UDS

DESCARGAR
FICHA TECNICA



RLJ-001
RELOJ MODULAR CON RESERVA

PVPR 39,57 €

● Minutero escalera

Minutero escalera

 1 UDS

DESCARGAR
FICHA TECNICA



RLJ-003
MINUTERO ESCALERA CON INDICADOR LED

PVPR 35,94 €

● **Accesorios**



Base de enchufe SCHUKO

6 UDS

DESCARGAR
 FICHA TECNICA

106-BASE001

BASE DE ENCHUFE DE CARRIL DIN SCHUKO 16A

PVPR 6,81 €

● **Interruptor - conmutador**



Interruptor - Conmutador Carril DIN

1 UDS

DESCARGAR
 FICHA TECNICA

INT-001

1P 25A

PVPR 8,85 €

● **Contactores modular**



Contactador modular 2 POLOS

DESCARGAR
 FICHA TECNICA

105-CON002

2P
25 A

PVPR 18,84 €

12 UDS

105-CON003

2P
40 A

PVPR 33,63 €

6 UDS

105-CON009

2P
63 A

PVPR 33,63 €

6 UDS



Contactador modular 4 POLOS

DESCARGAR
 FICHA TECNICA

105-CON004

4P
25 A

PVPR 47,34 €

6 UDS

105-CON005

4P
40 A

PVPR 47,34 €

4 UDS

105-CON006

4P
63 A

PVPR 47,34 €

4 UDS

● Reloj modular 

El reloj modular se presenta como el **programador ideal para la semana**, aplicaciones estacionarias o que necesitan variar su horario de funcionamiento a lo largo del año,...

NEW!



Reloj modular digital 

RLI-005
RELOJ CON RESERVA
1 CANAL - 16A

PVPR 49,14 €

 1 UDS

Dispone de:

 Interruptor horario digital con programa semanal

 Batería de litio 3.6V, 1.2Ah

 52 Programas

 Cambio automático de horario Verano/Invierno

 Pantalla LCD retroiluminada

 Modo vacaciones

NEW!



Reloj modular digital

RLI-006
RELOJ CON RESERVA
2 CANALES - 16A

PVPR 55,65 €

 1 UDS

● Reloj astronómico 

El reloj **calcula automáticamente la hora de salida y de puesta del sol** en función de la posición geográfica en la que está ubicado. Esto nos permite ahorrar energía en tu instalación.

NEW!



Reloj astronómico digital 

RLI-009
RELOJ DIGITAL CON RESERVA
1 CANAL - 16A

PVPR 55,65 €

 1 UDS

Dispone de:

 Programador astronómico y programador anual/semanal

 Reserva de marcha 10 años (batería de litio)

 80 programas

 Tapa precintable, fácil configuración con 4 botones

 Cambio automático de horario de verano/invierno

 Pantalla LCD con retroiluminación (puede desactivarse)

 Modo vacaciones

 Modo aleatorio

2CH 2 canales puede asignarse un programa individual a cada canal

 Montaje en carril din, 2 módulos

NEW!



Reloj astronómico digital 

RLI-007
RELOJ DIGITAL CON RESERVA
2 CANALES - 16A

PVPR 63 €

 1 UDS

NEW!



Reloj astronómico WiFi 

RLI-008
RELOJ WiFi CON RESERVA
1 CANAL - 16A

PVPR 50,55 €

 1 UDS

● **Medidor de energía** ⚡



Medidor de energía

1 UDS



MED-001

Medidor de energía 1P 220V CON LUZ

PVPR 35,10 €

- Gran fiabilidad
- Peso ligero
- Pequeño volumen
- La cáscara está hecha de material ignífugo de nylon con alta resistencia al fuego y aislamiento duradero
- Instalación en carril DIN 35mm

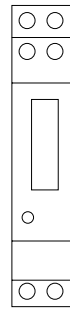

18mm

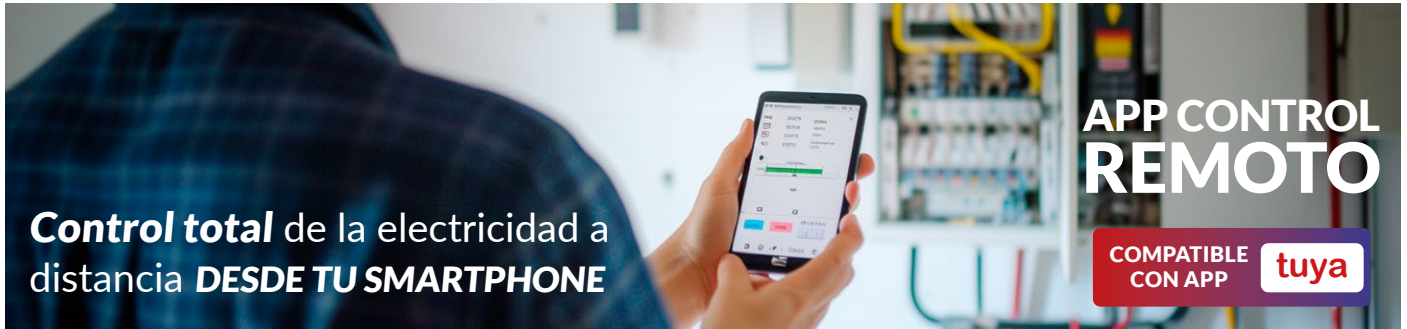

Control total de la electricidad a distancia **DESDE TU SMARTPHONE**

APP CONTROL REMOTO

COMPATIBLE CON APP **tuya**

● **Interruptor medidor 2P WiFi** 📶



INT-002

Interruptor medidor Smart Wifi 2P WiFi 63A

PVPR 78,60 €

1 UDS

Características:



- **Control inalámbrico:** Control desde APP smartphone
- **Temporización:** On / Off
- **Compartir control**
- **Protección de corriente residual**
- **Función de medición:** Puede mostrar voltaje, corriente, potencia, electricidad.
- **Crear escenas**
- Instalación en **Carril DIN**

Inicio

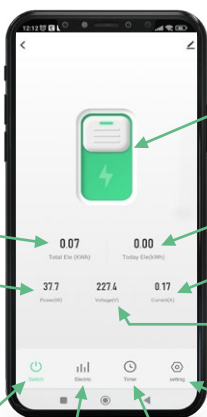

- On / Off
- Kwh Diarios
- Corriente (A)
- Voltaje (V)
- Ajustes
- Historial
- Programación
- Switch On/Off
- Total Kwh
- Potencia (w)

Estadísticas



Programación

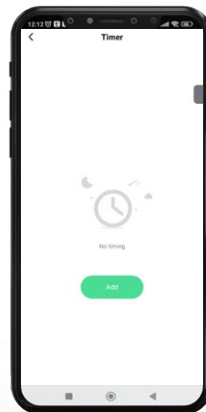

Ajustes Programación

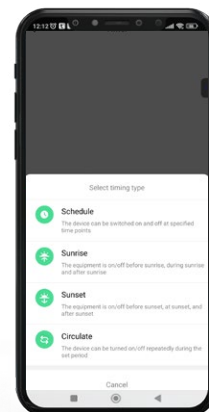

Ajustes

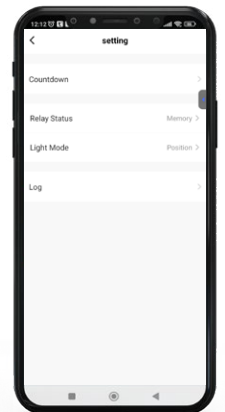

Ajustes Programación

- **Horario:** El dispositivo puede encenderse y apagarse en momentos determinados.
- **Amanecer:** El equipo se enciende/apaga antes del amanecer, durante el amanecer y después del amanecer.
- **Atardecer:** El equipo está encendido/apagado antes del atardecer, durante el atardecer y después del atardecer.
- **Circular:** El equipo puede encenderse/apagarse repetidamente durante el periodo establecido.

LA ENERGÍA EN TUS MANOS

Importante activar para la vinculación rápida



Dispositivo **10 en 1**

VIDEO VINCULACIÓN

ESCANEAR FICHA TÉCNICA

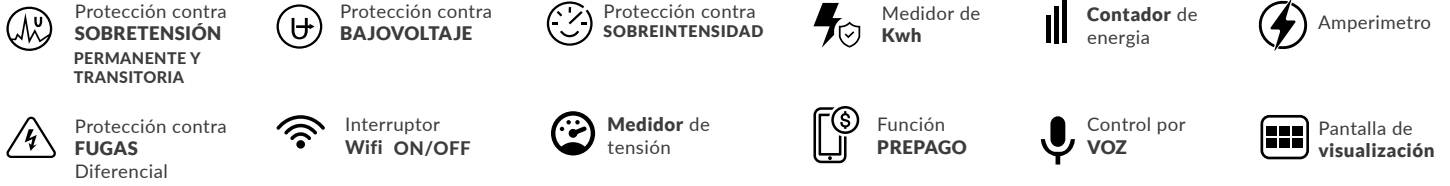

MED-002

Dispositivo de protección ajustable de tensión (PERMANENTE Y TRANSITORIA), corriente, y fugas con contador de kilovatios hora.

PVPR 64,29€

- El valor de **protección contra permanentes y transitorias** para ajustarlo usted mismo.
- **Protección contra sobrecorriente** configurable por el usuario.
- La **protección contra fugas** la puede ajustar usted mismo.
- Visualización en **tiempo real** de la **potencia**.
- Función **prepago**.
- Control por **voz**
- Programa **horarios**
- Mide el **consumo** de tu vivienda vacacional o alquiler desde el **Check-in y Check-out**
- **Función autoencendido**. El dispositivo se restablece automáticamente.



Funciones

Parámetros técnicos

	Voltaje	85-300 V
	Vida eléctrica y mecánica	≤10.000 ciclos
	Valor de protección contra sobretensión	120-300 V REGULABLE DEFECTO 275 V
	Valor de protección contra subtensión	85-200 V REGULABLE DEFECTO 160V
	Valor de protección contra fugas	10-99m A REGULABLE DEFECTO 30mA

Funciones

Parámetros técnicos

	Dimensiones	100*36mm
	Valor de protección contra sobreintensidad	1-63A REGULABLE
	Tiempo de acción	<15
	Consumo de energía	<2w

FUNCIÓN PREPAGO



- Puedes controlar el consumo de tu vivienda desde tu smartphone.
- Limitar el consumo.
- Activar o desactivar la electricidad.

Uso ideal para:

- Hoteles
- Alquiler vacacional
- Alquiler vivienda
- Carga de coches
- Trasteros



Esquema eléctrico

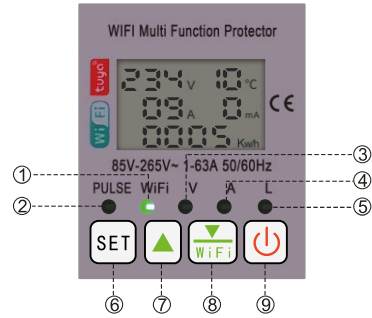
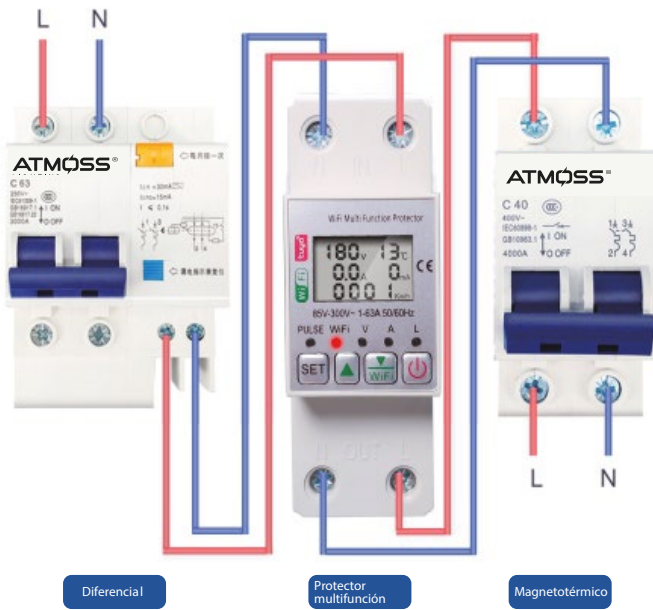

1. Indicador WIFI
2. Indicador de pulso del contador de kilovatios hora
3. Indicador de alarma de sobretensión/subtensión
4. Indicador de alarma de sobreintensidad
5. Indicador de alarma de fuga
6. Tecla Set: pulse para acceder a la interfaz de configuración
7. Tecla de ajuste +
Tecla Test: Pulsación prolongada durante 3 segundos para comprobar la fuga
8. Tecla de ajuste -
Tecla Wifi: Pulsación larga durante 5 segundos para configurar el Wifi
9. Tecla ON/OFF

Tiempo de disparo según la norma **UNE-EN-5050**

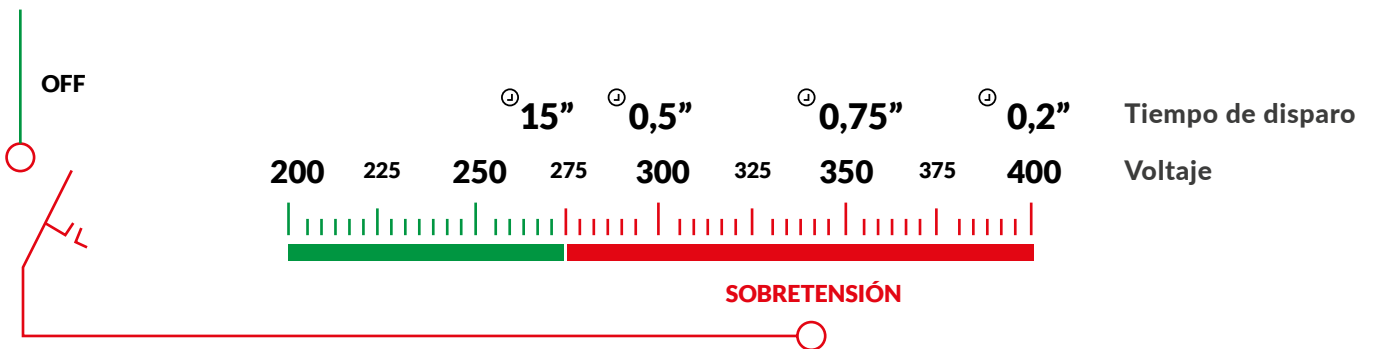

Funciones

- Consumo de potencia
- Ajusta la Temperatura
- Automatizaciones
- Programa horarios
- Monitorización energética
- Ajustar valores

* Todos los datos y precios en catálogo están correctos salvo error tipográfico. **TODOS LOS PRECIOS ESTÁN SUJETOS A MODIFICACIONES.**

Cajas de distribución estancas de superficie

IP65 - GRIS

IP40 - BLANCO

 1 UDS

DESCARGAR
FICHA TÉCNICA



Color

Mantiene su color a lo largo del tiempo al aire libre

Resistencia

Gran resistencia al aire libre, gracias a su protección y material ABS. Este material destaca por sus propiedades mecánicas y su capacidad para resistir impactos.

Agrietamiento

Resiste el agrietamiento por tensión ambiental, alcoholes y muchos agentes de limpieza.

No poroso

Evita que se fijen mohos, musgos, etc en la caja.



IP65 - Gris

PVPR

IP40 - Blanco

PVPR



BOX-001 - 3 MÓDULOS

9,12 €



BOX-007 - 6 MÓDULOS

11,85 €



BOX-002 - 5 MÓDULOS

11,46 €



BOX-008 - 8 MÓDULOS

16,02 €



BOX-003 - 8 MÓDULOS

14,58 €



BOX-009 - 12 MÓDULOS

21,54 €



BOX-004 - 12 MÓDULOS

26,10 €



BOX-010 - 16 MÓDULOS

25,74 €



BOX-005 - 18 MÓDULOS

65,70 €



BOX-011 - 24 MÓDULOS

40,50 €



BOX-006 - 24 MÓDULOS

84,42 €



BOX-012 - 36 MÓDULOS

54,48 €

● Reloj temporizador mecánico



Reloj temporizador

RLJ-004

Reloj temporizador mecánico blanco

PVPR 10,56 €



1 UDS



Reloj temporizador exterior IP44

RLJ-012

Reloj temporizador mecánico blanco exterior

1 UDS



Reloj temporizador

RLJ-010

Reloj temporizador mecánico mini blanco

1 UDS

● Reloj temporizador digital



Reloj temporizador digital

RLJ-011

Reloj temporizador semanal digital

1 UDS

DESCARGAR VIDEO

REGLETAS Y CONECTOR

CONEXIÓN RÁPIDA

Grado de protección

Inflamabilidad: UL94-V2

Materiales

Polycarbonato PC



DESCARGAR
FICHA TÉCNICA

Descripción:

Conecta rápida y fácilmente entre sí todo tipo de cables de diferentes tamaños hasta 4mm². Cuenta con un orificio de testeo en la parte frontal para un control óptimo de la conectividad. Puede combinar cables de distintas secciones, rígidos o flexibles, de entre 0,2 y 4 mm²

NEW!

Regleta de conexión rápida

REF

UDS

PVPR



Regleta de conexión rápida **4mm 1P** FCH-026 50 **20,10 €**

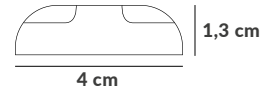

Regleta de conexión rápida **4mm 2P** FCH-027 50 **20,94 €**

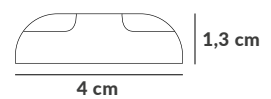
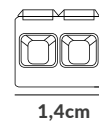

Regleta de conexión rápida **4mm 3P** FCH-028 50 **32,94 €**

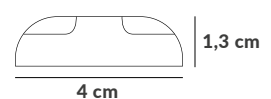
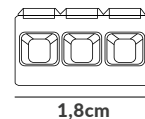

Conector rápido universal

REF

PVPR



Conector rápido universal **4mm 2P** FCH-029 100 **28,20 €**

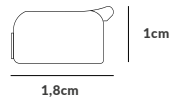
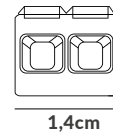

Conector rápido universal **4mm 3P** FCH-030 100 **32,88 €**

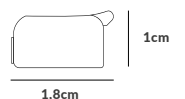
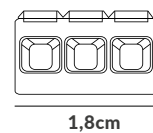

Conector rápido universal **4mm 5P** FCH-031 50 **24,60 €**

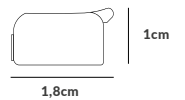
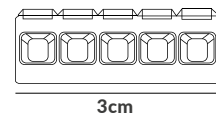

Conecta los cables de manera
RÁPIDA y FÁCIL



Conexión sin necesidad de:



- Empalmes



- Cinta adhesiva



- Soldar

REGLETAS DE CONEXIÓN

de polipropileno retardante abocardadas en ambos lados de color blanco y negro, con una máxima resistencia mecánica y seguridad eléctrica.



Materiales

Polipropileno PP retardante T110°C
 Inserciones de acero.
 Tornillos de acero cincado.
 Temperatura de trabajo
 -40°C a +80°C

Norma, certificados y materiales



UNE20315-2-5:2018
 2011/65/UE/ROHS



Se han diseñado para adaptarse a las necesidades de instalación del profesional eléctrico, cuentan con un sistema de **corte fácil**, que permite una separación de polos sin aristas para una total seguridad durante la manipulación.

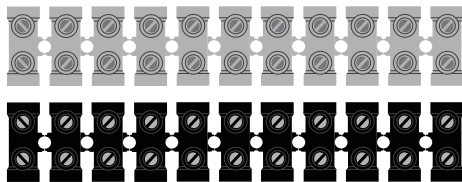

Regletas **más seguras** y **más cómodas** sin la necesidad de herramientas de corte.

Colores: Blanco y negro

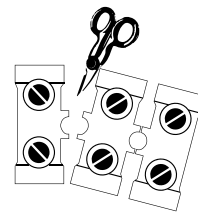
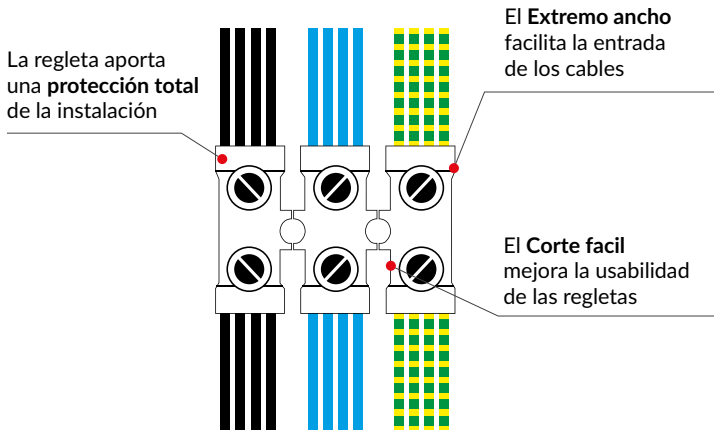

Otras marcas

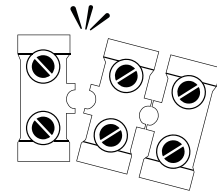

Regleta Atmosm

Corte fácil

El **corte es más sencillo** y fácil, sin necesidad de utilizar herramientas de corte. Dejando el borde sin aristas.

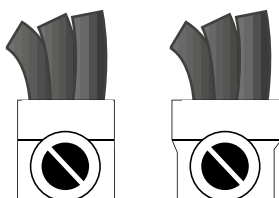

Otras marcas

Regleta Atmosm

Abertura más ancha

Las regletas tienen la **abertura más ancha** para facilitar la entrada de los cables, a diferencia de otras marcas que tienen la entrada más estrecha.



Otras marcas



Regleta Atmosm

Tornillo imperdible

El tornillo no se desprende al desatornillar.

Regletas de conexión 450V IGNÍFUGO T110°C

Norma, certificados y materiales



Materiales

Regletas de Polipropileno retardante T110°C
 Inserciones de acero.
 Tornillos de acero cincado.
 Temperatura de trabajo
 -40°C a +80°C

UNE20315-2-5:2018
 2011/65/UE/ROHS

DESCARGAR
 FICHA TÉCNICA

10 UDS en blister plastificado



Sección: **6mm²**

1000 uds/caja

REF

PVPR

Regleta de conexión para cable eléctrico	6mm²	Blanco	FCH-006-B	0,87 €
Regleta de conexión para cable eléctrico	6mm²	Negro	FCH-006-N	0,87 €



Sección: **10mm²**

500 uds/caja

REF

PVPR

Regleta de conexión para cable eléctrico	10mm²	Blanco	FCH-0010-B	1,08 €
Regleta de conexión para cable eléctrico	10mm²	Negro	FCH-0010-N	1,08 €



Sección: **16mm²**

300 uds/caja

REF

PVPR

Regleta de conexión para cable eléctrico	16mm²	Blanco	FCH-0016-B	2,04 €
Regleta de conexión para cable eléctrico	16mm²	Negro	FCH-0016-N	2,04 €



Sección: **25mm²**

200 uds/caja

REF

PVPR

Regleta de conexión para cable eléctrico	25mm²	Blanco	FCH-0025-B	3,45 €
Regleta de conexión para cable eléctrico	25mm²	Negro	FCH-0025-N	3,45 €

BRIDAS

ALTA RESISTENCIA



Bridas de **NYLON66** resistentes



NEW!

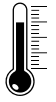

Temperatura de trabajo **-40°C + 85°C**



Mín. temperatura de instalación **20°C**



DESCARGAR
FICHA TÉCNICA



Grado de inflamabilidad del material **UL94V-2**

Ancho bridas

2,5 mm	6,8 mm
3,6 mm	7,6 mm
4,8 mm	

Bridas color **NEGRO** ●



100 UDS en bolsa

Ref		PVPR
BDA-001	BRIDA NEGRA 2.5*150mm NYLON66 IGNIFUGO	1,29€
BDA-003	BRIDA NEGRA 3.6*200mm NYLON66 IGNIFUGO	2,73€
BDA-005	BRIDA NEGRA 3.6*250mm NYLON66 IGNIFUGO	3,42€
BDA-007	BRIDA NEGRA 3.6*300mm NYLON66 IGNIFUGO	3,87€
BDA-009	BRIDA NEGRA 3.6*350mm NYLON66 IGNIFUGO	4,68€
BDA-011	BRIDA NEGRA 3.6*500mm NYLON66 IGNIFUGO	7,56€
BDA-013	BRIDA NEGRA 4.8*200mm NYLON66 IGNIFUGO	3,15€
BDA-015	BRIDA NEGRA 4.8*250mm NYLON66 IGNIFUGO	4,62€
BDA-017	BRIDA NEGRA 4.8*300mm NYLON66 IGNIFUGO	5,28€
BDA-019	BRIDA NEGRA 4.8*350mm NYLON66 IGNIFUGO	6,60€
BDA-021	BRIDA NEGRA 4.8*500mm NYLON66 IGNIFUGO	9,63€
BDA-023	BRIDA NEGRA 6.8*200mm NYLON66 IGNIFUGO	6,84€
BDA-025	BRIDA NEGRA 7.6*500mm NYLON66 IGNIFUGO	18,06€



	W	L
—————	2.5	150 mm
—————	3.6	200 mm
—————	3.6	250 mm
—————	3.6	300 mm
—————	3.6	350 mm
—————	3.6	500 mm
—————	4.8	200 mm
—————	4.8	250 mm
—————	4.8	300 mm
—————	4.8	350 mm
—————	4.8	500 mm
—————	6.8	200 mm
—————	7.6	500 mm

Bridas color **GRIS** ○

Ref		PVPR
BDA-002	BRIDA GRIS 2.5*150mm NYLON66 IGNIFUGO	1,35€
BDA-004	BRIDA GRIS 3.6*200mm NYLON66 IGNIFUGO	2,88€
BDA-006	BRIDA GRIS 3.6*250mm NYLON66 IGNIFUGO	3,60€
BDA-008	BRIDA GRIS 3.6*300mm NYLON66 IGNIFUGO	4,08€
BDA-010	BRIDA GRIS 3.6*350mm NYLON66 IGNIFUGO	4,92€
BDA-012	BRIDA GRIS 3.6*500mm NYLON66 IGNIFUGO	7,95€
BDA-014	BRIDA GRIS 4.8*200mm NYLON66 IGNIFUGO	3,21€
BDA-016	BRIDA GRIS 4.8*250mm NYLON66 IGNIFUGO	4,83€
BDA-018	BRIDA GRIS 4.8*300mm NYLON66 IGNIFUGO	5,55€
BDA-020	BRIDA GRIS 4.8*350mm NYLON66 IGNIFUGO	6,96€
BDA-022	BRIDA GRIS 4.8*500mm NYLON66 IGNIFUGO	10,11€
BDA-024	BRIDA GRIS 6.8*200mm NYLON66 IGNIFUGO	7,20€
BDA-026	BRIDA GRIS 7.6*500mm NYLON66 IGNIFUGO	18,96€

	W	L
—————	2.5	150 mm
—————	3.6	200 mm
—————	3.6	250 mm
—————	3.6	300 mm
—————	3.6	350 mm
—————	3.6	500 mm
—————	4.8	200 mm
—————	4.8	250 mm
—————	4.8	300 mm
—————	4.8	350 mm
—————	4.8	500 mm
—————	6.8	200 mm
—————	7.6	500 mm

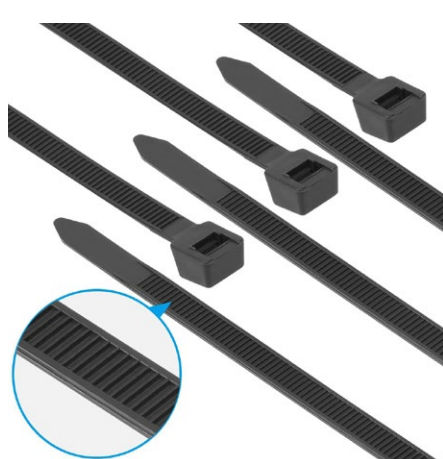

Dientes antideslizantes



Cierre autoblocante más grueso



Diseño antideslizante

Terminación lisa para facilitar la inserción

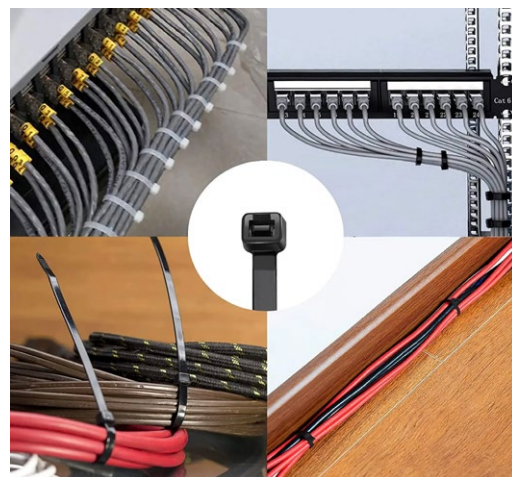

Diferentes modos de uso

NEW!

TACOS A PRESIÓN para fijación de bridas

Los tacos a presión son adecuados para su uso en un amplio rango de materiales como hormigón, ladrillo o madera. Se instalan golpeando sobre el orificio (dependiendo del material). Debido a su amplia cabeza, los manojos de cables pueden colocarse a una distancia del enladrillado mediante el taco.



Temperatura de trabajo
-20°C + 85°C



Mín. temperatura de
instalación 20°C



Grado de inflamabilidad del
material **UL94V-2**



• Buen comportamiento en ambientes húmedos y corrosivos

• Para instalaciones de uso interior o exterior

• Ideal para superficies de

- Hormigón.
- Ladrillo macizo
- Forjado
- Ladrillo hueco

• Facilidad de montaje

• Perfecta retención de la brida.

• Las aletas flexibles ayudan a fijar y sujetar mejor los tubos, sin dañarlos.

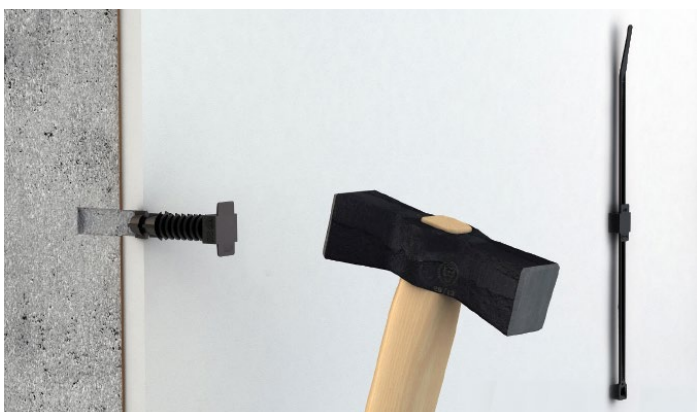

100 UDS en bolsa

Material: Poliamida



TACOS A PRESIÓN PARA FIJACIÓN DE BRIDAS CON ALETA
Negro 8mm

Ref

PVPR

TCDA-001

5,16€



TACOS A PRESIÓN PARA FIJACIÓN DE BRIDAS CON ALETA
Gris 8mm

TCDA-002

5,16€



Domotiza tu vivienda
a la mejor calidad precio

SENCILLO Y EFICAZ

Algunos de nuestros productos son
Compatibles con los principales asistentes de voz
(asistente de Google*, Amazon*, Alexa* ... etc.)**v

Estas marcas son propiedad de sus respectivos propietarios,
y como tal, son reconocidas por Atmos Electric Equipment S.L
y son utilizadas únicamente con fines enunciativos.

App
tuya



HAZ TU VIDA MÁS FÁCIL Y SEGURA

DOMOTIZA TODO TU HOGAR CON PRODUCTOS DE **ATMOSS**

Seguridad



Persianas



Enchufes



Iluminación



Puerta garaje



Domónica

La mejor forma de ampliar la cobertura WiFi en toda la casa

Sistema WiFi Mesh

ACLED-199



Cobertura en toda la casa

Hasta 1371m²



Conexiones WiFi seguras

Cifrado con seguridad inalámbrica **WPA2-PSK** de alto nivel y posibilidad de crear una **red de invitados** independiente de la red doméstica y de la información privada.



REPETIDOR **WiFi MESH**

Ref	PVPR
ACLED-199.....	496,80€



Características:

- Tecnología de conectividad: Inalámbrico
- Clase de banda de frecuencia: Doble banda
- Estándar de comunicación inalámbrica: Radiofrecuencia de 5,8 GHz, 802.11a/b/g/n, Radiofrecuencia de 2,4 GHz
- Protocolo de seguridad: WPA2-PSK
- Ancho de banda del puerto LAN: 1000Mbps
- Tasa máxima de transferencia de datos ascendente: 1000 Megabits por segundo
- Sistema Operativo: IOS, Android
- Método de control: App
- Capacidad eléctrica: M3&Dot 100 - 240 V, 50/60 Hz
- Cobertura en toda la casa: Hasta 1371m²
- Requisitos para la instalación: iOS 9.0 o posterior, dispositivo Android 4.4 o posterior y servicio de Internet
- Características básicas: SSID Broadcast | Beamforming | MU-MIMO
- Funciones avanzadas: Control parental | Red de invitados | Roaming rápido | QoS inteligente, etc.
- Tipo de conexión a Internet: PPPoE | IP dinámica | IP estática | Modo puente

Controles parentales potentes

Administra el tiempo de conexión y bloquea el contenido inapropiado en función de la edad para mantener a la familia protegida.

Puedes crear distintos perfiles de usuario y niveles de filtro para cada miembro del hogar.

Además, podrás crear una red de invitados.

 BLUETOOTH

Kit de sonido ambiental

Altavoces + amplificador



ALT-003 - Amplificador

	Ref	PVPR
KIT DE SONIDO I-MASTER+I-AUXILIAR BLUETOOTH 80h 6,5" 25W	ALT-001	177,75€
KIT DE SONIDO I-AUXILIAR BLUETOOTH 80h 6,5" 25W	ALT-002	45,45€
AMPLIFICADOR ALTAVOZ. (MÁX 8 ALTAVOCES) 80h 4 * 25W	ALT-003	209,40 €

INTERFAZ DE CONTROL:

Alimentación: 230 Vac (Rango Admitido 100-250 Vac) 

Referencia: ALT-001 / 002
Tamaño altavoz: 6.5Inch
MAX Power Output: 120W
Sensibilidad: 88±3db
Impedancia: 8 Ohms
Frecuencia: 50-20KHZ
Diametro corte: 6.5Inch(16.5CM)

Bluetooth® soportado 3.0

Alcance: 8-10 m
Rango frecuencias:
2,40 GHz-2,4832 GHz (Banda ISM)

ALTAVOCES 6,5":

Impedancia: 8 Ω
Potencia: 25 W
Material: ABS
Fijación directa a Falso techo
Dim: Ø Exterior: 190mm
Ø Corte: 165 mm

AMPLIFICADOR ALTAVOCES 80h (MÁX 8 ALTAVOCES)

Potencia: 4*25w
Reproducción mediante:
- Tarjeta micro SD (32GB).
- Bluetooth (≤10m).
- USB (32Gb)

Compatible con formato MP3, WMA, WAV, AAC, WAW, APE, etc.

CABLE DE INSTALACIÓN:

Cable paralelo rojo/negro
Distancia máxima 30m

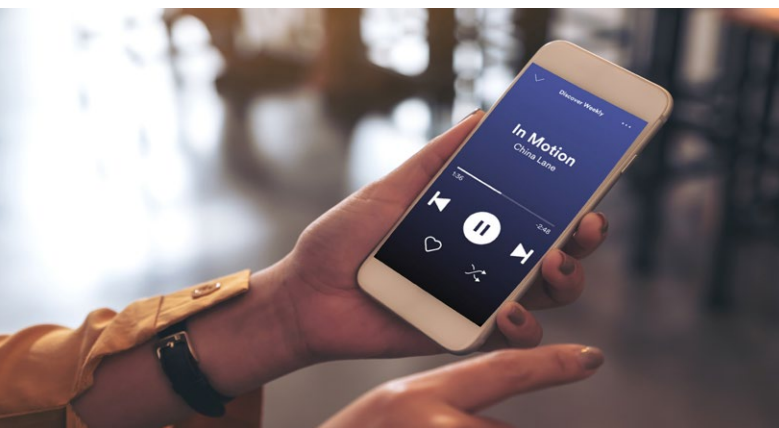



COMPATIBLE CON APP **tuya**

APP CONTROL REMOTO

Administre su iluminación desde cualquier lugar con WiFi



	°K	Ref	PVPR
Miniesférica Led WiFi REGULABLE	4700	BLED-221	21,51€
Miniesférica Led WiFi REGULABLE	4700	BLED-220	21,51€



tuya

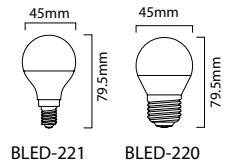

Standar Led WiFi REGULABLE	4700	BLED-219	21,51€
----------------------------	------	----------	--------



tuya

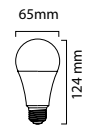

Dicroica Led WiFi REGULABLE	4700	DIC-090	21,51€
-----------------------------	------	---------	--------



tuya

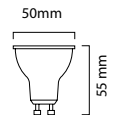

Globo Led WiFi REGULABLE	4700	BLED-222	28,71€
Globo Led WiFi REGULABLE	4700	BLED-223	32,31€



tuya

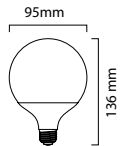

INCLUYE MANDO - REGULABLE - CARRIL TRIFÁSICO

TRACK LIGHT LED INTEGRADO 3CCT	3000	TRCK-056	125,94€
TRACK LIGHT LED INTEGRADO 3CCT	3000	TRCK-057	125,94€



tuya

BLED-222 BLED-223

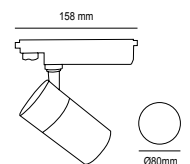



INCLUYE MANDO

Used
OSRAM
LED Chips

* Compatible con TUYA

PROYECTOR DOWNLIGHT RECTANGULAR BLANCO **WIFI - 40w** 3CCT PRY-138 142,56€



tuya

CORTE 230x135

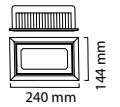

INCLUYE MANDO

* Compatible con TUYA - Mando incluido RF - REGULABLE

PANEL LED 60 X 60CM **WIFI 40W - ARO BLANCO** 3CCT + RGB DOW-318 208,92€



tuya

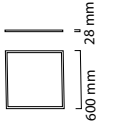

COMPATIBLE CON TUYA - INCLUYE MANDO RF - CON MEMORIA
Para el funcionamiento del mando a distancia es necesario vincular primero el proyector a su conexión wifi.



INCLUYE MANDO

PROYECTOR EXTERIOR WIFI **10W - 750Lm - IP65** RGB 3CCT PRY-104 62,73€



tuya

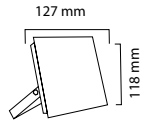

PROYECTOR EXTERIOR WIFI **20W - 1600Lm - IP65** RGB 3CCT PRY-105 66,18€



tuya

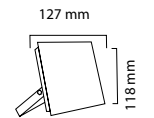

Combina los colores como quieras con el modo RGB.

O cambia de tono entre 3200K hasta 5000K con el modo 3CCT.

Desde un tono cálido, pasando por un blanco hasta un tono frío.

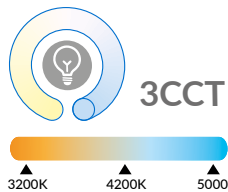

Convierte y controla tu instalación de tiras LED en WiFi

Hasta 5 canales (5 en 1), diferentes colores, con un mismo controlador en un mismo lugar.

Función 5 en 1 solo en CONTR-050/061/062



Controlador tiras led domótica

CONTROLADORES 3CCT Y RGB



COMPATIBLE CON APP **tuya**

Ref PVPR



PARA TIRAS 3CCT y MONOCOLOR

* FUNCIONA CON PULSADOR y APP Tuya

CONTROLADOR TIRA LED 3CCT **WIFI** CONTR-060 75,87€



tuya 

Máx: 10.5A - 5A/CH - 2 canales - 2.4GHz

* COMPATIBLE CON APP TUYA SMART LIFE.



PARA TIRAS 3CCT y MONOCOLOR

* FUNCIONA CON PULSADOR y APP Tuya

CONTROLADOR TIRA LED 2 EN 1 **WIFI - BLUETOOTH** CONTR-097 68,46€



tuya

Máx: 12A - 12A/CH - 2 canales - 2.4GHz

* CONTROL POR VOZ.

* COMPATIBLE CON MiBoxer App y TUYA APP SMART LIFE

* COMPATIBLE CON MANDO **CONTR-028**



Para tiras **RGB** 



PARA TIRAS RGB 24V - **CODIFICADO**

* FUNCIONA CON APP Tuya Y CONTROL REMOTO INCLUIDO

CONTROLADOR TIRA LED RGB **WIFI** CONTR-080 101,40€



tuya

Máx: 15A - 3A/CH - 3 canales - 2.4GHz

* COMPATIBLE CON APP TUYA SMART LIFE.

Para tiras RGB y 3CCT **FUNCIÓN 5 EN 1**



PARA TIRAS 3CCT, RGB+W y 3CCT+RGB - DC12-48V

* **FUNCIONA CON APP Tuya**

CONTROLADOR MiLight TIRA LED 5 EN 1 **WIFI** CONTR-050 78 €



Máx: 15A - 6A/CH - 5 canales - 2.4GHz

* COMPATIBLE CON CONTR-028 (RGB Y 3CCT)
CONTR-030 (MONOCOLOR / DUAL)

* COMPATIBLE CON TUYA APP SMART LIFE y MiBoxer App

* CONTROL POR VOZ.



PARA TIRAS 3CCT, RGB+W y 3CCT+RGB

* **FUNCIONA CON APP Tuya**

CONTROLADOR TIRA LED 5 EN 1 **WIFI** CONTR-061 75,87€



Máx: 15A - 3A/CH - 5 canales - 2.4GHz

* COMPATIBLE CON APP TUYA SMART LIFE.



PARA TIRAS 3CCT, RGB+W y 3CCT+RGB

* **FUNCIONA CON APP Tuya**

CONTROLADOR TIRA LED 5 EN 1 **WIFI - BLUETOOTH** CONTR-062 70,98€



Máx: 15A - 3A/CH - 5 canales - 2.4GHz

* COMPATIBLE CON APP TUYA SMART LIFE.

Pastillas iluminación

Compatible con los principales sistemas de control por voz



Para interruptor simple, conmutado y cruce



Ref PVPR

PASTILLA INTERRUPTOR MINI LED **WIFI 300W LED** CONTR-054 41,91€

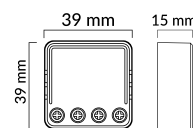

Pastilla **MINI**
39x39x15mm



No apta para instalaciones conmutables

PASTILLA INTERRUPTOR MINI MULTIFUNCIÓN **WIFI 300W LED** CONTR-082 29,85€

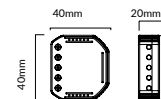

Para DOBLE interruptor e interruptor partido

PASTILLA DOBLE INTERRUPTOR LED **WIFI 2 X 150W** CONTR-042 56,31€

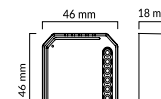

Disponible para varios pulsadores



PASTILLA REGULADOR TRIAC WIFI 300W LED **WIFI 300W LED** CONTR-063 60,66€

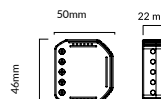

PASTILLA TELERRUPTOR MINI WIFI **16A 230V - 300W LED** CONTR-071 45,06€

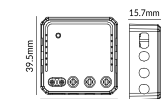



NO DISPONE DE WIFI

PASTILLA REGULACIÓN LED	SIN NEUTRO	MÁX 250W	Ref	PVPR
			CONTR-083	55,02 €

REGULACIÓN TRIAC

Este dimmer LED está diseñado para el control de lámparas LED regulables de hasta 250W. Con características de diseño compacto, brillo ajustable, potencia y memoria de ajuste de luz, es fácil de instalar y operar.

- Tamaño compacto
- Sin ruido
- Regulación del borde de salida
- No necesita línea neutra
- Ideal para reequipamiento
- Luminosidad y velocidad de regulación regulables
- Memoria de potencia y luminosidad

- REGULACIÓN TRIAC
- NO APTA PARA INSTALACIONES CONMUTADAS
- SE PUEDE USAR CON PULSADORES EN PARALELO

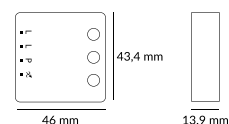

NO DISPONE DE WIFI

PASTILLA PULSADOR CON EFECTO MEMORIA - FUNCIONA PARA VARIOS PULSADORES -

PASTILLA DIMMABLE TRIAC POR PULSADOR	MÁX 360W	Ref	PVPR
		CONTR-022	52,62€



CONTR-036 CONTR-056

COMPATIBLE CON MANDO
CONTR-036 Y CONTR-056

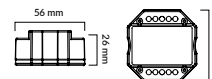

Persiana



Válido para motores de 2 fases, 1 neutro y tierra

PASTILLA INTERRUPTOR DE PERSIANAS	WIFI	Ref	PVPR
		CONTR-045	54,00€



tuya

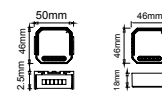

Válido para motores de 2 fases, 1 neutro y tierra

PASTILLA INTERRUPTOR DE PERSIANAS	WIFI + RF433	Ref	PVPR
		CONTR-068	49,80€



tuya

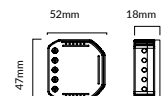

CONTR-069 (1 CANAL)
CONTR-070 (9 CANALES)

MANDO PARA PASTILLA CONTR-068	1 PERSIANA	Ref	PVPR
		CONTR-069	18,84€

MANDO PARA PASTILLA CONTR-068	HASTA 9 PERSIANAS	Ref	PVPR
		CONTR-070	35,70€



Puerta garaje



Incluido finales de carrera

PASTILLA INTERRUPTOR PUERTA GARAJE	WIFI	Ref	PVPR
		CONTR-053	79,08€



tuya

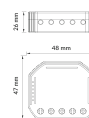

Cerradura electrónica

Solo para cerraduras electrónicas

potencia máx de salida
2300 W



Persianas de garaje, puertas correderas y cerraduras electrónicas

PASTILLA PULSADOR PARA CERRADURAS ELECTRÓNICAS	WIFI	Ref	PVPR
		CONTR-056	41,58€



tuya

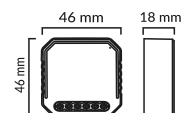

Enchufes

- Compatible con los principales sistemas de control por voz
- Te permite programar múltiples encendidos.
- Control de consumo energético (instantáneo, mensual y anual)

Ref PVPR



ENCHUFE INTELIGENTE SMART CON LUZ **10A WIFI** ACLED-092 43,17€

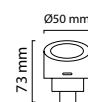

ENCHUFE INTELIGENTE SMART **16A WIFI** ACLED-121 28,56€

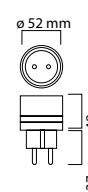

ENCHUFE INTELIGENTE SMART DOBLE BLANCO **2x16A WIFI** ACLED-133 53,85€

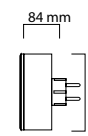

Carga rápida USB

REGLETA INTELIGENTE SMART **10A x 3 tomas + 4usb x 2A WIFI** ACLED-110 72,06€

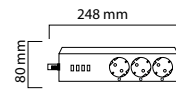

Corte de fase y neutro programable

INTERRUPTOR WIFI PROGRAMABLE **2200W max 10Ah max** CONTR-048 21,51€



Con el interruptor inteligente puedes **apagar y encender cualquier dispositivo**, desde lámparas hasta televisiones, aire acondicionado, estufas, calderas, etc ... Soporta hasta 16A de carga máxima.

El interruptor inteligente se conecta a la WiFi de su domicilio, y con la app Tuya (gratuita para Android e iOS) instalada en tu teléfono móvil puedes controlar desde cualquier sitio si quieres encender o apagar el dispositivo que tengas conectado. Es compatible con redes WiFi.

El interruptor inteligente se conecta a la red eléctrica mediante un bloque terminal de entrada, y tiene otro bloque terminal de salida.

Moderniza tu casa o tu negocio de la forma más fácil y económica.

INTERRUPTOR WIFI PROGRAMABLE **3520W max 16Ah max** CONTR-451 34,92€



Corte de fase y neutro programable



Controla tu hogar desde **1 SOLO PUNTO**



Bajo consumo
Haciendo que las baterías de los productos domóticos duren mucho más.

- Funciona con nuestros módulos WiFi
- Alimentación por batería



CR2430
CR2430 3V
Batería no incluida

1Año
1 Año autonomía

1.3cm
espesor
Fácil de transportar

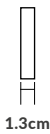

1.3cm



Control remoto



Ajustes escenas
12 escenas



Botón mecánico



Uso interior

	Ref	PVPR
INTERRUPTOR INTELIGENTE 12 ESCENAS	CONTR-093	81,96€



FÁCIL INSTALACIÓN
Montaje en superficie con adhesivo



1 Interruptor
12 ESCENAS 4 AMBIENTES



Aseo



Cocina



Sala de estar



Dormitorio



Cada botón tiene **3 modos de vinculación**
12 escenas



4 botones
pueden ser
individuales



3 métodos
de presión



Elegir dispositivos
inteligentes de
vinculación o control

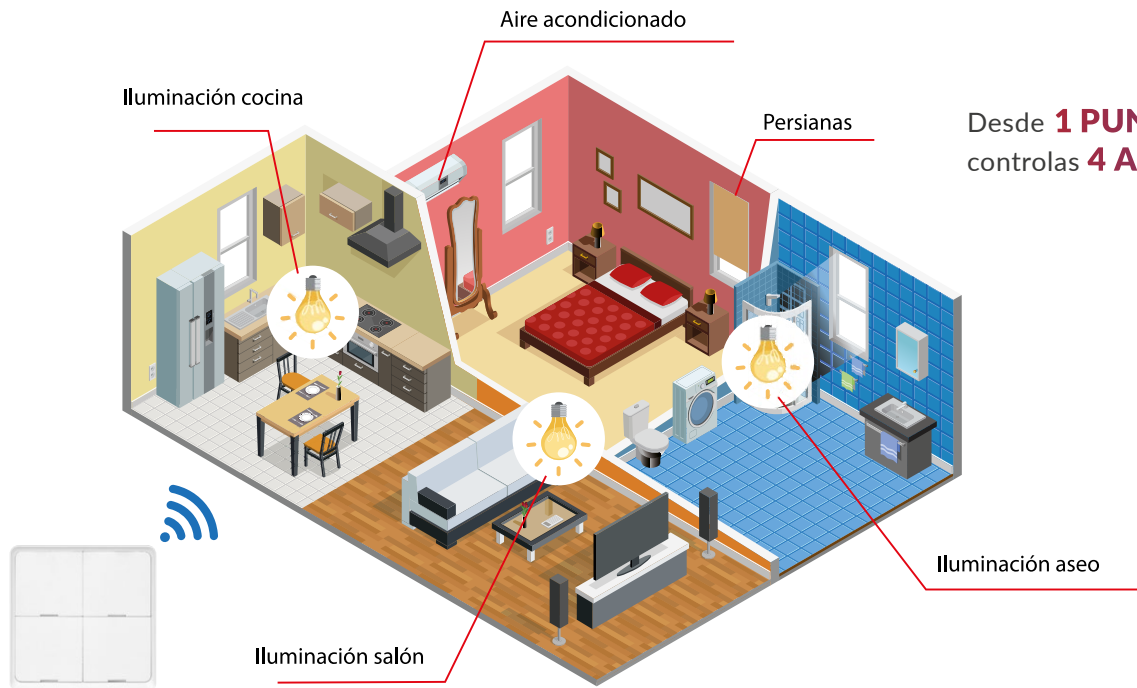

Desde **1 PUNTO**
controlas **4 AMBIENTES**

Puerta de enlace Gateway

Control hasta
128 dispositivos

La puerta de enlace multimodo admite comunicación multiprotocolo Wi-Fi+Bluetooth+Zigbee. La malla Bluetooth (SIG) y la comunicación Zigbee garantizan un control estable de 128 dispositivos.

La puerta de enlace implementa la comunicación entre la nube y los teléfonos móviles a través de Wi-Fi. Los dispositivos Zigbee y Bluetooth mesh (SIG) conectados se pueden ver y controlar de forma remota mediante la aplicación.

Además, los usuarios pueden implementar las funciones de agregar y restablecer dispositivos, control de terceros y control de grupos de subdispositivos. Esas características pueden cumplir con los requisitos de escenarios diversificados de hogares inteligentes



	Ref	PVPR
PUERTA DE ENLACE GATEWAY 	CONTR-094	64,23€

* Todos los datos y precios en catálogo están correctos salvo error tipográfico. **TODOS LOS PRECIOS ESTÁN SUJETOS A MODIFICACIONES.**

Interruptor *inalámbrico*

Añade un interruptor fácilmente donde quieras **SIN NECESIDAD DE CABLEADO**

Kit 2 Interruptores RF Switch + pastilla WiFi



Interruptor RF sin cableado



Sin pilas o batería



Protección del medio ambiente



Ahorro de energía



Fácil instalación



Pastilla con memoria



Se puede añadir varios interruptores

TECNOLOGÍA **KINETIC**



NEW



APP CONTROL REMOTO

COMPATIBLE CON APP **tuya**

2 MODOS DE CONTROL

WIFI + CONTROLADOR RF 433MHZ



• Múltiples interruptores sin acoplarse.



• Controla el encendido apagado a distancia **ON/OFF**

Programa horarios



APLICACIONES



Jardín

La solución minimalista para la iluminación del jardín.

Exterior

Controla la iluminación sin necesidad de moverte.



Sin contacto

Aplicación del interruptor sin contacto para hospitales.

Aseos

Añade interruptor en tu aseo, sin quitar o cambiar azulejos.
Sin necesidad de obras



PASTILLA WIFI y 2 INTERRUPTORES INALÁMBRICOS RF 16A CONTR-081 70,32€

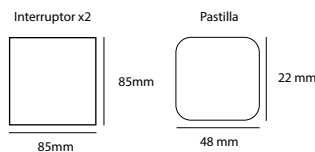

NO NECESITA PILAS O BATERÍA

FÁCIL INSTALACIÓN
Montaje en superficie con adhesivo

- **Simplicidad y comodidad** con un solo clic.
- **Pastilla codificada.** Posibilidad de instalar varias instalaciones sin acoplarse.
- **Compatible** con los principales sistemas de **control por voz.**



CONTROL PROGRAMABLE SEMANAL

APAGADO CON MEMORIA

MODO MÚLTIPLES MODOS DE TRABAJO

VINCULACIÓN RÁPIDA Y SENCILLA

2 pilas AAA - linterna piloto led

Ref PVPR

MANDO UNIVERSAL AIRE ACONDICIONADO PROGRAMABLE 1000 CÓDIGOS CONTR-084 20,70€



1000 EN 1
MAYOR COMPATIBILIDAD

99% Compatible con el 99% de las marcas

Especial para Aire acondicionado y Televisores



CONVERTIDOR WIFI A IR 7-10mts 300mA 2.4Ghz 360° CONTR-047 35,94€

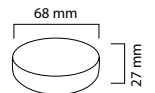

2,4/5,8 GHz - 1200Mbps
3 modos de uso: Repetidor, router, modo AP

REPETIDOR WIFI DOBLE BANDA ACLED-161 130,17€



180°

MEDIDAS: 172x75x52mm
GIRO ANTENAS: 180°



BOTÓN WIFI SOS TUYA SGR-038 47,16€



tuya

Battery
Li-ion LiFePO4
USB TIPO C

Batería
3.7v / 400mAh

EN PARED CON ADHESIVO

COLGADO DEL CUELLO CON LANYARD



5cm

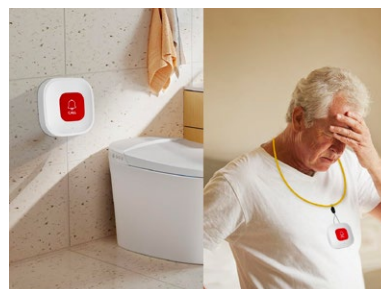

NEW

Control remoto Wi-Fi

Controla a distancia desde tu smartphone cualquier electrodoméstico

COMPATIBLE CON APP **tuya**

Sistema IR



Control remoto WiFi

CONTROL REMOTO WIFI IR + RF

WIFI

Ref

PVPR

CONTR-085

44,85€



Rotación 210°



Control por APP



Control por voz



USB



Link



Escena personalizada

tuya



CONTROL REMOTO WIFI IR + RF con cable USB

WIFI

CONTR-086

46,35€



CONTROL REMOTO WIFI IR + RF cable USB y pantalla TEMP/HUM

WIFI

CONTR-087

39,90€



tuya

CONTR-086

CONTR-087



CONTR-088

Control remoto con SENSOR TEMPERATURA / HUMEDAD

CONTROL REMOTO WIFI IR

WIFI

CONTR-088

55,14€



Sensor de temp



Sensor de humedad



Control por voz

tuya



CONTR-089

CONTROL REMOTO PRO WIFI IR

WIFI

CONTR-089

86,70€



Sensor de temp



Sensor de humedad



Control por voz



Botón táctil



Modo IR

tuya



CONTR-090

Control remoto aire acondicionado

Controla el aire acondicionado de forma remota desde tu smartphone APP

CONTROL REMOTO WIFI Aire Acondicionado Con pantalla

WIFI

CONTR-090

94,35€



CONTROL REMOTO WIFI Aire Acondicionado

WIFI

CONTR-091

59,55€



4 Modos velocidad



5 Modos temperatura



Modo ECO



Historial de temp



Programar horario



Modo comfortable



Aviso cambio filtro de aire

tuya



CONTR-091

Controla la

- Temperatura
- On/Off

- Programa horarios
- Historial de temp

CONTR-090

CONTR-091

NEW

SENSORES domóticos

Protege tu vivienda de la manera más **RÁPIDA** y **FÁCIL DE CONECTAR**.

Envío de notificaciones al smartphone



Compatible con **tuya**

SENSORES PUERTA



ALARMA SEGURIDAD SENSOR PUERTA **CON SONIDO**

WiFi

Ref
SGR-018

PVPR
40,44€



tuya



100dB

Pilas AAA (2*1.5V) No incluidas



ALARMA SEGURIDAD SENSOR PUERTA **SIN SONIDO**

WiFi

Ref
SGR-012

PVPR
31,20€



tuya



Pilas AAA (2*1.5V) No incluidas

Al detectar que se abre la puerta o ventana se dispara la alarma

Programar temporizador para Activar/Desactivar la conexión

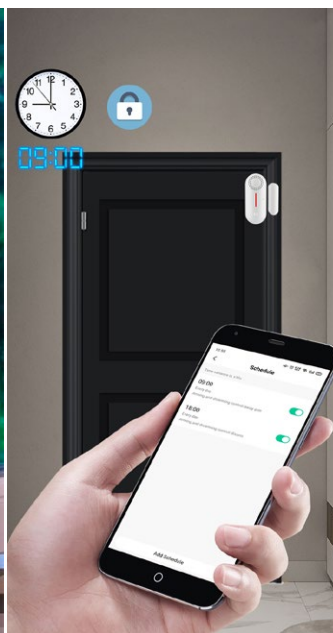

SENSOR AGUA



		Ref	PVPR
ALARMA SEGURIDAD SENSOR FUGAS DE AGUA	WiFi	SGR-013	32,40€



- MONTAJE COLGADO EN PARED
- CON ADHESIVO O TORNILLOS (INCLUIDO)
- AAA PILAS (INCLUIDAS)



tuya

Pilas AAA (2*1.5V) Incluidas



ALARMA SEGURIDAD SENSOR FUGAS DE AGUA	WiFi	SGR-020	30,75€
---------------------------------------	------	---------	--------



- MONTAJE COLGADO EN PARED
- CON ADHESIVOS (INCLUIDO)
- AAA PILAS (NO INCLUIDAS)



tuya

Pilas AAA (2*1.5V) No Incluidas



ALARMA SEGURIDAD SENSOR FUGAS DE AGUA SUELO	WiFi	SGR-019	42,60€
---	------	---------	--------



- MONTAJE EN EL SUELO



tuya

Pilas DC3V CR123A (Incluida)



- Cierra la válvula de agua de forma remota

CIERRE VALVULA WIFI	WiFi	SGR-023	71,10€
---------------------	------	---------	--------



- Tiempo de cierre y apertura de la válvula 5-10 seg
- Válvula de palanca



tuya

Alimentación mediante transformador 230V/12V (Incluido)

Detecta y envía notificaciones de posibles fugas de agua y cierra la válvula de agua de forma remota.

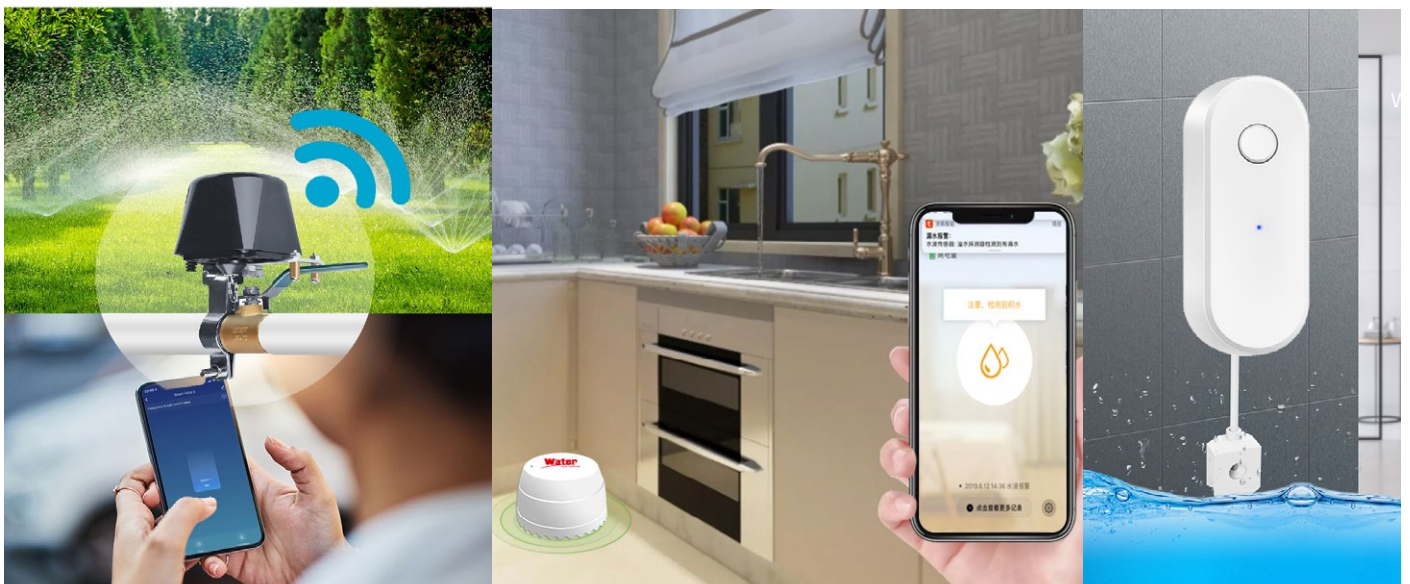

SENSOR PIR ((人))



ALARMA SEGURIDAD SENSOR PIR

WiFi

Ref

SGR-014

PVPR

41,70€



tuya

Alimentación USB DC5V (Incluida)

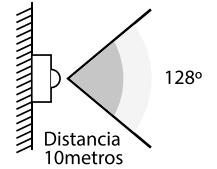

ALARMA SEGURIDAD SENSOR PIR **CON SONIDO ALARMA**

WiFi

Ref

SGR-025

PVPR

56,25€



tuya

100dB

Alimentación USB DC5V (Incluida)

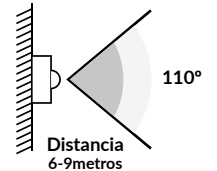

SENSOR DE MOVIMIENTO INTERIOR PORTATIL 3V

WiFi

Ref

SGR-026

PVPR

68,10€



tuya

LED AZUL SEÑAL DE ALARMA

Pila 1 ud - CR17335/CR123A DC5V (Incluida)

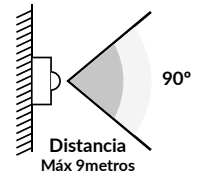

Detección de movimiento SOLAR

Larga duración

Battery Li-Ion LiFePO4
3,7V 600mAh

Posibilidad de cargar con USB



SENSOR DE MOVIMIENTO SOLAR **CON SONIDO ALARMA**

WiFi

Ref

SGR-022

PVPR

97,35€



CARGA SOLAR O USB

tuya

SOLAR

120dB

Duración alarma 20seg

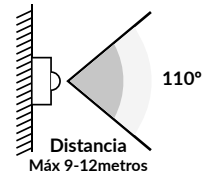

Control remoto por mando a distancia

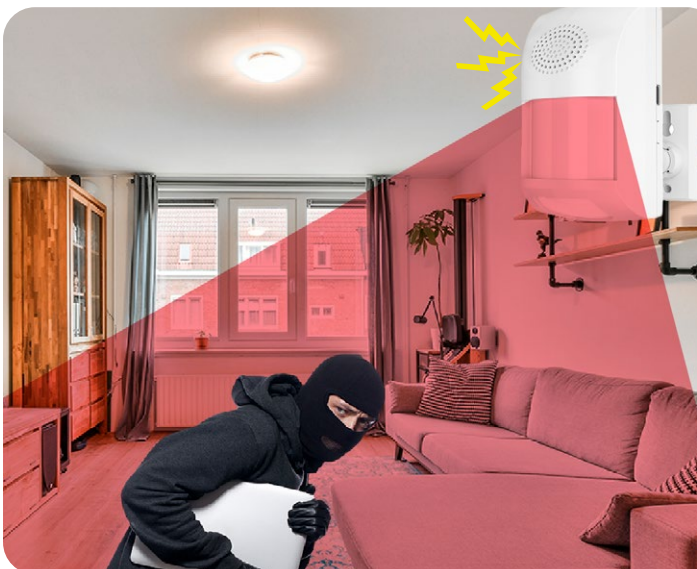

SENSOR DE EXTERIOR 

- ALARMA 120dB
- BATERÍA GRAN AUTONOMÍA
- CARGA SOLAR
- ROTACIÓN 360°
- DETECCIÓN 12 Metros 120° Ángulo



CON SONIDO ALARMA

ALARMA SEGURIDAD SENSOR GAS NATURAL / METANO / BIOGAS

Ref PVPR
WiFi SGR-021 65,58€



- DETECCIÓN DE GAS NATURAL / METANO / BIOGAS

80dB



tuya

Alimentación USB DC5V (Incluida)



COLOCACIÓN ALARMA SEGURIDAD SENSOR GAS NATURAL / METANO / BIOGAS

Estos gases tienden a elevarse. La posición correcta es cerca del techo o en puntos altos. Aproximadamente a 30cm del techo.

Para más información consultar ficha técnica

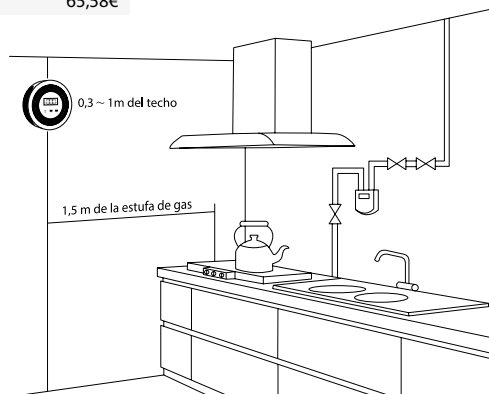

CON SONIDO ALARMA

DETECTOR DE HUMO

WiFi SGR-028 89,25€



85dB



tuya

Pila DC3V CR123A / CR17335 (Incluida)



COLOCACIÓN DETECTOR DE HUMO

Debe ubicarse entre las áreas para dormir y las posibles fuentes de incendio, como salas de estar y cocinas. Debe colocarse en el centro del techo en una habitación

Para más información consultar ficha técnica

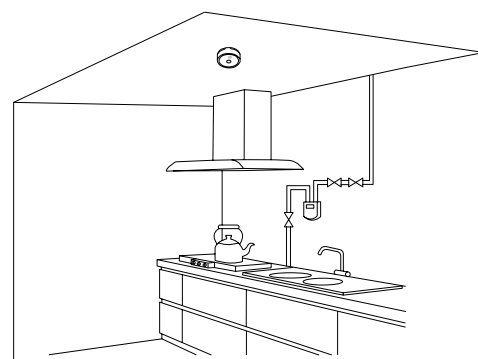

CON SONIDO ALARMA

DETECTOR DE MONÓXIDO DE CARBONO

WiFi SGR-027 89,25€



85dB



tuya

Pilas DC3V AAA 2*1.5V (Incluidas)



COLOCACIÓN DETECTOR DE MONÓXIDO DE CARBONO

Debe instalarse al nivel de los ojos, es decir a una altura de entre 1,5 y 1,7 metros y como máximo a 1 metro de la fuente de emisión.

Para más información consultar ficha técnica

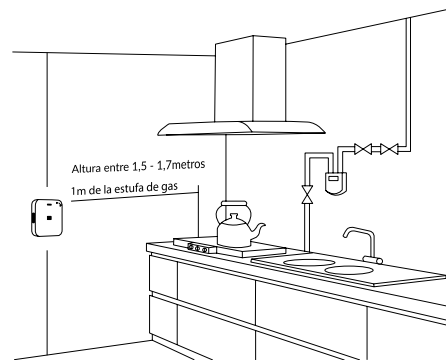

Seguridad

ALARMA

KIT DE ALARMA SEGURIDAD

Compatible con los principales sistemas de control por voz

ADMITE HASTA 25 ACCESORIOS ENLAZADOS

Accesorios compatibles con nuestro Kit de Alarma Atmoss con SGR-001



Contenido de la caja:

- 1u alarma
- 1u mando auxiliar
- 1u sensores movimiento
- 1u cargador USB
- 3u sensores puertas/ventana

Ref SGR-001
PVPR 144,27€

Sensor movimiento	Sensor puerta/ventana	Sensor agua	Timbre inalámbrico	Mando auxiliar
Ref SGR-002	Ref SGR-003	Ref SGR-004	Ref SGR-005	Ref SGR-006
PVPR 18,75€	PVPR 12,96€	PVPR 28,22€	PVPR 11,22€	PVPR 9,45€

ALARMA WIFI / GSM / APP

DESCARGAR **MANUAL INSTALACIÓN**



Kit Sistema de seguridad GSM

- Compatible con los principales sistemas de control por voz.
- Tecnología GSM:

tuya

Conecta la alarma con el número telefónico programado previamente por el propietario, para informar de lo sucedido en el hogar por medio de un mensaje (SMS). La alarma de seguridad no dejará de sonar hasta que el usuario no de respuestas al sistema, indicando que todo se encuentra bien.

KIT SEGURIDAD PANEL + SENSOR MOVIMIENTO + MANDO. CON TARJETA SIM - Ref SGR-024 PVPR 243,45€

Incluye

Detector de movimiento PIR	Sensor puerta / ventana	Mando inalámbrico	Llave RFID	Sirena
Ref SGR-037	Ref SGR-036	Ref SGR-035		
PVPR 20,04€	PVPR 10,08€	PVPR 12,36€		

Sistema de alarma

- Acabado moderno
- Resistente al agua y polvo
- Teclado táctil
- WiFi
- Tecnología GSM (Admite tarjeta SIM)



Accesorio

Añade al sistema de alarma



SENSOR DE MOVIMIENTO SOLAR EXTERIOR PARA SGR-024

Ref SGR-040 PVPR 74,10€



WiFi



GSM (Tarjeta SIM)



Teclado táctil



SMS / Llamada alerta



Llave RFID

SOS

SOS



App mensaje push



Diferentes idiomas

AUTOMATIZA TODA TU CASA DESDE EL PANEL TÁCTIL DE CONTROL



Un toque especial para tu HOGAR INTELIGENTE Controla MÁS DE 100 DISPOSITIVOS desde el mismo panel

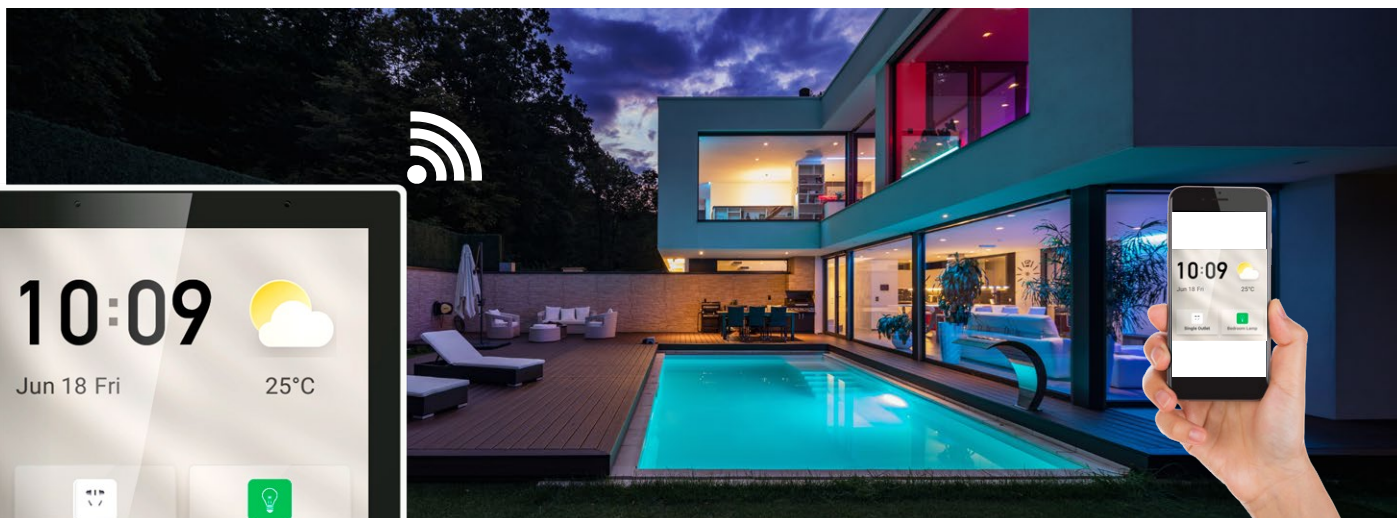

• Crea diferentes escenas de casa.

PANEL TÁCTIL DE CONTROL PARA EL HOGAR WIFI Ref PVPR
CONTR-092 564,30€

DESCARGAR **MANUAL INSTALACIÓN**

- CPU --- PX30 Quad Core Cortex-A35
- OS --- Android 8.1
- RAM --- 1GB
- ROM --- 8GB
- PANTALLA --- 4pulgadas 480*480 táctil
- BLUETOOTH --- BLE 4.2 Single point
- ETHERNET --- N/A
- WiFi --- 802.11b/g/n150Mbps 2.4GHz
- Zigbee --- 802.15.4 PHY/MAC Zigbee network protocol stack
- Voz --- No admite activación por voz.

CERRADURA INTELIGENTE

Libertad y seguridad
Bloquea/Desbloquea tu
puerta a distancia

Envío de notificaciones
al smartphone



Compatible con **tuya**

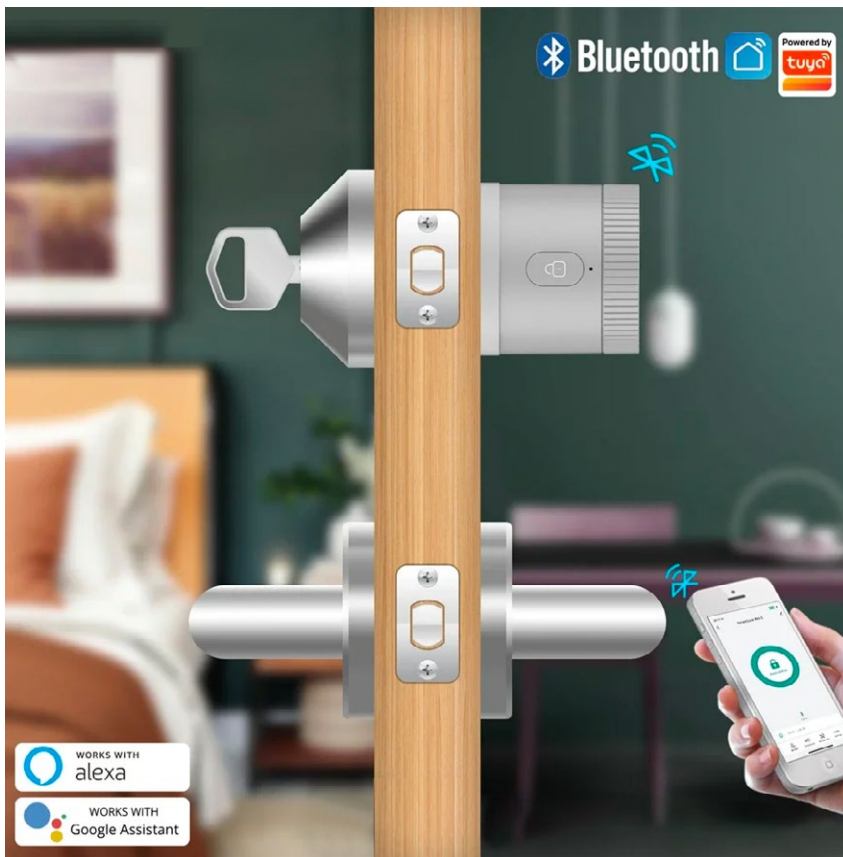



Desbloqueo/Bloqueo temporal con Hora

Añada la cuenta de Tuya para el desbloqueo temporal por otros como uso compartido del dispositivo.

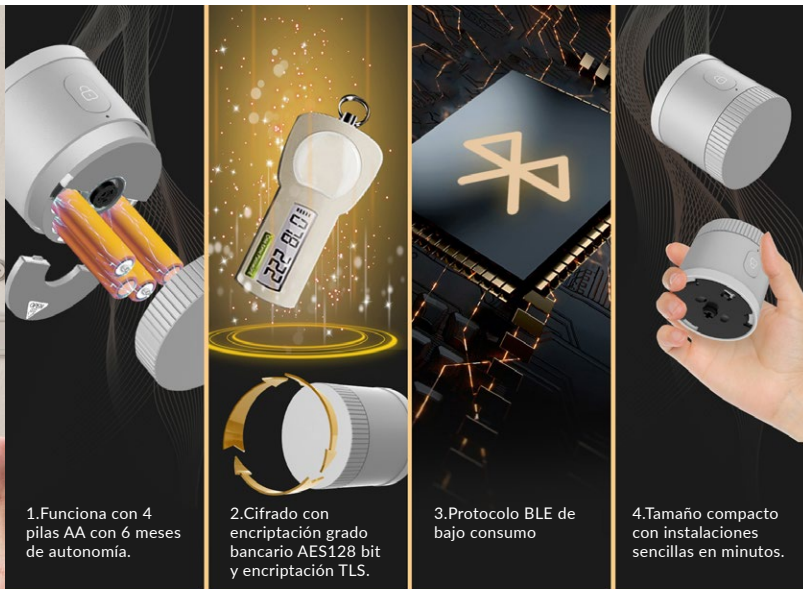

1. Funciona con 4 pilas AA con 6 meses de autonomía.

2. Cifrado con encriptación grado bancario AES128 bit y encriptación TLS.

3. Protocolo BLE de bajo consumo

4. Tamaño compacto con instalaciones sencillas en minutos.

Nota: Las pilas no están incluidas en el paquete, por favor, cómprelas por separado.

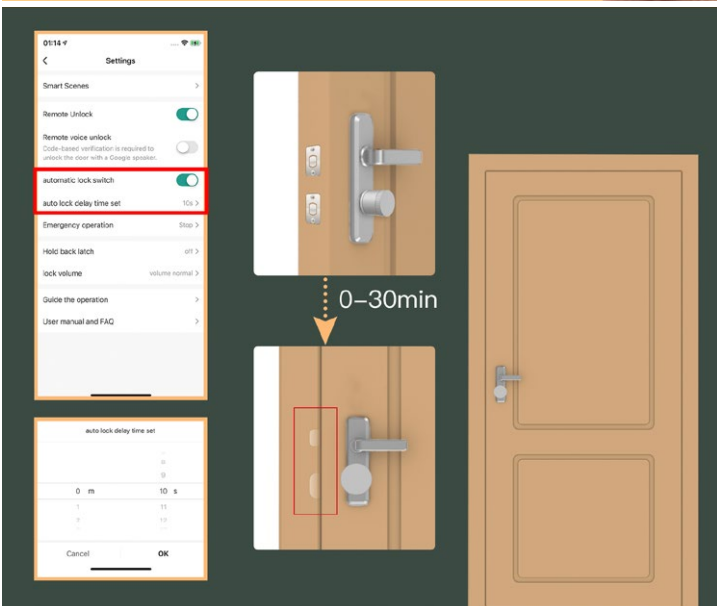

Instalación sencilla en 10 minutos sin perforar

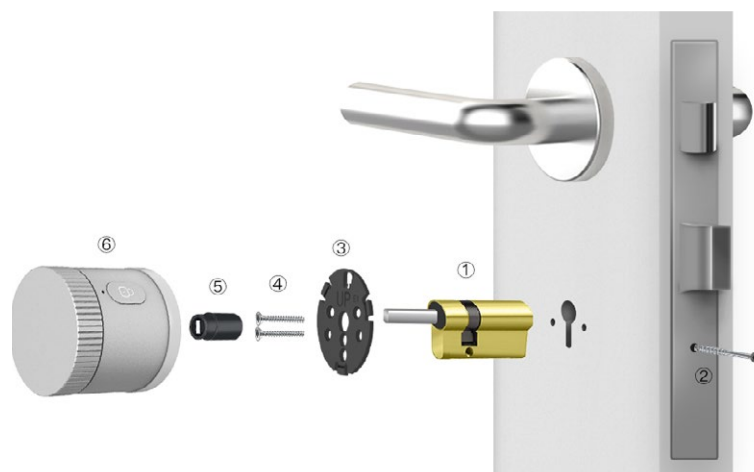

Ajuste el tiempo de retraso para el bloqueo automático
Bloquear automáticamente la puerta cuando se desbloquea dentro del tiempo establecido.



CERRADURA INTELIGENTE



Ref
SGR-039

PVPR
446,85€



Puerta de enlace Gateway no incluido - Pilas no incluidas



Necesario incluir

Puerta de enlace Gateway



PUERTA DE ENLACE GATEWAY



Ref
CONTR-094

PVPR
64,23€



* Todos los datos y precios en catálogo están correctos salvo error tipográfico. TODOS LOS PRECIOS ESTÁN SUJETOS A MODIFICACIONES.

CONTROLA LA TEMPERATURA A DISTANCIA DESDE TU SMARTPHONE O LA VOZ

Termostato WiFi inteligente **tuya**, controlador de temperatura para caldera de gas y termo eléctrico.



COMPATIBLE CON APP **tuya**

"Compatible con los principales asistentes de voz (asistente de Google*, Amazon*, Alexa* ... etc.)"

COMPATIBLE CON SISTEMA DE VOZ **Alexa**

Estas marcas son propiedad de sus respectivos propietarios, y como tal, son reconocidas por Atmos Electric Equipment S.L. y son utilizadas únicamente con fines enunciativos.

TERMOSTATO CALDERA WIFI-TUYA
CON ACCESORIO REMOTO

TERM-001 - 245,52€



Funciona con Google Home.
SUPERFICIE



Ficha técnica



Video vinculación

EL WIFI SOLO FUNCIONA CUANDO ESTÁ CONECTADO POR USB O a 230V

CONTROL PRECISO DE LA TEMPERATURA



EMPOTRADO DE PARED

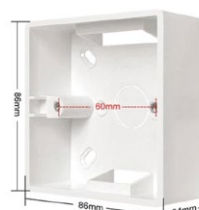

CAJA PARA TERMOSTATO
TERM-002 3,72€

TERM-003

TERMOSTATO CALDERA WIFI-TUYA

TERM-002 - 115,20 €



Ficha técnica



- Termostato caldera WiFi inteligente tuya, controlador de temperatura para caldera de gas y termo eléctrico.



"Compatible con los principales asistentes de voz (asistente de Google*, Amazon*, Alexa* ... etc.)"

Estas marcas son propiedad de sus respectivos propietarios, y como tal, son reconocidas por Atmos Electric Equipment S.L y son utilizadas únicamente con fines enunciativos.

TERMOSTATO CALDERA WIFI-TUYA

TERM-006 - 119,16€



Características:

Instrucciones

- | | |
|-----------------------------------|------------------------------------|
| 1. Fuente de alimentación: | 100 ~ 240V |
| 2. Carga actual: | ≤3A (caldera) |
| 3. Consumo de energía: | <1w |
| 4. Material externo: | PC + ABS (retardante de llama) |
| 5. Elemento sensor: | CNT |
| 6. Establecer temperatura. Rango: | 5-95°C |
| 7. Temp. establecida del piso: | 5-60°C |
| 8. Precisión del rango: | ±1°C |
| 9. Dimensión: | 86 x 90 x 14mm |
| 10. Temp ambiente: | 0-45°C, 5-95%RH (sin condensación) |
| 11. Temp de almacenamiento: | - 5 ~ 55°C |
| 12. Error de sincronización: | <1% |

- Termostato WiFi inteligente tuya, controlador de temperatura para suelo radiante.



"Compatible con los principales asistentes de voz (asistente de Google*, Amazon*, Alexa* ... etc.)"

Estas marcas son propiedad de sus respectivos propietarios, y como tal, son reconocidas por Atmos Electric Equipment S.L y son utilizadas únicamente con fines enunciativos.

TERMOSTATO SUELO RADIANTE WIFI-TUYA

TERM-004 - 107,25€



Características:

Instrucciones

1. Sensor de temperatura: NTC
2. Precisión de temperatura: ± 1°C
3. Pantalla de visualización. LCD
4. Ambiente de trabajo: -5-50°C
5. Potencia de autoconsumo: <1w
6. Ajuste de temperatura: 5-60°C
7. Rango de visualización: 0-51°C
8. Corriente de carga: calentador eléctrico 16A (resistiva)
9. Tensión: AC100-240V, 50/60Hz

- Válvula regulable WiFi inteligente tuya, controlador de temperatura para radiadores.



"Compatible con los principales asistentes de voz (asistente de Google*, Amazon*, Alexa* ... etc.)"

Estas marcas son propiedad de sus respectivos propietarios, y como tal, son reconocidas por Atmos Electric Equipment S.L y son utilizadas únicamente con fines enunciativos.

VÁLVULA REGULABLE PARA RADIADORES WIFI-TUYA

TERM-005 - 198€



Características:

Instrucciones

- Alimentación: 3 x 1.5V alcalina AA Batería (no incluida)
- Corriente: 64A
- Protección: IP20
- Temperatura: 0-50°C
- Temperatura de la superficie: 90°C Máx
- Conexión: M30 x 1.5mm
- Recorrido lineal: 6mm
- Dimensiones: 59.4 x 99.3 x 59.4 mm
- Peso: 145gr

* Todos los datos y precios en catálogo están correctos salvo error tipográfico. **TODOS LOS PRECIOS ESTÁN SUJETOS A MODIFICACIONES.**

COMPATIBLE
CON APP

tuya

CONEXIÓN USB



SOLO ES COMPATIBLE CON LA RED 2,4G - NO CONECTAR A UNA RED 5G O DUAL POR BLOQUEO DE CÁMARA



1080P - BLANCA - VISIÓN NOCTURNA EN COLOR - Motorizada

CAMARA WIFI VIGILANCIA 2-PRO PTZ INTERIOR

IP40

CAM-004

83,16€



5V - 2A



Ficha técnica



Video vinculación con TUYA

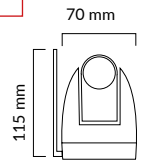

BLANCA - VISIÓN NOCTURNA EN COLOR -
ROTACIÓN PANORÁMICA

"Compatible con los principales asistentes de voz
(asistente de Google*, Alexa*)"

2K
QUADHD

CAMARA DOMO WIFI VIGILANCIA 3-PRO PTZ INTERIOR

2K 3.0MP

CAM-005

125,94€



MOTORIZADO

MANUAL

Ficha técnica

Video vinculación con
TUYA

5V - 1A

tuya

CONEXIÓN USB

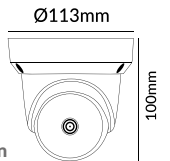

La nueva cámara **DOMO CAM-005** cuenta con un diseño en forma de cúpula ideal para protección de espacios interiores. Ideal para pasar inadvertido, colocación en el techo con una rotación y visión panorámica.

2K
QUADHD

ALTA RESOLUCIÓN 2K

CÁMARA DOMO WIFI VIGILANCIA 3-PRO PTZ INTERIOR

- WIFI
- COMPATIBLE CON TUYA
- SEGUIMIENTO DE OBJETOS
- 1080P
- PTZ
- VISIÓN NOCTURNA EN COLOR
- ROTACIÓN PANORÁMICA
- COMPATIBLE CON LOS PRINCIPALES ASISTENTES DE VOZ

INCLINACIÓN
VERTICAL
MECÁNICA

120°

MOVIMIENTO
MOTORIZADO

360°

COMPATIBLE
CON APP

tuya

NEW!

CASQUILLO E-27 INCLUIDO

CONEXIÓN E27

**NUEVA CÁMARA!!!
CON ROSCA E-27**

PTZ

**2.0 MP
MEGAPIXEL**

COMPATIBLE CON APP tuya

IDEAL PARA DIFERENTES ESCENARIOS



	Ref	PVPR
CÁMARA WIFI VIGILANCIA MINI-E27 PTZ INDOOR	CAM-008	80,40€



Ficha técnica

- TRANQUILIDAD ASEGURADA -

Mantén **SEGURO** tu hogar con la cámara "Black-Eye"

- MULTIPLES INSTALACIONES -

Techo - Sobremesa - Pared

NEW!

PTZ

Notificaciones emergentes de señal de alarma.

Seguimiento de movimiento.

**2.0 MP
MEGAPIXEL**

COMPATIBLE CON APP tuya

SISTEMA DOMO

	Ref	PVPR
CÁMARA WIFI VIGILANCIA BLACK-EYE INDOOR PTZ	CAM-007	83,16€



5V - 1A **CONEXIÓN USB**



* Todos los datos y precios en catálogo están correctos salvo error tipográfico. **TODOS LOS PRECIOS ESTÁN SUJETOS A MODIFICACIONES.**

NEW!

CÁMARA DE SEGURIDAD WIFI

Soporte retráctil y giratorio



DETECCIÓN DE MOVIMIENTO

Envía notificaciones al smartphone cuando detecta movimiento.

2.0MP
MEGAPIXEL

COMPATIBLE
CON APP **tuya**



WIFI



2 canales
audio



Sin
instalación



Sensor de
movimiento



PTZ



Resolucion
HD



Admite
tarjeta SD



Visión nocturna
a color



CÁMARA WIFI MINI CUBO **VIGILANCIA INTERIOR**

Ref

PVPR

CAM-012

56,85€



CONEXIÓN USB



CAMARAS DE EXTERIOR

COMPATIBLE CON APP **tuya**



1080P - BLANCA - Fija

CÁMARA WIFI VIGILANCIA FULL HD VISIÓN NOCTURNA EXTERIOR IP65

Ref CAM-002 PVPR 108,15€

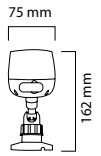

Ficha técnica

Video vinculación con TUYA



NUEVA CÁMARA
CÁMARA EXTERIOR SOLAR ☀️

Conecta tu cámara sin necesidad de cableado, ni toma eléctrica



COMPATIBLE CON APP **tuya**

Battery Li-ion LiFePO4 Bateria 4uds 18650 5W



La CAM-010 Cámara 4G Solar es perfecta para sitios que no hay energía eléctrica o sin Wifi. Como granjas, sitios de construcción, casas de vacaciones, almacenes, etc.

* Acepta Tarjeta SIM, (NO INCLUIDA)

		Ref	PVPR
CÁMARA SOLAR 4G	3MP PTZ EXTERIOR IP66	CAM-010	322,38€
CÁMARA SOLAR WIFI	3MP PTZ EXTERIOR IP66	CAM-011	265,68€



CÁMARA EXTERIOR WIFI VIGILANCIA PTZ CON ALARMA

CAM-006

2.0MP
MEGAPIXEL

SISTEMA
WIFI

IP66

COMPATIBLE
CON APP **tuya**

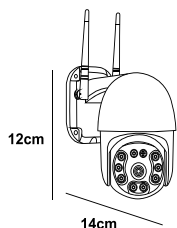
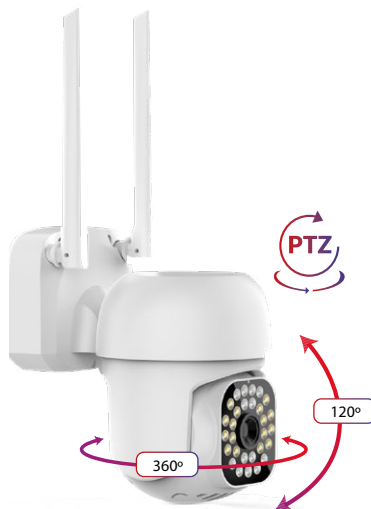

1080P - BLANCA - VISIÓN NOCTURNA EN COLOR - MOTORIZADA

Ref **PVPR**

CAMARA WIFI VIGILANCIA PTZ SIRENA **2,4 / 5G IP66** CAM-006 122,76€



CONEXIÓN USB



Ficha técnica

CAMARAS CON VIDEOGRABADOR IP65



CONEXIÓN POR CABLE - Compatible con los principales sistemas de control por voz - Fijas
VIDEOGRABADOR CON MARCAS DE AGUA

Ref **PVPR**

KIT CAMARAS SEGURIDAD TUYA **CABLE RED 4CH 1080P POE 1TB HDD** SGR-007 718,62€



tuya



Contenido de la caja:

- 1 Grabador NVR con HDD
- 4 Cable red 2x18,5m-2x30,5m
- 1 Ratón USB
- 1 Adaptador 52V 2A Grabador
- 4 Cámaras IP
- 1 Manual de usuario
- 4 Llave Allen para cámaras
- 4 Bolsa tornillos (para cámaras)



CÁMARAS EXTERIOR IP 65

SISTEMA POE
Conexión por cable

Cuerpo de Aluminio



CÁMARA TIPO BULLET

Ideal para vigilancia de aire libre y zonas de amplio rango de visión.

Debido a su diseño alargado le permite cubrir una amplia zona de visión.

- Detección de cuerpo humano
- Enfoque automático
- Grabación automática
- Aluminio
- Notificación por detección de movimiento
- Conexión por cable
- Videograbador con marcas de agua
- Compatible con los sistemas de control de voz
- Cámaras fijas

Sistema profesional de vigilancia

Visión por APP tuya Smartphone o ordenador



CONEXIÓN POR CABLE - Compatible con los principales sistemas de control por voz - Fijas - VIDEOGRABADOR CON MARCAS DE AGUA



NEW!

SISTEMA POE

2K QUADHD

5.0MP MEGAPIXEL

1TB HDD

4CH

KIT CAMARAS SEGURIDAD	Ref	PVPR
WIFI TUYA 4CH 2K 1TB + HDD	SGR-029	836,55€

230V 1 POE IP 65 tuya



NEW!

SISTEMA POE

2K QUADHD

5.0MP MEGAPIXEL

2TB HDD

8CH

KIT CAMARAS SEGURIDAD	Ref	PVPR
WIFI TUYA 8CH 2K 2TB + HDD	SGR-030	1553,58€

230V 1 POE IP 65 tuya



CÁMARAS EXTERIOR

IP 65



SISTEMA POE
Conexión por cable

- Detección de cuerpo humano
- Enfoque automático
- Grabación automática
- Aluminio
- Notificación por detección de movimiento
- Conexión por cable
- Videograbador con marcas de agua
- Compatible con los sistemas de control de voz
- Cámaras con movimiento PTZ 355° y 90°
- Bidireccional



Sistema profesional de vigilancia

Visión por APP **tuya** Smartphone o ordenador



CONEXIÓN POR CABLE - Compatible con los principales sistemas de control por voz -
PTZ - VIDEOGRABADOR CON MARCAS DE AGUA



KIT CAMARAS SEGURIDAD	Ref	PVPR
WIFI TUYA 4CH 2K 1TB + HDD	SGR-032	855,42€



KIT CAMARAS SEGURIDAD	Ref	PVPR
WIFI TUYA 8CH 2K 2TB + HDD	SGR-033	1440,36€



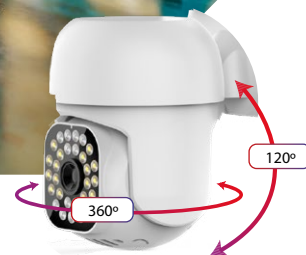

CÁMARAS EXTERIOR IP 65



VISIÓN NOCTURNA A COLOR



SISTEMA WIFI



SE ENCIENDE EL FLASH AL DETECTAR MOVIMIENTO



SEÑAL WIFI NO AMPLIFICABLE

- Hasta 450 m de distancia de transmisión sin barreras.
- 30 m a través de paredes.

* (Sujeto a variaciones según condiciones de instalación)

Sistema profesional de vigilancia

Visión por APP **tuya** Smartphone o ordenador



CONEXIÓN WIFI - Compatible con los principales sistemas de control por voz - PTZ - VIDEOGRABADOR CON MARCAS DE AGUA



NEW!

KIT CAMARAS SEGURIDAD	Ref	PVPR
WIFI TUYA 8CH 2K 2TB + HDD	SGR-031	874,29€

SISTEMA WIFI
 2K QUADHD
 1TB HDD
 2K
 4CH
 PTZ
 3.0MP MEGAPIXEL

230 v
 1
 WIFI
 IP 65
 tuya

Timbres

NEW!



Posición
horizontal

TIMBRE DING DONG 230V *Blanco* TIMB-001 7,56€



85dB

Sonido
Ding-Dong



Posición **DISEÑO**
vertical **MODERNO**

TIMBRE DING DONG 230V *Blanco* Ref PVPR
TIMB-002 8,94€



90dB

Sonido
Ding-Dong



Posición
vertical

TIMBRE DING-DONG *Blanco* TIMB-395 8,94€



80dB

Sonido
Ding-dong



Volumen **38**
REGULABLE 30-80dB **sonidos**

TIMBRE DING-DONG *Blanco* TIMB-393 18,54€



30-80dB

38Sonidos



TIMBRE DING-DONG *Blanco* TIMB-394 13,92€



80dB

Sonido
Ding-dong



NEW! TIMBRE EXTERIOR INALÁMBRICO WIFI
CÁMARA BOTÓN Y ACCESORIO TIMBRE

- COMPATIBLE CON LA APP PROPIA
- NO COMPATIBLE CON TUYA

USO
EXTERIOR/
INTERIOR

TIMB-398

50,52 €



VISIÓN NOCTURNA ALTA DEFINICIÓN

Función de visión nocturna por infrarrojos.
Conmutación automática día/noche



38 melodías para elegir

Melodías incorporadas, volumen ajustable

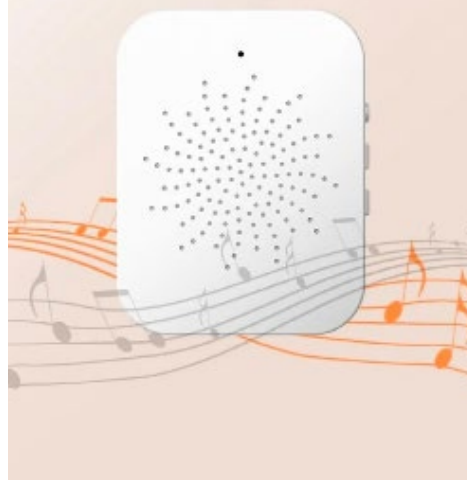

Fácil instalación

Con adhesivo o tornillo

Pegamento adhesivo 3M
Fijación física con tornillos



Pegamento adhesivo 3M



Fijación física con tornillos



-  36 Tonos
-  100-120 metros (distancia abierta)
-  Señal LED

TIMBRE DING DONG 230V INALÁMBRICO CON BOTÓN

Ref	PVPR
TIMB-003	22,56€

-  1
-  230 V
-  Bateria 12V 23A
-  Bajo Medio Alto
-  38 Tonos
-  Rango de distancia 80mts



TIMBRE INALÁMBRICO KINETIC - SIN BATERÍA
TIMB-396

DIFERENTES COMBINACIONES ENTRE TIMBRES KINETIC

-  38 Sonidos
-  4 Niveles volumen
-  Protección impermeable IP44
-  230v Receptor
-  Distancia larga (Hasta 150mts)
-  Señal fuerte

TIMBRE EXTERIOR INALÁMBRICO KINETIC BOTÓN Y ACCESORIO TIMBRE

TIMB-396 33,24€  **SISTEMA RF - NO FUNCIONA POR WIFI**



USB TIMBRE INALÁMBRICO
TIMB-397

-  38 Tonos
-  3 Niveles volumen
-  USB interface receptor enchufe
-  Amplio rango de trabajo
-  Fuerte penetración

TIMBRE EXTERIOR INALÁMBRICO CON BATERIA BOTÓN Y ACCESORIO TIMBRE

TIMB-397 17,46 €  **SISTEMA RF - NO FUNCIONA POR WIFI**

Diferentes combinaciones

Puedes añadir uno o más receptores al pulsador.
O viceversa. Añadir varios pulsadores con el mismo receptor.



TIMBRE CON SENSOR DE MOVIMIENTO POR INFRARROJOS
RECEPTOR + SENSOR

Ref	PVPR	↓
SGR-015	40,44€	

CONEXIÓN

- EL SENSOR UTILIZA 3 PILAS AAA
- EL EMISOR SE CONECTA A 230V AL ENCHUFE



ALTAVOZ DEL TIMBRE
PARA SENSOR SGR-016

Ref	PVPR
SGR-017	24,36€



SENSOR DE MOVIMIENTO
PARA TIMBRE SGR-017

Ref	PVPR
SGR-016	16,08€

SE PUEDE VENDER POR SEPARADO

- RANGO DE TRABAJO DE 100 METROS ENTRE RECEPTOR Y EMISOR

Ideal para puertas de entrada, marcos de ventanas, entradas de vehículos, caminos peatonales y cualquier lugar de su casa en el que desee recibir una alerta de movimiento. También es ideal para alertar a los propietarios de negocios que están trabajando en la parte trasera, o fuera de la vista, a los clientes que entran en su tienda.

**SERIE COMBINABLE
HASTA 32 ELEMENTOS**
POSIBILIDAD DE AÑADIR
VARIOS TIMBRES Y SENSORES



IDEAL PARA PUERTAS, TIENDAS,...



Rotación



100m
Distancia



IP65
Impermeable



38
Melodías



NEW!



TIMBRE CON CÁMARA WIFI TUYA CON BATERÍA

TIMBRE CON CÁMARA WIFI TUYA CON BATERÍA

Ref

PVPR

SGR-010

239,85€



1080P
HD Video



Dos canales
audio



Visión
nocturna



166° Ángulo lente



Sensor de
movimiento
PIR



Gran autonomía
hasta 6 meses



Espacio para
tarjeta de memoria
hasta 64Gb



DESCARGAR
Ficha técnica



+ CABLE FLAT DE CARGA
ULTRASLIM FLEXIBLE

Carga por USB con cable FLAT Ultraslim (Cable incluido) Batería: 4500mAh - 21700 - 7V

6 MESES DE AUTONOMÍA



AÑADE EL TIMBRE SGR-011
PARA ESCUCHAR EL TIMBRE
SIN NECESIDAD DE MOVIL



DESCARGAR
Ficha técnica

Ref

PVPR

SGR-011

23,76€

Convierte tu timbre con cámara en
VIDEOPORTERO

CON LA PASTILLA PULSADOR PARA
CERRADURAS ELECTRÓNICAS
CONTR-056



VISUALIZADOR MIRILLA CON PANTALLA

ALIMENTACIÓN POR
USB O PILAS AAA

*** NO DISPONE DE
• WIFI / BLUETOOTH**

NEW!



MIRILLA DIGITAL CON PANTALLA

Ref

PVPR

SGR-009

109,80€



DESCARGAR
Ficha técnica



**AUMENTA LA SEGURIDAD
EN TU HOGAR.**

**Toma fotos o video
AUTOMÁTICAMENTE**

Al pulsar el timbre de la cámara,
automáticamente la cámara hace
una foto o graba video.



Función
timbre



Visión
infrarrojo



Foto/video



AAA
Batería
(NO INCLUIDA)



Ángulo
166°



Fácil
instalación



Función
no molestar



Espacio para
tarjeta micro SD
(NO INCLUIDA)

Mirilla digital con pantalla HD



COMPATIBLE
CON APP **tuya**

FÁCIL INSTALACIÓN
Montaje en superficie

SENSOR PIR
DE MOVIMIENTO



Carga por USB con cable FLAT Ultraslim 
(Cable incluido) **Batería:** 8000mAh 5V 2A
6 MESES DE AUTONOMÍA

MIRILLA DIGITAL PARA PUERTA CON
PANTALLA HD 4.4"

REF
SGR-034

PVPR
398,70

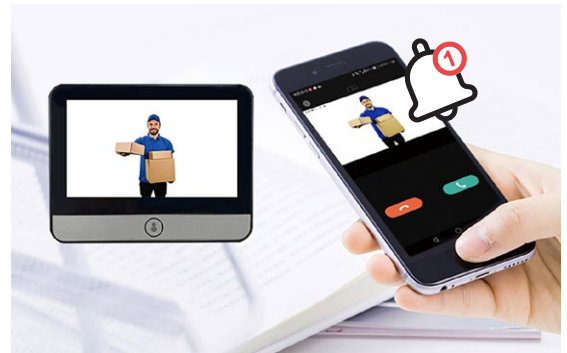

• Función de videollamada por interfono.

Cuando el visitante pulse el timbre, su teléfono recibirá la notificación, pulse la notificación y podrá realizar una videollamada en tiempo real al visitante.

• Visión nocturna

Cuando la luz ambiental sea inferior a 0,2 lux, se activará automáticamente la visión nocturna.

• Mando a distancia para móvil:

Mantenga los riesgos de seguridad fuera de su puerta.

• Gestión multiusuario:

Un dispositivo puede admitir varios usuarios.

• Detección de movimiento:

Foto, vídeo y alarma remota automáticos.

• Pantalla a color incorporada:

Se puede ver la puerta de un vistazo.

• Aspecto de aleación de aluminio:

• Antigangas y antirrobo

Almacenamiento de fotos en la nube:

• Fotos de almacenamiento en la nube APP móvil

• Cámara gran angular:

El ángulo de visión es amplio, y la situación fuera de la puerta es clara de un vistazo.

• Video portero monitoreo en tiempo real:

Usted puede interactuar con la persona en frente de la puerta, incluso cuando usted está fuera.

• Visión nocturna por infrarrojos:

Resuelve completamente el problema de no poder ver el exterior de la puerta por la noche.

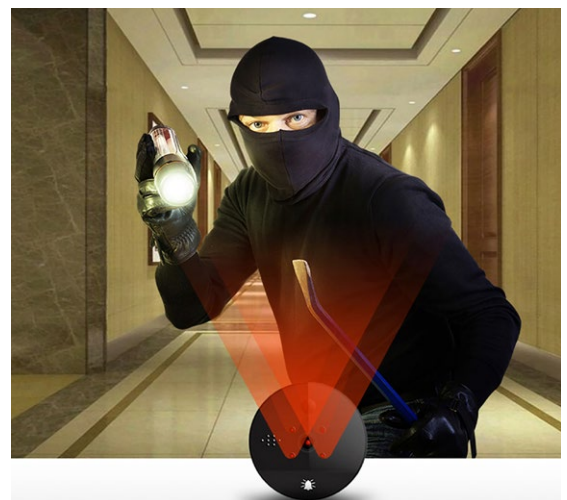

Función
timbre



Visión
infrarrojo



Foto/vídeo



Batería
8000mAh



Ángulo
166°



Fácil
instalación



Función
no molestar



Espacio para
tarjeta micro SD
(NO INCLUIDA)



Secadores

NEW!



70-80db

SECADO RÁPIDO Y SILENCIOSO

Ref

PVPR

SECAMANOS

850W

SEC-001

47,88 €



Temp del aire: 38°C ± 15°C
Distancia detección: >50mm
Tiempo: < 5sec



NEW!



70-80db



SECADO RÁPIDO Y SILENCIOSO

SECAMANOS BLANCO

1200W

SEC-002

105,30 €



Temp del aire: 60°C ± 20°C
Velocidad de viento: >30m/seg
Distancia de actuación: >140mm
Tiempo: <12sec



Botón cambio
aire frío / caliente

Luz LED indicador
aire caliente/frío



NEW!



70-80db



SECADO RÁPIDO Y SILENCIOSO

SECAMANOS NEGRO

1200W

SEC-003

116,70 €



Temp del aire: 60°C ± 20°C
Velocidad de viento: >30m/seg
Distancia de actuación: >140mm
Tiempo: <12sec





Extractores



Ultra silencioso - Ø100mm

Ref

PVPR

EXTRACTOR SILENT VACUUM V-1 BLANCO 4" 15W 180m³/h 36dB EXT-001 21,51€

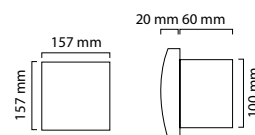

Ultra silencioso - Ø100mm

ANTI-RETORNO OLORES

EXTRACTOR SILENT VACUUM V-2 BLANCO 4" 15W 70m³/h 30dB EXT-002 58,38€

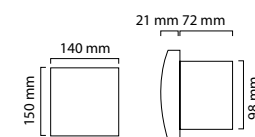

Ultra silencioso - Ø100mm

ANTI-RETORNO OLORES

EXTRACTOR SILENT VACUUM V-3 BLANCO 4" 12W 95m³/h 34dB EXT-003 41,52€

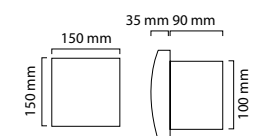

CON TEMPORIZADOR



Ultra silencioso - Ø100mm - CON TEMPORIZADOR 1-25MIN ANTI-RETORNO OLORES

EXTRACTOR SILENT VACUUM V-4 12W 70m³/h 30dB EXT-004 87,06€

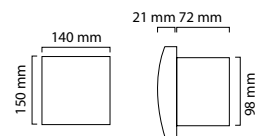

CON TEMPORIZADOR



Ultra silencioso - Ø102mm - CON TEMPORIZADOR 1-30MIN ANTI-RETORNO OLORES

EXTRACTOR SILENT VACUUM V-5 12W 66m³/h 39dB EXT-005 52,35€

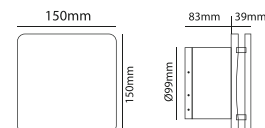

POLÍTICA DE DEVOLUCIONES

No se aceptarán devoluciones de materiales transcurridos 30 días desde su compra.

Los retornos se efectuarán a portes pagados, excepto aquellos que se realicen por error de **ATMOSS S.L.**, rogando que se realicen por la misma agencia por la cual se expidieron.

Toda devolución dentro de los plazos establecidos y previamente aceptada, llevará implícito un pedido de compensación.

No se aceptará la devolución en los siguientes casos:

A. Materiales no fabricados o comercializados por **ATMOSS S.L**

B. Material en buen estado que esten descatalogados.

C. Materiales en buen estado que hayan sido usados con anterioridad a la devolución.

D. Materiales que hayan sido manipulados.

E. Devoluciones de productos en buen estado con malas condiciones físicas de los embalajes.

F. Material en buen estado cuyo suministro supera los seis meses de la fecha de facturación.

G. En caso de una devolución con anterioridad al plazo mencionado en el apartado F., se aplicará un 15% de depreciación al material.

H. Para realizar una propuesta de devolución es necesario indicar el número de factura o albarán del material que se pretende devolver.

Si el comprador acredita devolver material por fallos técnicos del mismo o mal funcionamiento, será necesaria la comprobación técnica por **ATMOSS S.L** del material o de la instalación donde estuviera montado.

A. El proceso de comprobación del material puede durar hasta 15 días tras su recepción.

B. En caso de confirmar fallo del material, se le compensará al comprador (mediante abono o sustitución gratuita del material adquirido) sin que pueda exigirse daño o perjuicios de clase alguna.

C. Si por diversos motivos, la reposición de un mate-

rial ha de ser adelantada a la recepción del mismo, el albarán emitido por **ATMOSS S.L** se realizará CON CARGO.

A. El proceso de comprobación del material puede durar hasta 15 días tras su recepción.

B. En caso de confirmar fallo del material, se le compensará al comprador (mediante abono o sustitución gratuita del material adquirido) sin que pueda exigirse daño o perjuicios de clase alguna.

C. Si por diversos motivos, la reposición de un material ha de ser adelantada a la recepción del mismo, el albarán emitido por **ATMOSS S.L** se realizará CON CARGO. Tras la verificación de las devoluciones se realizará su respectivo abono o sustitución, siempre que proceda.

Una vez superadas las 48 horas de entrega del material, **ATMOSS S.L** no aceptará reclamaciones relativas a roturas de material, errores en las cantidades o errores de modelos. En caso de notificar en el justificante de entrega por parte de la transportadora que la mercancía está sujeta a revisión, el plazo se extenderá a 7 días naturales siguientes a la fecha en la que se efectuó el suministro.

CONDICIONES DE GARANTÍA

ATMOSS S.L trabaja con fabricantes de alta calidad, y exige que todos sus productos se desarrollen con los más altos niveles de fiabilidad y eficiencia.

Los productos ofrecidos de **ATMOSS S.L**, tienen 3 años de garantía, desde la entrega de los mismos, desde la fecha de compra (fecha de factura).

La garantía de los productos vendidos por **ATMOSS S.L** se presta y establece en virtud de la normativa contenida en la LEY 23/2003, del 10 de julio, de garantías en la Venta de Bienes de Consumo, marco legal que tiene por objeto facilitar al consumidor distintas opciones.

ATMOSS S.L, aplicará la presente garantía cuando cualquier unidad no funcione o lo haga incorrectamente. El personal de **ATMOSS S.L** procedería entonces a los test pertinentes a fin de terminar las causas de tales anomalías.

ATMOSS S.L, gestionará la reposición o reparación del material en el menor plazo de tiempo posible, una vez se determine que las causas del mal funcionamiento del producto tienen su origen en la fabricación.

Siempre, el producto a reparar o sustituir, deberá corresponder al enviado por **ATMOSS S.L**. Adjuntando en el albarán de entrega y/o factura. **ATMOSS S.L** atenderá a los citados servicios por es su naturaleza como Importador y Distribuidor para todo el territorio Español.

La garantía de **ATMOSS S.L** excluye los siguientes puntos:

- El desgaste o uso indebido de horas y averías producidas por una incorrecta instalación o manipulación y almacenaje. El fallo por desgaste, uso indebido y negligencia antes o durante el uso.
- Cualquier tipo de reclamación por pérdida natural de luminosidad o degradación de luminosidad del chip led **ATMOSS S.L**, también se excluye la garantía.
- **ATMOSS S.L** no se hará cargo de posibles daños que puedan resultar por mal uso, instalación no profesional, o mal funcionamiento como corto circuito. La garantía no será válida en caso de factores externos al uso normal del producto, tales como subidas o bajadas de tensión, utilización de accesorios inadecuados o prohibidos por el fabricante, o manejo incorrecto por parte del cliente o terceras personas no autorizadas por los fabricantes.
- Esta garantía limitada no cubre defectos que ocurran debido a una instalación inapropiada de ningún tipo. **ATMOSS S.L** no cubrirá los gastos de mano de obra adicional o garantías como trabajo

asociado con reemplazos del producto. Este documento de garantía representa la única garantía expresa o implícita y no existe otro tipo de garantía.

- Otros signos de aparente trato incorrecto anularán también la presente garantía.
- Así mismo, nos reservamos el derecho a estudiar cada producto devuelto por especialistas independientes quedando la garantía exenta en caso de demostrarse por las autoridades competentes que la rotura ha sido causada por el cliente o usuario, así como la rotura parcial del producto para forzar el uso de la garantía para la devolución o reintegro del producto. En caso de ser así, los gastos para demostración de culpa correrán a cargo del cliente. Todos los aspectos de esta garantía no recogidos en esta ley 23/2003, será de aplicación el régimen contenido en la Ley 7/1996, del 15 de Enero, de Ordenación del Comercio Minorista.
- Las imágenes y descripciones de los productos **ATMOSS S.L**, son reales, salvo error tipográfico

Reclamaciones

Como consecuencia del transporte, se aceptarán en un plazo de 3 días siguientes a la recepción de la mercancía, acompañando fotocopia del albarán de la agencia de transporte en el que se consistirán la incidencia de rotura, mal estado, etc.

Toda reclamación dará lugar a un expediente de incidencia que llevará un seguimiento de las causas al objeto de realizar las oportunas acciones correctoras.

Pago de facturas

ATMOSS S.L se reserva el derecho de propiedad sobre las mercancías, incluso frente a terceros, en tanto no se cumpla íntegramente el pago del importe.

Los pagos se harán siempre efectivos en los términos pactados con el cliente. Los gastos que se originen como consecuencia de la devolución de efectos girados serán a cargo del cliente, así como los gastos financieros ocasionados por cualquier modificación.

ATMOSS S.L se reserva el derecho a suspender cualquier envío de material por impago parcial o total de algún suministro anterior.

Jurisdicción

Para toda cuestión, diferencia, interpretación, etc., que pudiera surgir, las partes se someten expresamente a la jurisdicción y competencia de los Juzgados y Tribunales de Alicante.

ATMOSS[®]



Calle los Mecánicos, 5
03130 Pol. Ind. Santa Pola (Alicante) España
Tel. +34 966 693 404 / 865 664 858

atmoss@atmoss.es
www.atmoss.es