

ATMOSS[®]

TODO LO QUE NECESITAS
EN **UN SOLO CATÁLOGO**



ILUMINACIÓN



MECANISMOS



MATERIAL ELÉCTRICO



DOMÓTICA



CATÁLOGO GENERAL
2026

ATMOSS[®]

LIGHTING

Nos ubicamos en el Polígono de Santa Pola, ocupando un espacio de 6000m² distribuidos en 10 naves industriales. Estas modernas instalaciones destacan por su amplitud y luminosidad, creando un entorno propicio para la eficiencia operativa.

Cada una de las 10 naves ha sido diseñada con precisión para optimizar el almacenamiento y la gestión logística. Este extenso espacio nos permite mantener **más de 2000 referencias en stock**, garantizando una oferta diversificada y una respuesta ágil a las necesidades del mercado.

La iluminación en nuestras instalaciones ha sido cuidadosamente planificada para asegurar una visibilidad óptima, contribuyendo a un ambiente de trabajo cómodo y productivo. En Atmoss Electric, nuestras instalaciones no solo reflejan modernidad y eficiencia, sino que también respaldan nuestro compromiso con la excelencia y la disponibilidad inmediata de productos para nuestros clientes.





NUESTRAS *INSTALACIONES*

ALMACÉN

6000m² repartidos en más de 10 naves, con más de 2000 referencias en stock.



Iluminación profesional de calidad, responsable con el entorno

ATMOSS es una empresa de iluminación profesional creada en 2007 para ofrecer a los técnicos los mejores productos del sector de la iluminación.

Ofrecemos un servicio de calidad que se manifiesta tanto en nuestros productos como en nuestro equipo humano, siempre innovando. De este modo los profesionales pueden tener la confianza de sentirse seguros recurriendo a Atmoss para dar soluciones a sus clientes. Este compromiso de calidad y servicio va unido a una gran responsabilidad por el medioambiente.

Departamento técnico

Nuestro departamento técnico te asesorará y resolverá tus dudas sobre cualquiera de nuestros productos, con la garantía y rapidez de un gran equipo profesional.



Visita nuestra página web
www.atmoss.es

Puedes descargar las fichas técnicas
desde catálogo online.



Haga click en la flecha azul para
DESCARGAR LA FICHA TÉCNICA





SIMBOLOGÍA

• Metros tira de LED

50 M Metros de la bobina

• Almacenamiento

1 Unidad de producto por caja

Fuente de alimentación de **ALTA CALIDAD**

LIFUD
Led Driver

Batería de **ALTA DURACIÓN** y **BUENA CALIDAD.**
- Mayor vida útil

Todas nuestras baterías son de Fosfato de Hierro Litio (LiFePO4), son un tipo de baterías recargable de Ión Litio.

La esperanza de vida del LiFePO4 es hasta **10 veces superior** al tiempo de vida de las baterías de plomo ácido y algunos tipos de baterías de ión litio.



• Grado de protección IP

IP 20 IP20: Evita la entrada de grandes objetos.

IP 42 IP42: Protegido contra la entrada de cualquier objeto y goteo de agua.

IP 65 IP65: Resiste la entrada de chorros de agua.

IP 66 IP66: Protegido frente a inmersiones en aguas breves.

IP 67 IP67: Protegido frente a inmersiones en aguas breves.

IP 68 IP68: Capaz de resistir inmersiones completas y continuadas en agua.

• Características Iluminación

≥90 CRI Índice de reproducción cromática: Capacidad de una fuente de luz para mostrar los colores de una manera real, con un rango de 0-100 tomando como referencia la luz natural.

UGR <19 UGR: Índice de deslumbramiento unificado.

>0,5 FP FP: Factor de potencia

0-10V Sistema de variación de intensidad (Dimmable triac): Adaptados a las especificaciones de cada producto, desde dimming mediante pulsos (PWM), atenuación de intensidad o modos analógicos (0-10V)

1018 Lm/m Flujo luminoso: Potencia lumínica emitada por 1m. de tira

>0,9 FP FP: Factor de potencia

RGB Reproduce los colores rojo, verde y azul consiguiendo millones de combinaciones.

160° Ángulo de apertura: Ángulo de apertura del haz de luz

3CCT: Posibilidad de cambiar el color de luz entre **3200K-4200K-5000K** 3 colores de luz en la misma luminaria

RGBw Combina todo el espectro del RGB con la posibilidad de añadir tonos pastel gracias al canal blanco cálido.

360° Ángulo de apertura: Ángulo de apertura de sensor

• Conexiones

WiFi WiFi. Permite control por WiFi. Mediante la app TUYA.

Bluetooth Conexión Bluetooth. Permite control por bluetooth.

RF Permite control por radiofrecuencia.

POE Sistema POE. Es una tecnología para transmisión de datos por cable Ethernet LAN

tuya Tuya. La aplicación oficial para Home Assistant. Controla tu hogar en cualquier parte del mundo desde la App.

• Características

PIR Sensor de movimiento PIR. Detecta movimiento dentro de su campo de acción entre 8 y 10 metros

Temporizador. Posibilidad de regular el tiempo de encendido.

Control inteligente de luz. Regulación de la luz en relación a la luz ambiente.

Mando a distancia. Incluye mando a distancia.

• Características domótica

360° Movimiento horizontal. Capacidad de 360° en movimiento horizontal.

120° Movimiento vertical. Capacidad de 120° en movimiento vertical.

Grabación de video y captura de imágenes. Grabación de video y captura de imágenes.

Visión nocturna. Disponible de visión nocturna.

• Tensión

230 V Tensión de funcionamiento del producto.

24 V

12 V

• Temperatura de color:

Indicador de temperatura de color de la fuente de luz.





Índice

08	Lámparas	277	Lámparas de mesa
36	Aros	280	Domótica
52	Apliques	336	Mecanismos
94	Downlight	372	Material eléctrico
120	Luminaria lineal	404	Ventilador
124	Track light	406	Aparamenta
140	Panel	438	Cajas de distribución
148	Tubos led - Pantallas		
156	Regleta Led		
162	Tira de Led		
202	Proyector exterior		
214	Solar		
248	Farola		
256	Emergencia		
262	Sensores		
274	Linternas		

DESCARGA NUESTROS
CATÁLOGOS DESDE EL QR



Haz click aquí para
ver todos nuestros
catálogos





DOMÓTICA HOUSE SMART

Tuya Smart es la **aplicación más utilizada** en el sector del hogar inteligente.

Su funcionamiento está basado en la gestión de dispositivos inteligentes, proporcionando un control total y remoto, además de configurar escenarios predeterminados que aumentan la usabilidad y calidad de la APP.

SEGURIDAD

Se trata de la configuración de una red de seguridad compuesta por **alarmas, detectores, cerradura inteligente, cámaras...** Permite controlar cualquier tipo de intrusión mediante cámaras de vigilancia o alarmas personales.

PERSIANAS

Controla tu persiana mediante smartphone, mando, pulsador,...

ENCHUFES

La mejor forma de **controlar el encendido y apagado de dispositivos** conectados a la electricidad. Puede monitorizar el **ahorro de energía**, proteger contra sobretensiones, desconectar la alimentación de la red eléctrica **mediante tu smartphone**.

PUERTA GARAJE

Automatiza tu puerta del garaje, abre tu puerta sin necesidad de bajar del vehículo.

ILUMINACIÓN

Crea diferentes ambientes con nuestras lámparas WiFi. Controla el encendido o apagado, la regulación o el color desde la App.

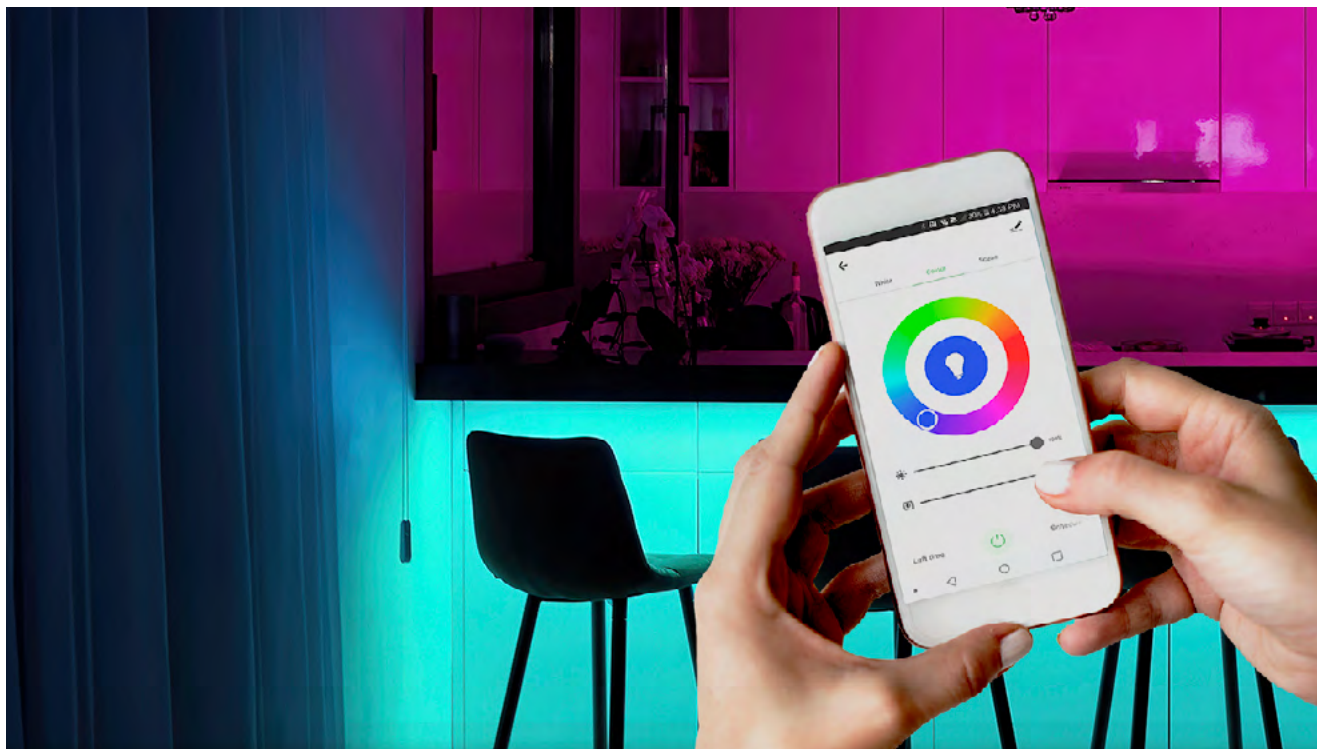

VENTAJAS de domotizar una vivienda

- Ayuda para personas con movilidad reducida.
- Ahorro energético.
- Mejor confort.
- Fácil instalación.
- Domotiza tu vivienda a un precio reducido.
- Amplia la cobertura WiFi en tu vivienda.





Serie Lámparas & Aros

Iluminación



Serie Bombillas Vintage

NEW!

SERIE
VINTAGE



BLED-454



BLED-455

					°K	Ref	PVPR
Vintage Transparente	A60	E27 4W	500Lm	↓	2700K	BLED-454	4,38€
Vintage Ámbar	A60	E27 4W	500Lm	↓	2700K	BLED-455	4,08€



60mm

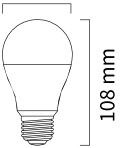

BLED-457



BLED-456

					°K	Ref	PVPR
Vintage Transparente	S14	E27 4W	500Lm	↓	2700K	BLED-457	3,66€
Vintage Ámbar	S14	E27 4W	500Lm	↓	2700K	BLED-456	4,02€



45mm

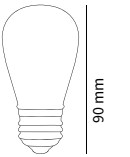

BLED-458



BLED-459

					°K	Ref	PVPR
Vintage Ámbar Mini esférica	G45	E27 4W	500Lm	↓	2700K	BLED-458	3,96€
Vintage Ámbar Mini esférica	G45	E14 4W	500Lm	↓	2700K	BLED-459	3,96€



45MM

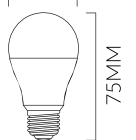

BLED-461



BLED-460

					°K	Ref	PVPR
Vintage Transparente Edison	ST64	E27 4W	500Lm	↓	2700K	BLED-461	4,59€
Vintage Ámbar Edison	ST64	E27 4W	500Lm	↓	2700K	BLED-460	5,34€



64mm



BLED-462

					°K	Ref	PVPR
Vintage Ámbar Vela	C35	E14 4W	500Lm	↓	2700K	BLED-462	3,96€



35mm

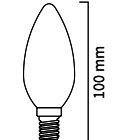



					°K	Ref	PVPR
Vintage Transparente Vela Ilama	C35	E14 4W	500Lm	↓	2700K	BLED-464	3,63€
Vintage Ámbar Vela Ilama	C35	E14 4W	500Lm	↓	2700K	BLED-463	3,96€

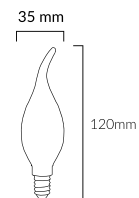

					°K	Ref	PVPR
Vintage Transparente Globo	G80	E27 4W	500Lm	↓	2700K	BLED-466	5,01€
Vintage Ámbar Globo	G80	E27 4W	500Lm	↓	2700K	BLED-465	5,52€

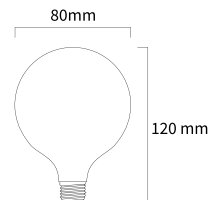

					°K	Ref	PVPR
Vintage Transparente Globo	G95	E27 4W	500Lm	↓	2700K	BLED-468	5,46€
Vintage Ámbar Globo	G95	E27 4W	500Lm	↓	2700K	BLED-467	6,84€

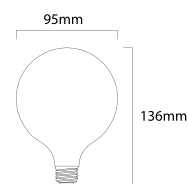

					°K	Ref	PVPR
Vintage Transparente Globo	G125	E27 4W	500Lm	↓	2700K	BLED-470	6,96€
Vintage Ámbar Globo	G125	E27 4W	500Lm	↓	2700K	BLED-469	9,12€

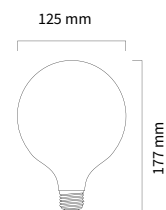

					°K	Ref	PVPR
Vintage Ámbar Globo Gold	G80	E27 4W	500Lm	↓	2700K	BLED-471	10,86€

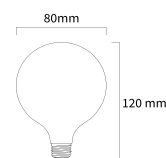

					°K	Ref	PVPR
Vintage Ámbar Globo Gold	G90	E27 4W	500Lm	↓	2700K	BLED-472	11,82€

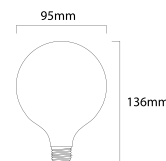

					°K	Ref	PVPR
Vintage Ámbar Globo Gold	G125	E27 4W	500Lm	↓	2700K	BLED-473	14,16€

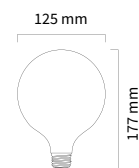

Casquillo E27 acabado oro



Led en Espiral

* Según la nueva normativa ERP ha habido un cambio en la medición de Lúmenes y vatios, pero sigue emitiendo la misma cantidad de luz. A medida que vayan entrando los nuevos modelos con ERP se irá actualizando en catálogo y cajas de color. Puede haber variación respecto a la caja del producto (comprobar en ficha técnica), todos los datos en catálogo están correctos salvo error tipográfico.



Serie Lámparas ECO



Menos consumo
Misma eficiencia



Acabado de color
de la lámpara



Dimmable con las
pastillas pág.37



Mate Ambar Transparente

					°K	Ref	PVPR
Vintage Vela Transparente	DIMMABLE TRIAC	C35	E14 5W 700Lm	3200K	3200K	BLED-384	6,60€
Vintage Vela Ambar	DIMMABLE TRIAC	C35	E14 5W 700Lm	3200K	3200K	BLED-385	6,96€
Vintage Vela Mate	DIMMABLE TRIAC	C35	E14 5W 700Lm	3200K	3200K	BLED-386	7,02€



SOLO
REGULACIÓN TRIAC

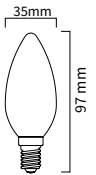

Mate Ambar Transparente

					°K	Ref	PVPR
MiniEsférica Transparente	DIMMABLE TRIAC	G45	E14 6W 900Lm	3200K	3200K	BLED-387	6,60€
MiniEsférica Ambar	DIMMABLE TRIAC	G45	E14 6W 900Lm	3200K	3200K	BLED-388	6,96€
MiniEsférica Mate	DIMMABLE TRIAC	G45	E14 6W 900Lm	3200K	3200K	BLED-389	7,02€



SOLO
REGULACIÓN TRIAC

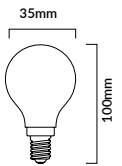

Mate Ambar Transparente

					°K	Ref	PVPR
MiniEsférica Transparente	DIMMABLE TRIAC	G45	E27 6W 900Lm	3200K	3200K	BLED-390	6,78€
MiniEsférica Ambar	DIMMABLE TRIAC	G45	E27 6W 900Lm	3200K	3200K	BLED-391	7,14€
MiniEsférica Mate	DIMMABLE TRIAC	G45	E27 6W 900Lm	3200K	3200K	BLED-392	7,20€



SOLO
REGULACIÓN TRIAC

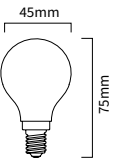

Mate Ambar Transparente

					°K	Ref	PVPR
Vintage Transparente	DIMMABLE TRIAC	A60	E27 10W 1300Lm	3200K	3200K	BLED-405	9,54€
Vintage Ambar	DIMMABLE TRIAC	A60	E27 10W 1300Lm	3200K	3200K	BLED-406	10,14€
Vintage Mate	DIMMABLE TRIAC	A60	E27 10W 1300Lm	3200K	3200K	BLED-407	10,26€



SOLO
REGULACIÓN TRIAC

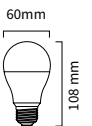

Ambar Transparente

					°K	Ref	PVPR
Vintage Edison Transparente	DIMMABLE TRIAC	ST64	E27 12W 1600Lm	3200K	3200K	BLED-408	13,44€
Vintage Edison Ambar	DIMMABLE TRIAC	ST64	E27 12W 1600Lm	3200K	3200K	BLED-409	14,40€



SOLO
REGULACIÓN TRIAC

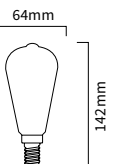



Blanco Ambar Transparente

					°K	Ref	PVPR
Vintage Globo Transparente	DIMMABLE TRIAC	G95	E27	12W	1700Lm	3200K	BLED-410 15,42€
Vintage Globo Ambar	DIMMABLE TRIAC	G95	E27	12W	1700Lm	3200K	BLED-411 16,56€
Vintage Globo Blanco	DIMMABLE TRIAC	G95	E27	12W	1700Lm	3200K	BLED-412 16,92€



SOLO REGULACIÓN TRIAC

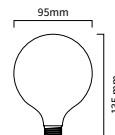

Opal Ambar Transparente

						°K	Ref	PVPR
Vintage Globo Transparente	DIMMABLE TRIAC	G125	E27	12W	1700Lm	3200K	BLED-413 17,64€	
Vintage Globo Ambar	DIMMABLE TRIAC	G125	E27	12W	1700Lm	3200K	BLED-414 18,96€	
Vintage Globo Blanco	DIMMABLE TRIAC	G125	E27	12W	1700Lm	3200K	BLED-415 19,26€	



SOLO REGULACIÓN TRIAC

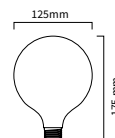

Acabado de color de la lámpara



Mate Ambar Transparente

						°K	Ref	PVPR
Vintage Vela Transparente		C35	E14	4W	450Lm	2700K	BLED-161 4,56€	
Vintage Vela Transparente		C35	E14	4W	450Lm	4200K	BLED-162 4,56€	
Vintage Vela Transparente		C35	E14	4W	450Lm	5000K	BLED-163 4,56€	
Vintage Vela Ambar		C35	E14	4W	450Lm	3200K	BLED-164 5,52€	
Vintage Vela Mate		C35	E14	4W	450Lm	3200K	BLED-166 6,93€	
Vintage Vela Ambar	DIMMABLE TRIAC	C35	E14	4W	350Lm	3200K	BLED-165 7,20€	



BLED-165

SOLO REGULACIÓN TRIAC

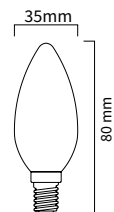

Mate Ambar Transparente

						°K	Ref	PVPR
Vintage Mini Esférica Transparente		G45	E14	4W	450Lm	2700K	BLED-167 5,67€	
Vintage Mini Esférica Transparente		G45	E14	4W	450Lm	4200K	BLED-168 5,67€	
Vintage Mini Esférica Transparente		G45	E14	4W	450Lm	5000K	BLED-169 5,67€	
Vintage Mini Esférica Ambar		G45	E14	4W	450Lm	3200K	BLED-173 6,93€	
Vintage Mini Esférica Mate		G45	E14	4W	400Lm	3200K	BLED-175 5,85€	

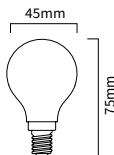

Mate Ambar Transparente

						°K	Ref	PVPR
Vintage Mini Esférica Transparente		G45	E27	4W	450Lm	2700K	BLED-170 5,16€	
Vintage Mini Esférica Transparente		G45	E27	4W	450Lm	4200K	BLED-171 5,67€	
Vintage Mini Esférica Transparente		G45	E27	4W	450Lm	5000K	BLED-172 5,67€	
Vintage Mini Esférica Ambar		G45	E27	4W	450Lm	3200K	BLED-174 6,93€	
Vintage Mini Esférica Mate		G45	E27	4W	400Lm	3200K	BLED-176 5,85€	

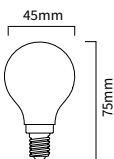

Mate Ambar Transparente

						°K	Ref	PVPR
Vintage Stand Transparente		A60	E27	8W	850Lm	2700K	BLED-177 7,89€	
Vintage Stand Transparente		A60	E27	8W	850Lm	4200K	BLED-178 7,89€	
Vintage Stand Transparente		A60	E27	8W	850Lm	5000K	BLED-179 7,89€	
Vintage Stand Ambar		A60	E27	8W	850Lm	3200K	BLED-237 9,21€	
Vintage Stand Mate		A60	E27	8W	850Lm	3200K	BLED-238 8,58€	

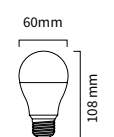

* Según la nueva normativa ERP ha habido un cambio en la medición de Lúmenes y vatios, pero sigue emitiendo la misma cantidad de luz.

A medida que vayan entrando los nuevos modelos con ERP se irá actualizando en catálogo y cajas de color.

Puede haber variación respecto la caja del producto (comprobar en ficha técnica), todos los datos en catálogo están correctos salvo error tipográfico.



Ambar Transparente

			°K	Ref	PVPR
Vintage Edison Transparente	ST64	E27 8W	850Lm 2700K	BLED-180	9,60€
Vintage Edison Transparente	ST64	E27 8W	850Lm 4200K	BLED-181	9,60€
Vintage Edison Transparente	ST64	E27 8W	850Lm 5000K	BLED-182	9,60€
Vintage Edison Ambar	ST64	E27 8W	850Lm 3200K	BLED-183	10,77€

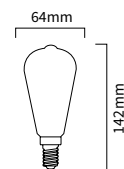

Opal Ambar Transparente

			°K	Ref	PVPR
Vintage Globo Transparente	100	G95 E27 8W	850Lm 2700K	BLED-184	10,65€
Vintage Globo Transparente	100	G95 E27 8W	850Lm 4200K	BLED-185	10,65€
Vintage Globo Transparente	100	G95 E27 8W	850Lm 5000K	BLED-186	10,65€
Vintage Globo Ambar	50	G95 E27 8W	850Lm 3200K	BLED-187	12,72€
Vintage Globo Opal	50	G95 E27 8W	850Lm 3000K	BLED-239	11,01€
Vintage Globo Opal	50	G95 E27 8W	850Lm 4000K	BLED-240	11,01€

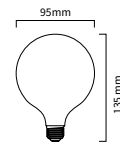

Opal Ambar Transparente

			°K	Ref	PVPR
Vintage Globo Transparente		G125 E27 8W	850Lm 2700K	BLED-188	13,92€
Vintage Globo Transparente		G125 E27 8W	850Lm 4200K	BLED-189	13,92€
Vintage Globo Transparente		G125 E27 8W	850Lm 5000K	BLED-190	13,92€
Vintage Globo Ambar		G125 E27 8W	850Lm 3200K	BLED-191	15,24€
Vintage Globo Ambar DIMMABLE TRIAC		G125 E27 8W	850Lm 3200K	BLED-192	16,92€
Vintage Globo Opal		G125 E27 8W	850Lm 3200K	BLED-241	14,13€
Vintage Globo Opal		G125 E27 8W	850Lm 4200K	BLED-242	14,13€



BLED-192
SOLO REGULACIÓN TRIAC
pág.37

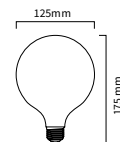

Opal Transparente

			°K	Ref	PVPR
Vintage Stand Transparente	A70	E27 17W	2452Lm 3200K	BLED-257	19,74€
Vintage Stand Transparente	A70	E27 17W	2452Lm 4200K	BLED-258	19,74€
Vintage Stand Transparente NEW!	A70	E27 17W	2452Lm 5000K	BLED-261	19,74€
Vintage Stand Opal	A70	E27 17W	2452Lm 3200K	BLED-259	20,64€
Vintage Stand Opal	A70	E27 17W	2452Lm 4200K	BLED-260	20,64€

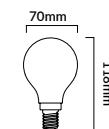

Vela



			°K	Ref	PVPR
Vela Samsung Led	E14	6W	540Lm 3200K	BLED-216	2,97€
Vela Samsung Led	E14	6W	540Lm 4200K	BLED-217	2,97€
Vela Samsung Led	E14	6W	540Lm 5000K	BLED-218	2,97€

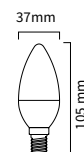

			°K	Ref	PVPR
Vela Samsung Led DIMMABLE TRIAC	E14	7W	630Lm 3200K	BLED-232	6,24€
Vela Samsung Led DIMMABLE TRIAC	E14	7W	630Lm 4200K	BLED-233	6,24€
Vela Samsung Led DIMMABLE TRIAC	E14	7W	630Lm 5000K	BLED-234	6,24€



SOLO REGULACIÓN TRIAC
pág.37

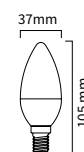



Serie SAMSUNG LED Inside



MiniEsférica

°K Ref PVPR

Used SAMSUNG LED Chips



Miniesférica Samsung led	G45 E14 6W 470Lm	3200K	BLEED-203	2,88€
Miniesférica Samsung led	G45 E14 6W 470Lm	4200K	BLEED-204	2,88€
Miniesférica Samsung led	G45 E14 6W 470Lm	5000K	BLEED-205	2,88€
Miniesférica Samsung led DIMMABLE TRIAC	G45 E14 6W 540Lm	3200K	BLEED-255	7,05€
Miniesférica SMD led DIMMABLE TRIAC	G45 E14 6W 540Lm	4200K	BLEED-100	7,05€
Miniesférica Samsung led	G45 E27 6W 540Lm	3200K	BLEED-206	2,88€
Miniesférica Samsung led	G45 E27 6W 540Lm	4200K	BLEED-207	2,88€
Miniesférica Samsung led	G45 E27 6W 540Lm	5000K	BLEED-208	2,88€
Miniesférica SMD led DIMMABLE TRIAC	G45 E27 6W 540Lm	3200K	BLEED-256	7,05€
Miniesférica SMD led DIMMABLE TRIAC	G45 E27 6W 540Lm	4200K	BLEED-101	7,05€

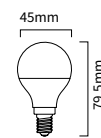

Used SAMSUNG LED Chips

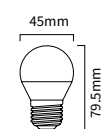

6w 160° 230v >0,7 FP IP 40 100 BLED-255/100/256/101 SOLO REGULACIÓN TRIAC pág.37

Standar

°K Ref PVPR

Used SAMSUNG LED Chips



Standar Samsung led DIMMABLE TRIAC	220° A60 E27 10W 810Lm	3200K	BLEED-235	13,86€
Standar Samsung led DIMMABLE TRIAC	220° A60 E27 10W 810Lm	4200K	BLEED-226	13,86€
Standar Samsung led DIMMABLE TRIAC	220° A60 E27 10W 810Lm	5000K	BLEED-236	13,86€
Standar Samsung led	160° A60 E27 10W 930Lm	3200K	BLEED-209	4,53€
Standar Samsung led	160° A60 E27 10W 930Lm	4200K	BLEED-210	4,53€
Standar Samsung led	160° A60 E27 10W 930Lm	5000K	BLEED-211	4,53€
Standar Samsung led	240° A60 E27 12W 1200Lm	3200K	BLEED-212	5,79€
Standar Samsung led	240° A60 E27 12W 1200Lm	4200K	BLEED-213	5,79€
Standar Samsung led	240° A60 E27 12W 1200Lm	5000K	BLEED-214	5,79€
Standar Samsung led	160° A60 E27 14W 1500Lm	3200K	BLEED-060	6,15€
Standar Samsung led	160° A60 E27 14W 1500Lm	4200K	BLEED-075	6,15€
Standar Samsung led	160° A60 E27 14W 1500Lm	5000K	BLEED-061	6,15€
Standar Samsung led	160° A65 E27 17W 1900Lm	3200K	BLEED-130	14,49€
Standar Samsung led	160° A65 E27 17W 1900Lm	4200K	BLEED-076	14,49€
Standar Samsung led	160° A65 E27 17W 1900Lm	5000K	BLEED-077	14,49€

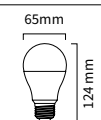
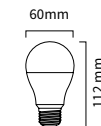
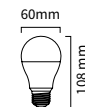

E27 10w 12w 14w 17w >0,9 FP 230v IP 40 100 BLED-235/226/236 SOLO REGULACIÓN TRIAC pág.37

Stand Led sensor

Con sensor crepuscular solar

°K Ref PVPR



Standar Led sensor crepuscular	A65 E27 12W 1200Lm	5000K	BLEED-129	16,59€
--------------------------------	--------------------	-------	-----------	--------

E27 12w 1200 Lm 200° 230v >0,9 FP IP 40 100 SENSOR DE LUZ

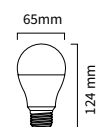

Con sensor de movimiento

°K Ref PVPR



Standar Led sensor movimiento	A60 E27 12W 1200Lm	5000K	BLEED-160	20,85€
-------------------------------	--------------------	-------	-----------	--------

E27 12w 1200 Lm 200° 230v >0,5 FP IP 20 100 SENSOR PIR DE MOVIMIENTO

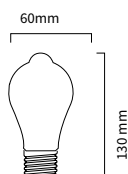



Bombilla standard
5CCT

5 en 1 CINCO TIPOS DE LUZ
EN LA MISMA LUMINARIA

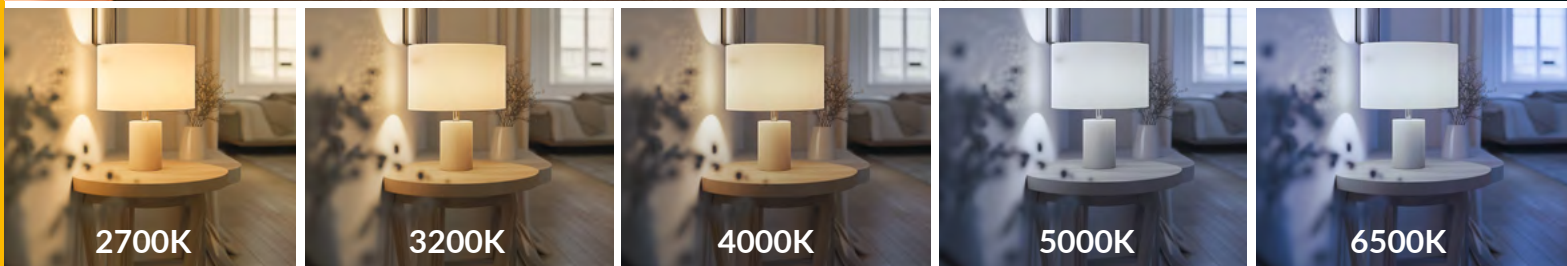

NEW!



SWITCH 5CCT
INTERRUPTOR

	Ref	PVPR
STANDARD A60 E27 11W	1100lm 5CCT	BLED-417 4,68€
STANDARD A60 E27 13W	1300lm 5CCT	BLED-418 5,64€
STANDARD A60 E27 16W	1600lm 5CCT	BLED-419 5,94€

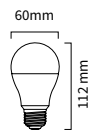

A60 E27 11w 13w 16w 180° 230v >0,5 FP IP 40 100
1100 Lm 1300 Lm 1600 Lm



SWITCH 5CCT
GIRATORIO

CREA EL AMBIENTE PERFECTO
FÁCIL CAMBIO DE COLOR

NEW!

+ Lúmenes
- Consumo



SWITCH 5CCT
GIRATORIO

	Ref	PVPR
STANDARD A65 E27 11W	1500lm 5CCT	BLED-273 6,45€

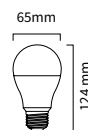

A65 E27 11w 1500 Lm 180° 230v >0,5 FP IP 20 100



Battery
Li-ion
LiFePO4

Batería integrada
alta duración
1600mAh

Bombillas con batería integrada

Ideal para cualquier situación

Bombilla led con batería integrada.

• Incluye gancho y adaptador de carga

• **Luz durante apagones:** La batería integrada asegura iluminación incluso cuando hay cortes de energía.

• **Fácil instalación:** Se usa como una bombilla o dicroica convencional, sin necesidad de instalaciones adicionales.

NEW!

Batería Li-ion
1600mAh
Lm emergencia
240Lm

1h de autonomía

	K	Ref	PVPR
BOMBILLA CON BATERÍA 7W E27 200°	5000K	BLED-270	11,40€

Consultar instrucciones en ficha técnica para características de uso

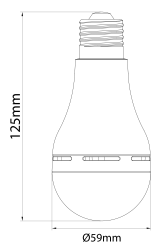

Dicroica led con batería integrada.

NEW!

Batería Li-ion
500mAh
Lm emergencia
60Lm

1h de autonomía

	K	Ref	PVPR
DICROICA CON BATERÍA 5W GU10 60°	4200K	DIC-110	13,56€

Consultar instrucciones en ficha técnica para características de uso

Li-ion LiFePO4
Batería integrada
alta duración
500mAh

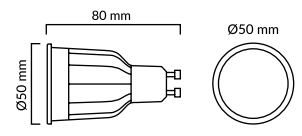

* Según la nueva normativa ERP ha habido un cambio en la medición de Lúmenes y vatios, pero sigue emitiendo la misma cantidad de luz. A medida que vayan entrando los nuevos modelos con ERP se irá actualizando en catálogo y cajas de color. Puede haber variación respecto a la caja del producto (comprobar en ficha técnica), todos los datos en catálogo están correctos salvo error tipográfico.

Lámparas Standar led

ALTA DURABILIDAD - ALTA EFICIENCIA

ALTA RESISTENCIA IP65



Instalar únicamente en posición vertical



				°K		Ref	PVPR
Standar led	20	A80	E27 30W	3200Lm	3200K	BLED-113	26,85€
Standar led	20	A80	E27 30W	3200Lm	4200K	BLED-108	26,85€
Standar led	20	A80	E27 30W	3200Lm	5000K	BLED-109	26,85€
Standar led	20	A100	E27 45W	4200Lm	3200K	BLED-114	39,78€
Standar led	20	A100	E27 45W	4200Lm	4200K	BLED-106	39,78€
Standar led	20	A100	E27 45W	4200Lm	5000K	BLED-107	39,78€
Standar led	12	A120	E27 60W	6500Lm	3200K	BLED-115	64,17€
Standar led	12	A120	E27 60W	6500Lm	4200K	BLED-104	64,17€
Standar led	12	A120	E27 60W	6500Lm	5000K	BLED-105	64,17€

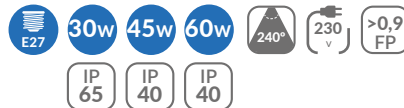
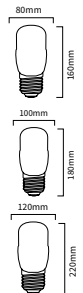

Instalar únicamente en posición vertical - INCLUYE ADAPTADOR E40-E27

				°K		Ref	PVPR
Standar led		A160	E40 80W	8720Lm	3200K	BLED-225	92,16€
Standar led		A160	E40 80W	8720Lm	4200K	BLED-135	92,16€
Standar led		A160	E40 80W	8720Lm	5000K	BLED-103	92,16€

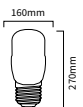

Tulip



Accepta cualquier posición de instalación

			°K	Ref	PVPR
Stand led SMD Tulip	360° A100	E27 40W	3600Lm	3200K	BLED-224 39,57€
Stand led SMD Tulip	360° A100	E27 40W	3600Lm	4200K	BLED-148 39,57€
Stand led SMD Tulip	360° A100	E27 40W	3600Lm	5000K	BLED-149 39,57€

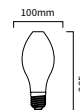

Used SAMSUNG LED Chips

Stand led SMD Tulip	300° A100	E27 60W	6500Lm	4200K	BLED-243 70,98€
Stand led SMD Tulip	300° A100	E27 60W	6500Lm	5000K	BLED-244 70,98€

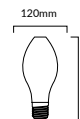

Globo



				°K	Ref	PVPR
Globo led	G80	E27 12W	1200Lm	3200K	BLED-078	10,47€
Globo led	G80	E27 12W	1200Lm	4200K	BLED-079	10,47€
Globo led	G80	E27 12W	1200Lm	5000K	BLED-080	10,47€
Globo led	G95	E27 15W	1500Lm	3200K	BLED-081	13,32€
Globo led	G95	E27 15W	1500Lm	4200K	BLED-082	13,32€
Globo led	G95	E27 15W	1500Lm	5000K	BLED-083	13,32€
Globo led	G120	E27 18W	1700Lm	3200K	BLED-084	20,16€
Globo led	G120	E27 18W	1700Lm	4200K	BLED-085	20,16€
Globo led	G120	E27 18W	1700Lm	5000K	BLED-086	20,16€

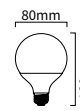

Reflectora E14



NEW PRICE!!

				°K	Ref	PVPR
Reflectora R50	R50	E14 5W	400Lm	3200K	BLED-093	5,28€
Reflectora R50	R50	E14 5W	400Lm	4200K	BLED-131	5,28€
Reflectora R50	R50	E14 5W	400Lm	5000K	BLED-097	5,28€

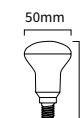

Reflectora E27



NEW PRICE!!

				°K	Ref	PVPR
Reflectora R63	R63	E27 8W	720Lm	3200K	BLED-094	5,73€
Reflectora R63	R63	E27 8W	720Lm	4200K	BLED-132	5,73€
Reflectora R63	R63	E27 8W	720Lm	5000K	BLED-098	5,73€
Reflectora R80	R80	E27 10W	950Lm	3200K	BLED-095	6,33€
Reflectora R80	R80	E27 10W	950Lm	4200K	BLED-133	6,33€
Reflectora R80	R80	E27 10W	950Lm	5000K	BLED-116	6,33€
Reflectora R90	R90	E27 12W	1000Lm	3200K	BLED-096	6,90€
Reflectora R90	R90	E27 12W	1000Lm	4200K	BLED-134	6,90€
Reflectora R90	R90	E27 12W	1000Lm	5000K	BLED-099	6,90€

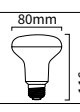
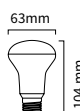

Lámpara T7



				°K	Ref	PVPR
Lámpara T7	T7	E14 9W	750Lm	3200K	BLED-141	6,99€
Lámpara T7	T7	E14 9W	750Lm	4200K	BLED-142	6,99€
Lámpara T7	T7	E14 9W	750Lm	5000K	BLED-143	6,99€
Lámpara T7	T7	E27 9W	750Lm	3200K	BLED-144	6,99€
Lámpara T7	T7	E27 9W	750Lm	4200K	BLED-145	6,99€
Lámpara T7	T7	E27 9W	750Lm	5000K	BLED-146	6,99€

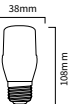

* Según la nueva normativa ERP ha habido un cambio en la medición de Lúmenes y vatios, pero sigue emitiendo la misma cantidad de luz.

A medida que vayan entrando los nuevos modelos con ERP se irá actualizando en catálogo y cajas de color.

Puede haber variación respecto a la caja del producto (comprobar en ficha técnica), todos los datos en catálogo están correctos salvo error tipográfico.

Reflectora 3CCT

3 en 1 TRES TIPOS DE LUZ
EN LA MISMA LUMINARIA

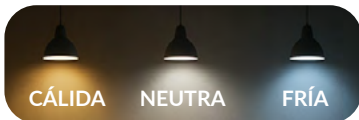

Switch
3CCT



SWITCH 5CCT
INTERRUPTOR

	°K	Ref	PVPR
REFLECTORA R90 12W	E27 3CCT	BLED-274	7,74€

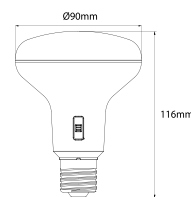

PAR 30



			°K	Ref	PVPR
PAR30		<i>E27 10w 800lm</i>	3200K	BLED-118	13,74€
PAR30		<i>E27 10w 800lm</i>	4200K	BLED-119	13,74€
PAR30		<i>E27 10w 800lm</i>	5000K	BLED-120	13,74€

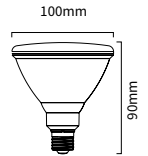

			°K	Ref	PVPR
PAR30	BLANCO	<i>E27 20w 1900lm</i>	3200K	BLED-249	32,34€
PAR30	BLANCO	<i>E27 20w 1900lm</i>	4200K	BLED-250	32,34€
PAR30	BLANCO	<i>E27 20w 1900lm</i>	5000K	BLED-251	32,34€

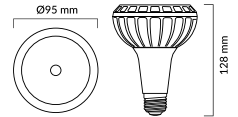

PAR30	NEGRO	<i>E27 20w 1900lm</i>	3200K	BLED-252	32,34€
PAR30	NEGRO	<i>E27 20w 1900lm</i>	4200K	BLED-253	32,34€
PAR30	NEGRO	<i>E27 20w 1900lm</i>	5000K	BLED-254	32,34€

Ensamblado
CREE
LED Chips



			°K	Ref	PVPR
PAR30	BLANCO	<i>E27 28w 2600lm</i>	3200K	BLED-110	62,97€
PAR30	BLANCO	<i>E27 28w 2600lm</i>	4200K	BLED-111	62,97€
PAR30	BLANCO	<i>E27 28w 2600lm</i>	5000K	BLED-112	62,97€
PAR30	NEGRO	<i>E27 28w 2600lm</i>	3200K	BLED-138	62,97€
PAR30	NEGRO	<i>E27 28w 2600lm</i>	4200K	BLED-139	62,97€
PAR30	NEGRO	<i>E27 28w 2600lm</i>	5000K	BLED-140	62,97€

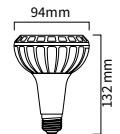

ALTA
LUMINOSIDAD

			K°	Ref	PVPR
PAR30	BLANCO	<i>E27 30w 2600lm</i>	3200K	BLED-416	34,62€
PAR30	BLANCO	<i>E27 30w 2600lm</i>	4200K	BLED-420	34,62€

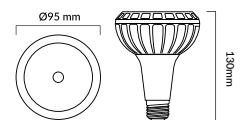

ALTA
LUMINOSIDAD

			K°	Ref	PVPR
PAR30	NEGRO	<i>E27 30w 2600lm</i>	3200K	BLED-421	34,62€
PAR30	NEGRO	<i>E27 30w 2600lm</i>	4200K	BLED-422	34,62€

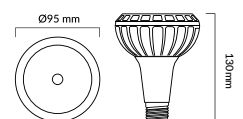

PAR38 E27

5 en 1 CINCO TIPOS DE LUZ EN LA MISMA LUMINARIA

NEW!

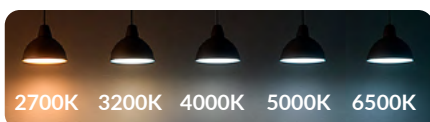

PAR38 E27 15W E27 5CCT BLED-272 15,60€



Compatible con picas de jardin

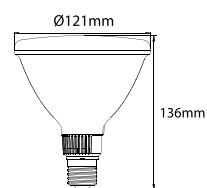

3 en 1 TRES TIPOS DE LUZ EN LA MISMA LUMINARIA

NEW!

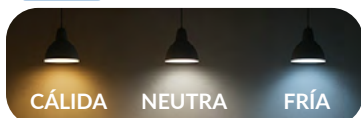

PAR38 E27 15W 1400lm 3CCT BLED-117 22,83€



Compatible con picas de jardin

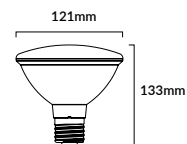

PAR 38 Monocolor



Monocolor			K°	Ref	PVPR
PAR38	BLANCO	E27 15w 200lm	3200K	BLED-121	20,91€
PAR38	BLANCO	E27 15w 200lm	4200K	BLED-122	20,91€
PAR38	BLANCO	E27 15w 200lm	5000K	BLED-123	20,91€
PAR38	NEGRO	E27 15w 200lm	3200K	BLED-124	20,91€
PAR38	NEGRO	E27 15w 200lm	5000K	BLED-125	20,91€

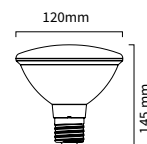

NEW PRICE!!



Colores independientes

PAR38	BLACK BODY	E27 15w 200lm	VERDE	BLED-126	18,06€
PAR38	BLACK BODY	E27 15w 200lm	AZUL	BLED-127	20,91€
PAR38	BLACK BODY	E27 15w 200lm	ROJO	BLED-128	20,91€

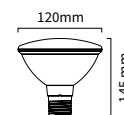

Serie QR111

NEW PRICE!!



			°K	Ref	PVPR
QR111 LED SMD	20	GUI0 12W	1100Lm 2700K	QR-026	23,85€
QR111 LED SMD	20	GUI0 12W	1100Lm 3200K	QR-017	18,45€
QR111 LED SMD	20	GUI0 12W	1100Lm 4200K	QR-018	18,45€
QR111 LED SMD	20	GUI0 12W	1100Lm 5000K	QR-019	18,45€
QR111 LED SMD DIMMABLE TRIAC	50	GUI0 12W	1100Lm 3200K	QR-024	35,94€
QR111 LED SMD DIMMABLE TRIAC	50	GUI0 12W	1100Lm 4200K	QR-023	35,94€
QR111 LED SMD DIMMABLE TRIAC	50	GUI0 12W	1100Lm 5000K	QR-025	35,94€

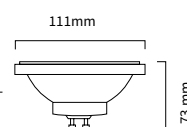

QR-024/023/025
SOLO REGULACIÓN TRIAC
pág.37

NEW!



			°K	Ref	PVPR
QR111 LED SMD		GUI0 18W	1700Lm 3200K	QR-027	22,44€
QR111 LED SMD		GUI0 18W	1700Lm 4200K	QR-028	22,44€

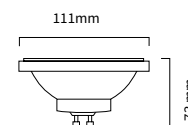

Used SAMSUNG LED Chips



			°K	Ref	PVPR
MÓDULO QR111 LED COB		30W 3000Lm	3200K	QR-014	75,84€
MÓDULO QR111 LED COB		30W 3000Lm	4200K	QR-015	75,84€
MÓDULO QR111 LED COB		30W 3000Lm	5000K	QR-016	75,84€

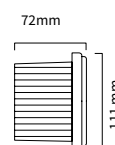

NEW PRICE!!



			°K	Ref	PVPR
QR111 LED SMD 12V		G53 12W	1000Lm 3200K	QR-020	21,69
QR111 LED SMD 12V		G53 12W	1000Lm 4200K	QR-021	21,69
QR111 LED SMD 12V		G53 12W	1000Lm 5000K	QR-022	21,69

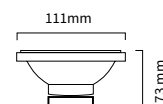

Sólo disponible para instalaciones de QR111 y Dicroica 12v

			Ref	PVPR
Alimentador Meanwell	LRS-100-12	100W	ALM-026	63,81€
Alimentador Meanwell	LRS-100-12	200W	ALM-027	133,08€
Alimentador Meanwell	LRS-100-12	350W	ALM-028	157,83€



* Según la nueva normativa ERP ha habido un cambio en la medición de Lúmenes y vatios, pero sigue emitiendo la misma cantidad de luz.

A medida que vayan entrando los nuevos modelos con ERP se irá actualizando en catálogo y cajas de color.

Puede haber variación respecto a la caja del producto (comprobar en ficha técnica), todos los datos en catálogo están correctos salvo error tipográfico.

Serie Dicroicas

ALTA CALIDAD - ALTO RENDIMIENTO

Dicroica led con batería integrada.



NEW!

1h de autonomía

Batería Li-ion
500mAh

Lm emergencia
60Lm

DICROICA CON BATERÍA 5W GU10 60°

K	Ref	PVPR
4200K	DIC-110	13,56€



Consultar instrucciones en ficha técnica para características de uso



Batería integrada
alta duración
500mAh

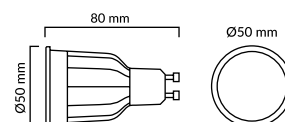

Dicroicas GU10

Used SAMSUNG LED Chips



Dicroica LED SAMSUNG	GUI0 6W 480Lm	2700K	DIC-086	3,21€
Dicroica LED SAMSUNG	GUI0 6W 510Lm	3200K	DIC-087	3,21€
Dicroica LED SAMSUNG	GUI0 6W 510Lm	4200K	DIC-088	3,21€
Dicroica LED SAMSUNG	GUI0 6W 510Lm	5000K	DIC-089	3,21€

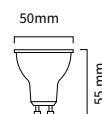

Used SAMSUNG LED Chips



Dicroica LED SAMSUNG	GUI0 6W 540Lm	3200K	DIC-091	3,21€
Dicroica LED SAMSUNG	GUI0 6W 540Lm	4200K	DIC-092	3,21€
Dicroica LED SAMSUNG	GUI0 6W 540Lm	5000K	DIC-093	3,21€

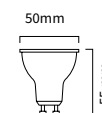

Dicroica LED SMD	GUI0 6,5W 590Lm	3200K	DIC-068	4,86€
Dicroica LED SMD	GUI0 6,5W 590Lm	4200K	DIC-069	4,86€
Dicroica LED SMD	GUI0 6,5W 590Lm	5000K	DIC-070	4,86€

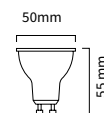



Dicroica LED SMD	GUI0 8W 700Lm	2700K	DIC-083	6,15€
Dicroica LED SMD	GUI0 8W 700Lm	3200K	DIC-071	6,15€
Dicroica LED SMD	GUI0 8W 700Lm	4200K	DIC-072	6,15€
Dicroica LED SMD	GUI0 8W 700Lm	5000K	DIC-073	6,15€
Dicroica LED SMD DIMMABLE TRIAC	GUI0 8W 700Lm	2700K	DIC-104	9,96€
Dicroica LED SMD DIMMABLE TRIAC	GUI0 8W 700Lm	3200K	DIC-081	9,96€
Dicroica LED SMD DIMMABLE TRIAC	GUI0 8W 700Lm	4200K	DIC-064	9,96€
Dicroica LED SMD DIMMABLE TRIAC	GUI0 8W 700Lm	5000K	DIC-082	9,96€

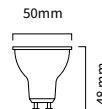
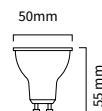

DIC-081/064/082
SOLO REGULACIÓN TRIAC
 pág.37



Dicroica LED SMD	GUI0 9W 920Lm	3200K	DIC-061	10,44€
Dicroica LED SMD	GUI0 9W 920Lm	4200K	DIC-062	10,44€
Dicroica LED SMD	GUI0 9W 920Lm	5000K	DIC-063	10,44€

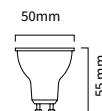

Dicroica LED SMD	GUI0 9W 1100Lm	3200K	DIC-066	14,40€
Dicroica LED SMD	GUI0 9W 1100Lm	4200K	DIC-077	14,40€
Dicroica LED SMD	GUI0 9W 1100Lm	5000K	DIC-067	14,40€
Dicroica LED SMD DIMMABLE TRIAC	GUI0 9W 1100Lm	3200K	DIC-084	17,91€
Dicroica LED SMD DIMMABLE TRIAC	GUI0 9W 1100Lm	4200K	DIC-065	17,91€
Dicroica LED SMD DIMMABLE TRIAC	GUI0 9W 1100Lm	5000K	DIC-085	17,91€

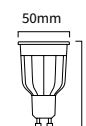

DIC-084/065/085
SOLO REGULACIÓN TRIAC
 pág.37



		°K	Ref	PVPR
Dicroica LED SMD 12V	MR16 8W 590Lm	3200K	DIC-074	7,05€
Dicroica LED SMD 12V	MR16 8W 590Lm	4200K	DIC-075	7,05€
Dicroica LED SMD 12V	MR16 8W 590Lm	5000K	DIC-076	7,05€

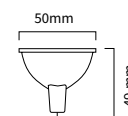

Sólo disponible para instalaciones de QR111 y Dicroica 12v

		Ref	PVPR
Alimentador Meanwell	LRS-100-12 100W	ALM-026	63,81€
Alimentador Meanwell	LRS-100-12 200W	ALM-027	133,08€
Alimentador Meanwell	LRS-100-12 350W	ALM-028	157,83€



Módulo Dicroica

Usar **CREE** LED Chips



		°K	Ref	PVPR
Módulo 15w Dicroica	15W 1500Lm	3200K	DIC-078	54,00€
Módulo 15w Dicroica	15W 1500Lm	5000K	DIC-080	54,00€

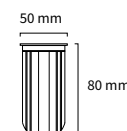

Portalamparas



Portalámparas cerámico	GUI0	PORTLM-002	0,66€
------------------------	------	------------	-------

- Módulo 3CCT
- Dicroicas 3CCT

Módulo Dicroica 3CCT



3 en 1 TRES TIPOS DE LUZ EN LA MISMA LUMINARIA

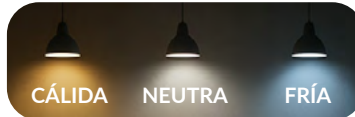

Switch 3CCT



MÓDULO LED 3CCT

Blanco 3CCT

Ref

PVPR

DIC-097

7,80€



3200K / 4200K / 5000K

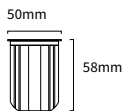

Dicroica 3CCT



DICROICA LED 7W GU10 3CCT 60°

3CCT

Ref

PVPR

DIC-094

3,96€



3200K / 4200K / 5000K

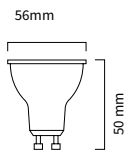

Ángulo 60°



DICROICA LED 7W GU10 3CCT 15°

3CCT

Ref

PVPR

DIC-099

4,14€



2700K / 3200K / 4200K

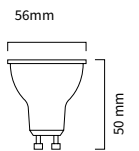

3 en 1 TRES TIPOS DE LUZ EN LA MISMA LUMINARIA

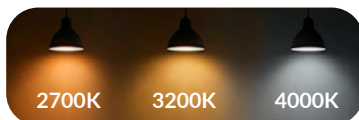

Ángulo 15°



Serie módulo Techos bajos

Mini light 3CCT



INSTALACIÓN DIRECTA POR PRESIÓN
NO NECESITA ARO

AROS PARA DIC-096
INTERCAMBIABLES
INCLUIDOS



AROS PARA DIC-098
INTERCAMBIABLES
INCLUIDOS



Corte
Ø35mm

DICROICA ESPECIAL **TECHOS BAJOS**

Ref PVPR

MINILIGHT LED COMPACTA CON CABLE REDONDO	3CCT	DIC-096	3,93€
MINILIGHT LED COMPACTA CON CABLE CUADRADO	3CCT	DIC-098	3,93€



2700K / 3200K / 4200K

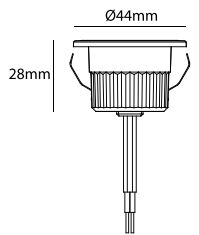

Dicrocia 3CCT



DICROICA ESPECIAL **TECHOS BAJOS**

Ref PVPR

DICROICA LED COMPACTA CON CABLE	3CCT	DIC-095	6,48€
---------------------------------	------	---------	-------



3200K / 4200K / 5000K

DICROICA ESPECIAL **TECHOS BAJOS**

K Ref PVPR

DICROICA LED COMPACTA CON CABLE DIMMABLE	2700K	DIC-100	7,98€
DICROICA LED COMPACTA CON CABLE DIMMABLE	3200K	DIC-101	7,98€
DICROICA LED COMPACTA CON CABLE DIMMABLE	4200K	DIC-102	7,98€



SOLO REGULACIÓN TRIAC
pág.37

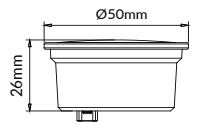

Ideal para espacios reducidos

donde no caben bombillas GU10



Cable conexión 10cm

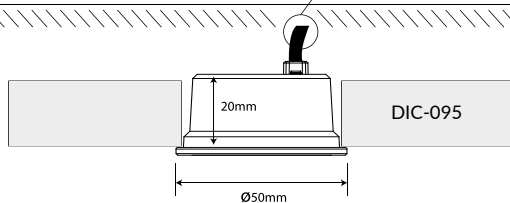

Ejemplo de instalación con ARO-053

* Según la nueva normativa ERP ha habido un cambio en la medición de Lúmenes y vatios, pero sigue emitiendo la misma cantidad de luz.

A medida que vayan entrando los nuevos modelos con ERP se irá actualizando en catálogo y cajas de color.

Puede haber variación respecto a la caja del producto (comprobar en ficha técnica), todos los datos en catálogo están correctos salvo error tipográfico.



SERIE MINILIGHT



ALUMINIO



REAL COLOR SERIES



Alta fidelidad en la
reproducción de los
colores

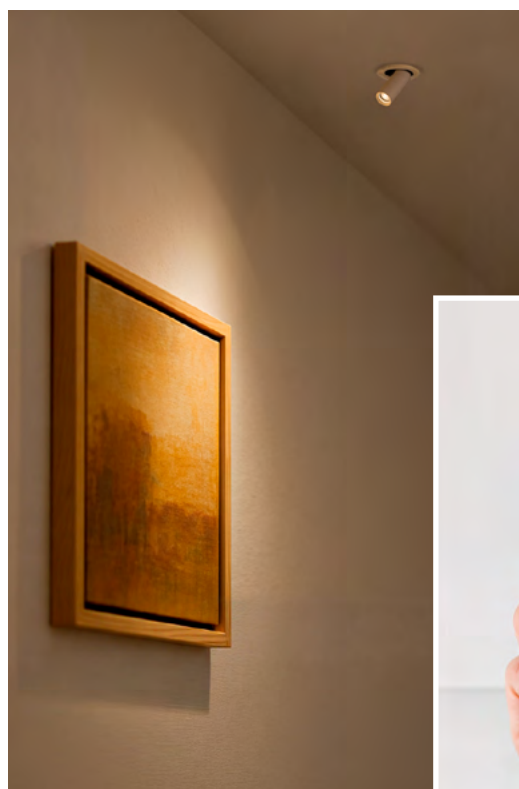

Ventajas CRI90

- **Colores más reales y vivos**
Reproduce los colores de forma más natural, como se verían bajo luz solar.
Ideal para entornos donde la percepción del color es clave.
- **Mayor confort visual**
Reduce la fatiga ocular y mejor la percepción general del entorno.
- **Mejora en presentación de productos**
Los productos se ven más atractivos y fieles a su color original, aumentando las ventas.
- **Recomendado para normativas profesionales**
En sectores como sanidad, arte, hostelería o cosmética se exige o recomienda un CRI alto.

SERIE MINILIGHT



40.000 HORAS DE VIDA



LARGA VIDA UTIL



5 AÑOS GARANTÍA



NEW!

ALUMINIO



Driver EAGLERISE

			Ref	PVPR
MINILIGHT CIRCULAR 4W	Blanco	3CCT	DOW-385	20,55€
MINILIGHT CIRCULAR 4W	Negro	3CCT	DOW-386	20,55€



Corte Ø35mm

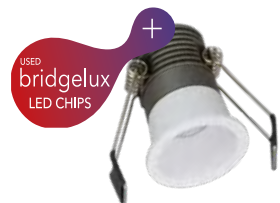
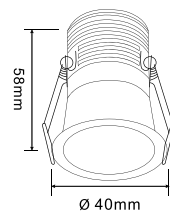

USED bridgelux LED CHIPS

— ACCESORIOS — (No incluido) —

LENTE INTERCAMBIABLE 24°

ACLED-262- 24°

CONTR-383 - DRIVER REGULABLE

3 en 1 TRES TIPOS DE LUZ EN LA MISMA LUMINARIA

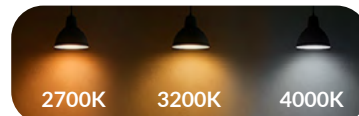

NEW!

ALUMINIO



Driver EAGLERISE

			Ref	PVPR
MINILIGHT CIRCULAR ORIENTABLE 5W	Blanco	3CCT	DOW-383	29,40€
MINILIGHT CIRCULAR ORIENTABLE 5W	Negro	3CCT	DOW-384	29,40€



Corte Ø45mm

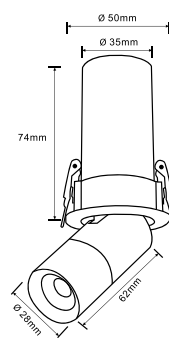

USED bridgelux LED CHIPS

— ACCESORIOS — (No incluido) —

LENTE INTERCAMBIABLE 15° - 24°

ACLED-260 - 15° / ACLED-261 - 24°

CONTR-383 - DRIVER REGULABLE

3 en 1 TRES TIPOS DE LUZ EN LA MISMA LUMINARIA

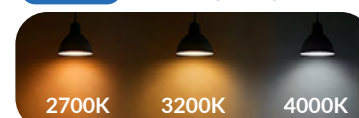

* Según la nueva normativa ERP ha habido un cambio en la medición de Lúmenes y vatios, pero sigue emitiendo la misma cantidad de luz. A medida que vayan entrando los nuevos modelos con ERP se irá actualizando en catálogo y cajas de color. Puede haber variación respecto la caja del producto (comprobar en ficha técnica), todos los datos en catálogo están correctos salvo error tipográfico.

Serie Aro Led Integrado



LED CHIP
ALTA CALIDAD

UGR<19

3 en 1 TRES TIPOS DE LUZ
EN LA MISMA LUMINARIA

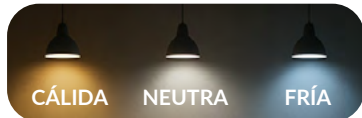

Switch
3CCT



DISPONIBLE MÓDULO
LED DE SUSTITUCIÓN



○ FORMA
CIRCULAR

* LED INTEGRADO



					K°	Ref	PVPR
DOWNLIGHT MINI	CIRCULAR RECTO	Blanco	8w	3CCT	DOW-324	11,52€	
DOWNLIGHT MINI	CIRCULAR RECTO	Negro	8w	3CCT	DOW-325	11,52€	

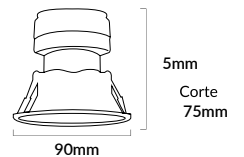

DOWNLIGHT MINI	CIRCULAR ASIMÉTRICO	Blanco	8w	3CCT	DOW-326	11,52€
DOWNLIGHT MINI	CIRCULAR ASIMÉTRICO	Negro	8w	3CCT	DOW-327	11,52€

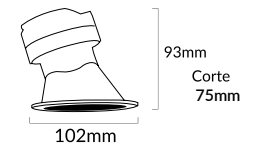

□ FORMA
CUADRADO

* LED INTEGRADO



DOWNLIGHT MINI	CUADRADO RECTO	Blanco	8w	3CCT	DOW-328	11,52€
DOWNLIGHT MINI	CUADRADO RECTO	Negro	8w	3CCT	DOW-329	11,52€

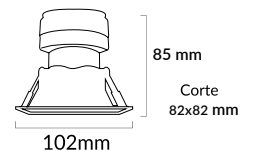

DOWNLIGHT MINI	CUADRADO ASIMÉTRICO	Blanco	8w	3CCT	DOW-330	11,52€
DOWNLIGHT MINI	CUADRADO ASIMÉTRICO	Negro	8w	3CCT	DOW-331	11,52€

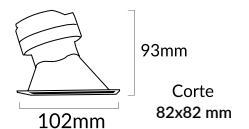



Serie Aro Led Integrado

LED CHIP
ALTA CALIDAD

* LED INTEGRADO



					K°	Ref	PVPR
DOWNLIGHT MINI	CIRCULAR ORIENTABLE 360°	Blanco	7w		3200K	DOW-342	8,55€
DOWNLIGHT MINI	CIRCULAR ORIENTABLE 360°	Blanco	7w		4200K	DOW-343	8,55€
DOWNLIGHT MINI	CIRCULAR ORIENTABLE 360°	Blanco	7w		5000K	DOW-344	8,55€

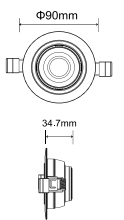

* LED INTEGRADO



					K°	Ref	PVPR
DOWNLIGHT MINI	CUADRADO ORIENTABLE 360°	Blanco	7w		3200K	DOW-345	8,70€
DOWNLIGHT MINI	CUADRADO ORIENTABLE 360°	Blanco	7w		4200K	DOW-346	8,70€
DOWNLIGHT MINI	CUADRADO ORIENTABLE 360°	Blanco	7w		5000K	DOW-347	8,70€

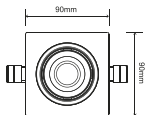

Serie G9 y lineales



Para Downlights - CASQUILLO ROTATORIO

				°K		Ref	PVPR
Lámpara PL	G24 2PIN 9W	800Lm		3200K	☀	BLED-147	14,25€
Lámpara PL	G24 2PIN 9W	800Lm		4200K	☁	BLED-136	12,30€
Lámpara PL	G24 2PIN 9W	800Lm		5000K	🌈	BLED-137	12,30€

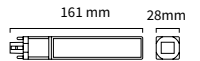

				°K		Ref	PVPR	
Lámpara Mini	12V	100	G4 1.2W	100Lm	3200K	☀	BLED-360	4,14€
Lámpara Mini	12V	100	G4 1.2W	100Lm	5000K	🌈	BLED-361	4,14€

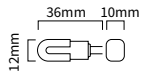

				°K		Ref	PVPR
Lámpara	12V	G4 2W	200Lm	3200K	☀	BLED-199	4,47€
Lámpara	12V	G4 2W	200Lm	4200K	☁	BLED-200	4,47€
Lámpara	12V	G4 2W	200Lm	5000K	🌈	BLED-201	4,47€
Lámpara	230V	G9 3W	300Lm	3200K	☀	BLED-193	2,49€
Lámpara	230V	G9 3W	300Lm	4200K	☁	BLED-194	2,49€
Lámpara	230V	G9 3W	300Lm	5000K	🌈	BLED-195	2,49€
Lámpara	230V	G9 4W	380Lm	4200K	☁	BLED-197	3,09€
Lámpara	230V	G9 4W	380Lm	5000K	🌈	BLED-198	3,09€

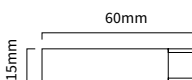
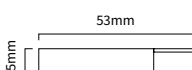
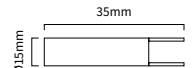

				°K		Ref	PVPR
Lámpara LED Mini	G9 2,5W	220Lm		3200K	☀	BLED-356	4,92€
Lámpara LED Mini	G9 2,5W	220Lm		5000K	🌈	BLED-357	4,92€
Lámpara LED Mini	G9 3W	300Lm		3200K	☀	BLED-358	6,06€
Lámpara LED Mini	G9 3W	300Lm		5000K	🌈	BLED-359	6,06€

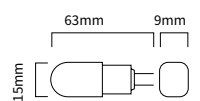
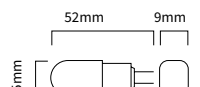



			°K	Ref	PVPR
Lámpara LED Mini DIMMABLE TRIAC	G9 3.5w	370lm	4200K	BLED-202	9,06€
Lámpara LED Mini DIMMABLE TRIAC	G9 3.5w	370lm	5000K	BLED-072	9,06€



SOLO REGULACIÓN TRIAC

pág.35

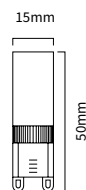

Lámpara LED SAMSUNG DIMMABLE TRIAC	G9 4w	450lm	3200K	BLED-435	8,94€
------------------------------------	-------	-------	-------	----------	-------



SOLO REGULACIÓN TRIAC

pág.35

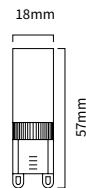

			°K	Ref	PVPR
Lámpara LED COB	G9 4w	400lm	3200K	BLED-229	7,17€
Lámpara LED COB	G9 4w	400lm	4200K	BLED-230	7,17€
Lámpara LED COB	G9 4w	400lm	5000K	BLED-231	7,17€



			°K	Ref	PVPR
Lámpara LED Alta luminosidad	G9 4.5w	530lm	3200K	BLED-246	5,61€
Lámpara LED Alta luminosidad	G9 4.5w	530lm	4200K	BLED-247	5,61€
Lámpara LED Alta luminosidad	G9 4.5w	530lm	5000K	BLED-248	5,61€



				°K	Ref	PVPR
Lineal Slim Led	78mm R7S 5w	450lm	3200K	LIN-013	13,74€	
Lineal Slim Led	78mm R7S 5w	450lm	4200K	LIN-014	13,74€	
Lineal Slim Led	78mm R7S 5w	450lm	5000K	LIN-015	13,74€	
Lineal Slim Led	118mm R7S 8w	800lm	3200K	LIN-016	15,54€	
Lineal Slim Led	118mm R7S 8w	800lm	4200K	LIN-017	15,54€	
Lineal Slim Led	118mm R7S 8w	800lm	5000K	LIN-018	15,54€	

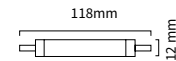
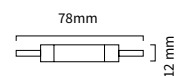

				°K	Ref	PVPR
Lineal Led DIMMABLE TRIAC	78mm R7S 10w	1100lm	3200K	LIN-019	23,37€	
Lineal Led DIMMABLE TRIAC	78mm R7S 10w	1100lm	4200K	LIN-020	23,37€	
Lineal Led DIMMABLE TRIAC	78mm R7S 10w	1100lm	5000K	LIN-021	23,37€	
Lineal Slim Led DIMMABLE TRIAC	118mm R7S 14w	2000lm	3200K	LIN-022	26,55€	
Lineal Slim Led DIMMABLE TRIAC	118mm R7S 14w	2000lm	4200K	LIN-023	26,55€	
Lineal Slim Led DIMMABLE TRIAC	118mm R7S 14w	2000lm	5000K	LIN-024	26,55€	



SOLO REGULACIÓN TRIAC

pág.37

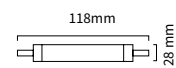
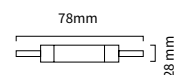

				°K	Ref	PVPR
Lineal Slim Led COB	78mm R7S 6w	500lm	3200K	LIN-025	12,66€	
Lineal Slim Led COB	78mm R7S 6w	500lm	4200K	LIN-026	12,66€	
Lineal Slim Led COB	78mm R7S 6w	500lm	5000K	LIN-027	12,66€	
Lineal Slim Led COB	118mm R7S 10w	1300lm	3200K	LIN-028	16,26€	
Lineal Slim Led COB	118mm R7S 10w	1300lm	4200K	LIN-029	16,26€	
Lineal Slim Led COB	118mm R7S 10w	1300lm	5000K	LIN-030	16,26€	

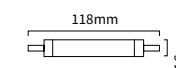
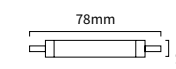

* Según la nueva normativa ERP ha habido un cambio en la medición de Lúmenes y vatios, pero sigue emitiendo la misma cantidad de luz.

A medida que vayan entrando los nuevos modelos con ERP se irá actualizando en catálogo y cajas de color.

Puede haber variación respecto a la caja del producto (comprobar en ficha técnica), todos los datos en catálogo están correctos salvo error tipográfico.

Serie lámparas domóticas

COMPATIBLE
CON APP
tuya



3 en 1 TRES TIPOS DE LUZ
EN LA MISMA LUMINARIA

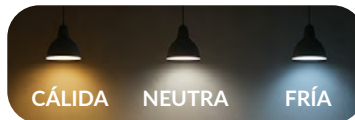

	°K	Ref	PVPR
Dicroica Led WiFi DIMMABLE 🌙 GU10 5W 400Lm 📶 🌈 ⬇️		DIC-090	21,51€

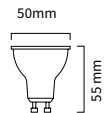

	°K	Ref	PVPR
Miniesférica Led WiFi DIMMABLE 🌙 G45 E14 5W 470Lm 📶 🌈 ⬇️		BLED-221	21,51€
Miniesférica Led WiFi DIMMABLE 🌙 G45 E27 5W 470Lm 📶 🌈 ⬇️		BLED-220	21,51€

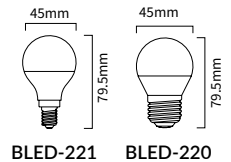

	°K	Ref	PVPR
Standar Led WiFi DIMMABLE 🌙 A60 E27 10W 900Lm 📶 🌈 ⬇️		BLED-219	21,51€

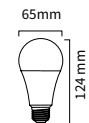

	°K	Ref	PVPR
Globo Led WiFi DIMMABLE 🌙 G95 E27 11W 1055Lm 📶 🌈 ⬇️		BLED-222	28,71€
Globo Led WiFi DIMMABLE 🌙 G120 E27 15W 1520Lm 📶 🌈 ⬇️		BLED-223	32,31€

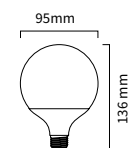



Para interruptor simple, conmutado y cruce



PASTILLA INTERRUPTOR MINI LED

WiFi 300W LED



Ref

PVPR

CONTR-054

41,91€

tuya

230 V -



No apta para instalaciones conmutables

PASTILLA INTERRUPTOR MINI MULTIFUNCIÓN

WiFi 300W LED



CONTR-082

29,85€

tuya

230 V -



Para DOBLE interruptor, interruptor partido y conmutado

PASTILLA DOBLE INTERRUPTOR LED

WiFi 2 X 150W



CONTR-042

56,31€

tuya

230 V -

Disponibles para varios pulsadores



Para varios pulsadores **REGULACIÓN TRIAC**



PASTILLA DIMMABLE TRIAC

WiFi 300W LED

WiFi 300W LED



CONTR-063

60,66€

tuya

230 V -



PASTILLA TELERRUPTOR MINI WiFi 16A 230V - 300W LED



CONTR-071

45,06€

tuya

230 V -

NEW!



REGULACIÓN TRIAC DIMMABLE 0-100% SIN PARPADEO



CONTROLADOR DIMMABLE TRIAC WiFi PULSADOR



CONTR-096

84,30€

tuya

230 V -

· CONEXIÓN WiFi, 2,4Ghz, BLUETOOTH / CONTROL REMOTO 2,4Ghz



NEW!



PASTILLA DIMMABLE TRIAC WiFi RF UART HOLE

200W



Ref

PVPR

CONTR-104

58,50€

tuya

230 V -



Accesorio control remoto pulsador dimmable
CONTR-105 (No incluido)

CONTR-105

20,37€

NO DISPONE DE WiFi



PASTILLA PULSADOR CON EFECTO MEMORIA - FUNCIONA PARA VARIOS PULSADORES - NO DISPONE DE WiFi

PASTILLA DIMMABLE TRIAC POR PULSADOR



MÁX 360W



CONTR-022

52,62€

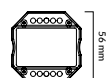
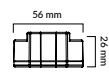

CONTR-036 CONTR-098

COMPATIBLE CON MANDO CONTR-036 Y CONTR-098

REGULACIÓN TRIAC



PASTILLA DIMMABLE TRIAC LED SIN NEUTRO MÁX 250W



CONTR-083

55,02€

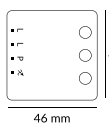

Este dimmer LED está diseñado para el control de lámparas LED regulables de hasta 250W. Con características de diseño compacto, brillo ajustable, potencia y memoria de ajuste de luz, es fácil de instalar y operar.

- Tamaño compacto
- Sin ruido
- Regulación del borde de salida
- No necesita línea neutra
- Ideal para reequipamiento
- Luminosidad y velocidad de regulación regulables
- Memoria de potencia y luminosidad

REGULACIÓN TRIAC



- REGULACIÓN TRIAC
- NO DISPONE DE WiFi
- NO APTA PARA INSTALACIONES CONMUTADAS
- SE PUEDE USAR CON PULSADORES EN PARALELO



Serie Aros



Serie Aros GU10 - Aluminio

PARA
DICROICA GU10



-Para Dicroicas GU10-MR16 - Aluminio - Lámpara no incluida - Incluye portalámparas

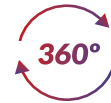

BASCULANTE
EN UNA ÚNICA
ORIENTACIÓN

ARO AXIS REDONDO BASCULANTE



ALUMINIO

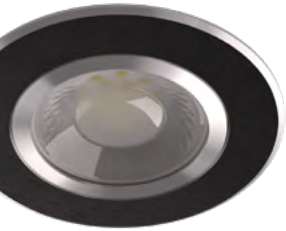

Negro ARO-019 8,13€



Aluminio brushed ARO-018 8,13€



Blanco mate ARO-017 8,13€

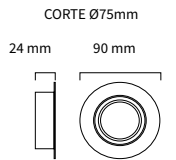

ARO AXIS CUADRADO BASCULANTE

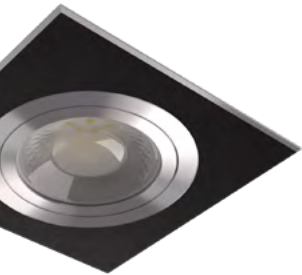

Negro ARO-022 8,49€

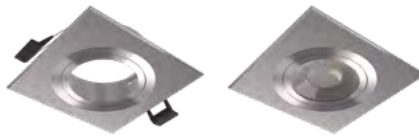

Aluminio brushed ARO-021 8,49€

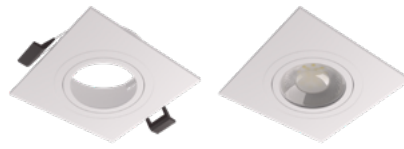

Blanco mate ARO-020 8,49€

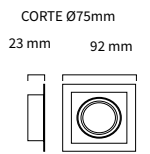

ARO AXIS CUADRADO DOBLE BASCULANTE

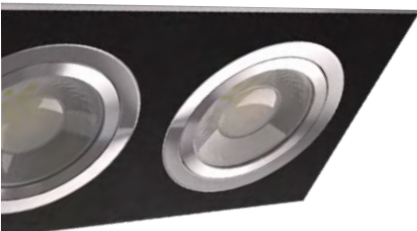

Negro ARO-025 16,02€



Aluminio brushed ARO-024 16,02€



Blanco mate ARO-023 16,02€

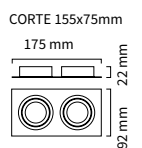

* Según la nueva normativa ERP ha habido un cambio en la medición de Lúmenes y vatios, pero sigue emitiendo la misma cantidad de luz. A medida que vayan entrando los nuevos modelos con ERP se irá actualizando en catálogo y cajas de color. Puede haber variación respecto a la caja del producto (comprobar en ficha técnica), todos los datos en catálogo están correctos salvo error tipográfico.



AROS ASIMÉTRICOS ANTIDESLUMBRANTE

-Para Dicroicas GU10-MR16 - Lámpara no incluida - No Incluye portalámparas



ALUMINIO

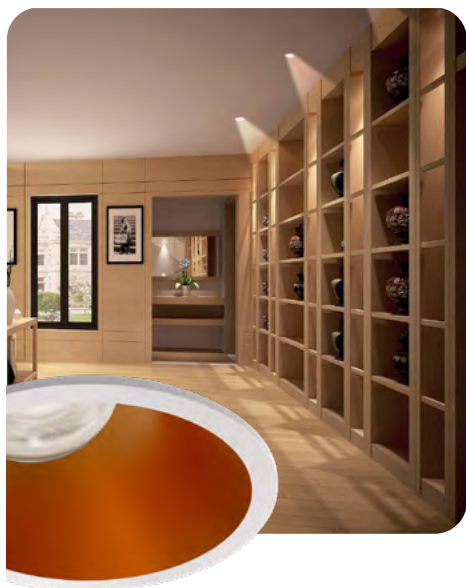

ARO AXIS D95 REDONDO 30° INCLINACIÓN



CORTE Ø89mm

60 mm 96 mm



Blanco y oro mate 12,42€
ARO-044



Blanco y negro mate 12,42€
ARO-045



Blanco 10,29€
ARO-046

ARO AXIS D95 CUADRADO 30° INCLINACIÓN



CORTE 89 x 89 mm

60 mm 96 mm

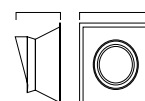

Blanco y oro mate 12,42€
ARO-047



Blanco y negro mate 12,42€
ARO-048



Blanco 10,29€
ARO-049

AROS ANTIDESLUMBRANTE

-Para Dicroicas GU10-MR16 - Lámpara no incluida - No Incluye portalámparas



ALUMINIO



ARO AXIS CIRCULAR BASCULANTE



CORTE Ø85mm

41 mm 93 mm



Negro 9,96€
ARO-042



Blanco 9,96€
ARO-013



Negro 9,06€
ARO-043



Blanco 9,06€
ARO-014

CORTE Ø84mm

50 mm 90 mm



ARO AXIS CUADRADO BASCULANTE



CORTE 81 x 81mm

41 mm 90 mm



Blanco 10,65€
ARO-015

ARO AXIS CIRCULAR BASCULANTE



35 mm 93 mm



CORTE Ø75mm



Blanco 9,06€
ARO-016

Transporte no incluido. Para más información y descarga de fichas técnicas - www.atmoss.es -

TODOS LOS PRECIOS SON EN PVPR Y ESTÁN SUJETOS A MODIFICACIONES. LOS PRECIOS ESTÁN CORRECTOS SALVO ERROR TIPOGRÁFICO, EN ÚLTIMA INSTANCIA COMPROBAR EN TARIFA DE PRECIOS - COMPROBAR MEDIDAS CON EL ARTICULO EN FÍSICO YA QUE PUEDE HABER ERROR TIPOGRÁFICO

Serie Aros Zona húmeda - Aluminio

PARA
DICROICA GU10



-Para Dicroicas GU10-MR16 - Lámpara no incluida - Incluye portalámparas

APLIQUE **ESTANCO**



ALUMINIO



Negro ARO-138 12,30€



Negro ARO-137 12,30€

IP
54



Ø85 mm

-Para Dicroicas GU10-MR16 - Lámpara no incluida - No Incluye portalámparas

APLIQUE **ESTANCO**



ALUMINIO



Negro APQ-038
10,50€



Blanco APQ-037
10,50€

IP
65

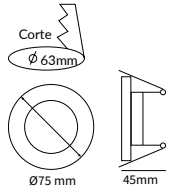

Ø75 mm

45mm



Negro APQ-042
11,61€



Blanco APQ-041
11,61€

IP
65

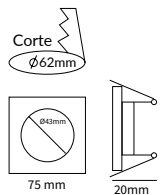

75 mm

20mm

APLIQUE **INTERIOR**



ALUMINIO



Negro APQ-040
9,93€



Blanco APQ-039
9,93€

IP
20

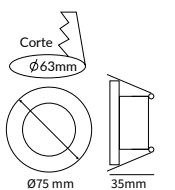

Ø75 mm

35mm

* Según la nueva normativa ERP ha habido un cambio en la medición de Lúmenes y vatios, pero sigue emitiendo la misma cantidad de luz. A medida que vayan entrando los nuevos modelos con ERP se irá actualizando en catálogo y cajas de color. Puede haber variación respecto la caja del producto (comprobar en ficha técnica), todos los datos en catálogo están correctos salvo error tipográfico.

Serie Aros GU10 - Material PC

PARA
DICROICA GU10



-Para Dicroicas GU10-MR16 - Material PC
Lámpara no incluida - Incluye portalámparas



MATERIAL PC



CAMBIO DE DICROICA SIN DESMONTAR ARO



ARO-055 / 054
051 / 050

ARO PLS-128/I CUADRADO BASCULANTE EMPOTRABLE



Negro ARO-055 4,14€



Blanco ARO-054 4,14€

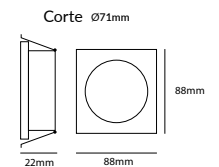

ARO PLS-119 REDONDO BASCULANTE EMPOTRABLE



Negro ARO-051 4,86€



Blanco ARO-050 4,86€

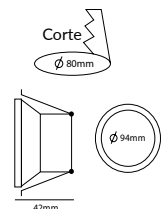

ARO PLS-123 REDONDO BASCULANTE EMPOTRABLE



Negro ARO-053 4,14€



Blanco ARO-052 4,14€

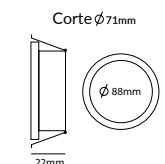

-Para Dicroicas GU10-MR16 - Material PC
Lámpara no incluida - Incluye portalámparas



MATERIAL PC

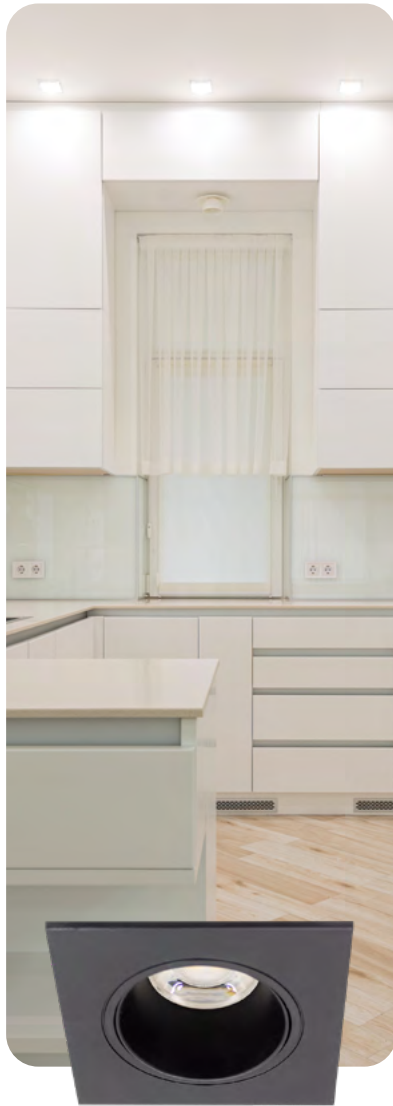

ARO PLS-90-25 CIRCULAR BASCULANTE EMPOTRABLE



Negro
ARO-070 4,74€



Blanco + Negro
ARO-069 4,74€



Blanco
ARO-068 4,74€

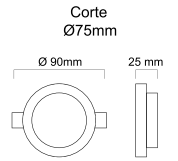

ARO PLS-90-25 CUADRADO BASCULANTE EMPOTRABLE



Negro
ARO-073 5,01€



Blanco + Negro
ARO-072 5,01€



Blanco
ARO-071 5,01€

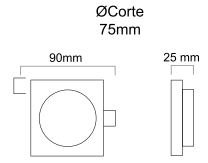

ARO PLS-172-28/2 CUADRADO BASCULANTE EMPOTRABLE



Negro
ARO-076 10,14€



Blanco + Negro
ARO-075 10,14€



Blanco
ARO-074 10,14€

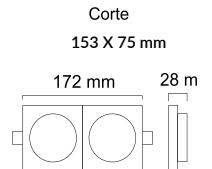

ARO PLS-255-28/3 CUADRADO BASCULANTE EMPOTRABLE



Negro
ARO-079 16,38€



Blanco + Negro
ARO-078 16,38€



Blanco
ARO-077 16,38€

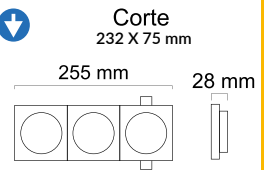

-Para Dicroicas GU10-MR16 - Material PC
Lámpara no incluida - Incluye portalámparas



MATERIAL PC

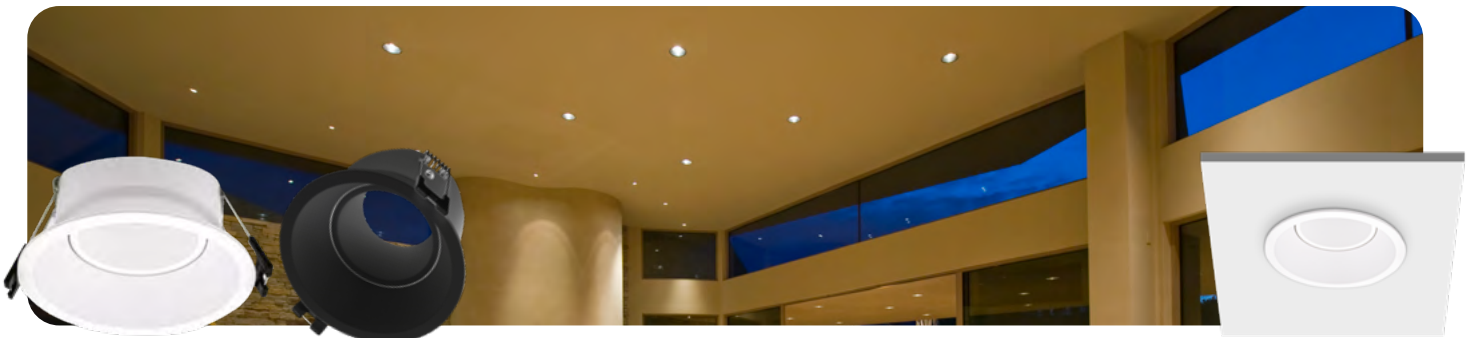

**ARO-102 - ARO PC REDONDO BASCULANTE 93x50mm
EMPOTRABLE BLANCO**

PVPR
5,19€



**ARO-103 - ARO PC REDONDO BASCULANTE 93x50mm
EMPOTRABLE NEGRO**

5,19€

Corte: Ø85mm

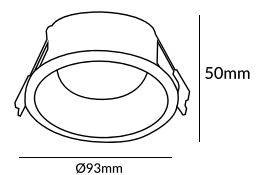

- COLOCACIÓN DE LÁMPARA POR LA PARTE TRASERA

* Según la nueva normativa ERP ha habido un cambio en la medición de Lúmenes y vatios, pero sigue emitiendo la misma cantidad de luz. A medida que vayan entrando los nuevos modelos con ERP se irá actualizando en catálogo y cajas de color. Puede haber variación respecto la caja del producto (comprobar en ficha técnica), todos los datos en catálogo están correctos salvo error tipográfico.



-Para Dicroicas GU10-MR16 - Material PC
Lámpara no incluida - Incluye portalámparas



MATERIAL PC



ARO PLS-72-103 CIRCULAR SUPERFICIE



Negro
ARO-064 8,07€



Blanco + Negro
ARO-063 8,07€



Blanco
ARO-062 8,07€

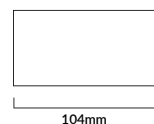

104mm

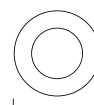

ø 75mm

ARO PLS-76-100 CUADRADO SUPERFICIE



Negro
ARO-067 9,30€



Blanco + Negro
ARO-066 9,30€



Blanco
ARO-065 9,30€

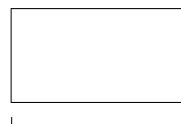

100mm

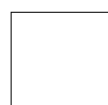

76mm

-Para Dicroicas GU10-MR16 - Material PC
Lámpara no incluida - Incluye portalámparas



MATERIAL PC

COLOR IDÉNTICO
ALUMINIO BRUSHED

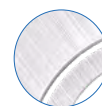

Ref

PVPR



ARO-089 - ARO PLS-85-40 CIRCULAR GU10
BASCULANTE ALUMINIO BRUSHED

4,86€

ARO-091 - ARO PLS-85-40 CUADRADO GU10
BASCULANTE ALUMINIO BRUSHED

4,86€

CORTE: Ø72mm

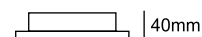

40mm

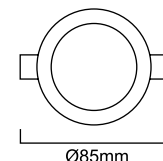

Ø85mm

ARO-088 - ARO PLS-85-40 CIRCULAR GU10
BASCULANTE PERLA MATE

3,30€

ARO-090 - ARO PLS-85-40 CUADRADO GU10
BASCULANTE PERLA MATE

3,30€

CORTE: Ø72mm

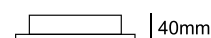

40mm

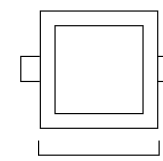
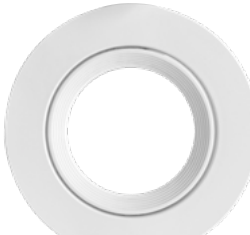

85mm

-Para Dicroicas GU10-MR16 - Material PC
Lámpara no incluida - Incluye portalámparas



MATERIAL PC



ARO ABS GU10 BASCULANTE

NEW!



Blanco
ARO-095
PVPR 5,01€



Blanco
ARO-092
PVPR 4,74€

CORTE: Ø75mm

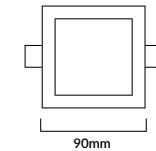
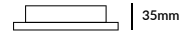

CORTE: Ø75mm

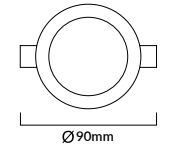
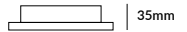

Negro
ARO-096
PVPR 5,01€



Negro
ARO-093
PVPR 4,74€

CORTE: Ø75mm

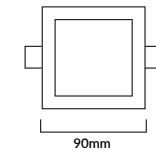
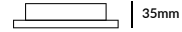

CORTE: Ø75mm

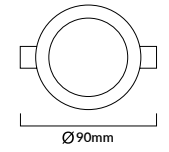

Silver
ARO-097
PVPR 5,40€



Silver
ARO-094
PVPR 5,10€

CORTE: Ø75mm

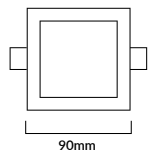
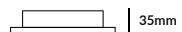

CORTE: Ø75mm

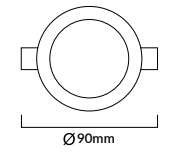
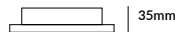

Blanco
ARO-100
PVPR 3,30€



Blanco
ARO-098
PVPR 3,15€

CORTE: 75x75mm

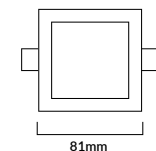
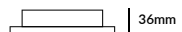

CORTE: Ø75mm

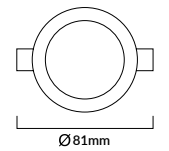
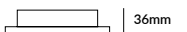

Negro
ARO-101
PVPR 3,30€



Negro
ARO-099
PVPR 3,15€

CORTE: 75x75mm

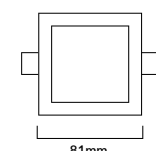
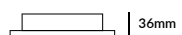

CORTE: Ø75mm

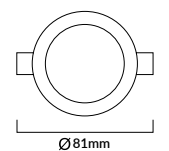

* Según la nueva normativa ERP ha habido un cambio en la medición de Lúmenes y vatios, pero sigue emitiendo la misma cantidad de luz. A medida que vayan entrando los nuevos modelos con ERP se irá actualizando en catálogo y cajas de color. Puede haber variación respecto la caja del producto (comprobar en ficha técnica), todos los datos en catálogo están correctos salvo error tipográfico.



-Para Dicroicas GU10-MR16 - Material PC
Lámpara no incluida - Incluye portalámparas



MATERIAL PC



ARO PLS-93/45 REDONDO BASCULANTE EMPOTRABLE



Negro ARO-087 4,62€



Blanco ARO-086 4,62€

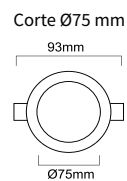

ARO PLS-93/45 CUADRADO BASCULANTE EMPOTRABLE

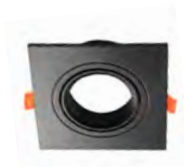

Negro ARO-081 4,74€



Blanco ARO-080 4,74€

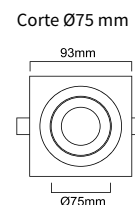

ARO PLS-173-45/2 CUADRADO BASCULANTE EMPOTRABLE



Negro
ARO-083 10,62€



Blanco
ARO-082 10,62€

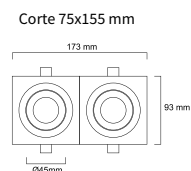

ARO PLS-255-45/3 CUADRADO BASCULANTE EMPOTRABLE



Negro
ARO-085 16,56€



Blanco
ARO-084 16,56€

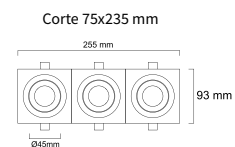

Serie Aros Zona húmeda - Material PC

PARA
DICROICA GU10



Aplique interior estanco

IP
65



-Para Dicroicas GU10-MR16 - Material PC
Lámpara no incluida - Incluye portalámparas



MATERIAL PC

PARA ZONAS HUMEDAS

NEW!



Negro
ARO-124



Blanco
ARO-125

PVPR
8,19€

CORTE: Ø73-75mm

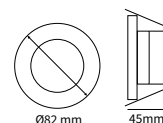

Negro
ARO-126



Blanco
ARO-127

PVPR
7,02€

CORTE: Ø75mm

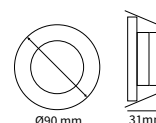

ACABADO EFECTO BRUSHED



Negro
ARO-128



Blanco
ARO-129

PVPR
7,65€

CORTE: Ø75mm

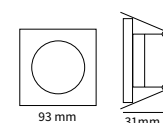

Serie Aros Especial tiendas - Aluminio

PARA
BOMBILLA QR111
Y PAR27

QR111

E27



-Para QR111 - GU10 - Aluminio
Lámpara no incluida - Incluye portalámparas

GU10

QR111



ALUMINIO

NEW!



Negro
ARO-122



Blanco
ARO-123

PVPR
25,56€



Negro
ARO-120



Blanco
ARO-121

PVPR
26,91€

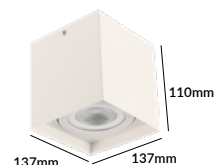

ARO BIONIQ
CIRCULAR BASCULANTE SUPERFICIE

20



QR111



ALUMINIO

Lámpara no incluida - Incluye portalámparas



Blanco
ARO-038

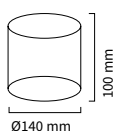

PVPR
50,10€

-Para QR111 - GU10 - Aluminio
Lámpara no incluida - Incluye portalámparas



E27



ALUMINIO

NEW!



Negro
ARO-116



Blanco
ARO-117

PVPR
25,56€



Negro
ARO-118



Blanco
ARO-119

PVPR
26,76€

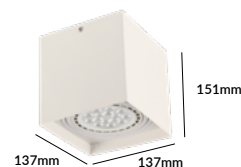

Serie Aros Especial tiendas - Aluminio

PARA
BOMBILLA QR111



ARO BIONIQ REDONDO BASCULANTE

Lámpara no incluida - No Incluye portalámparas



ALUMINIO



Cromo mate ARO-008 72,06€



Blanco ARO-007 61,23€

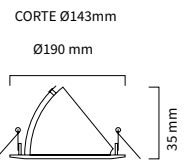

ARO BIONIQ REDONDO ORIENTABLE 360°

Lámpara no incluida - No Incluye portalámparas



ARO BIONIQ CUADRADO ORIENTABLE 360°

Lámpara no incluida - No Incluye portalámparas



Cromo mate ARO-010 21,51€

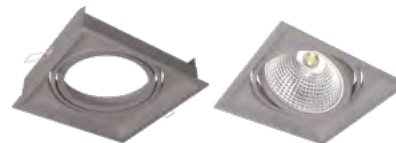
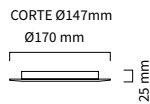

Cromo mate ARO-012 21,51€

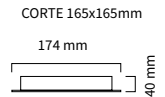

Hasta fin de existencias

ARO BIONIQ CIRCULAR BASCULANTE EMPOTRAR

Lámpara no incluida - Incluye portalámparas



ALUMINIO



Negro ARO-041 25,62€



Blanco ARO-040 25,62€

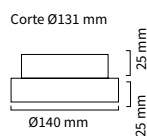

Serie Aros Especial tiendas - Aluminio

PARA
BOMBILLA QR111



-Aro basculante para QR111 - Lámpara no incluida

ARO BIONIQ CUADRADO BASCULANTE



ALUMINIO

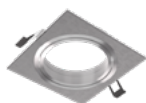

Aluminio brushed
ARO-027



Negro
ARO-028



Blanco
ARO-026

PVPR
33,06€

ARO-027
No incluye portalámparas

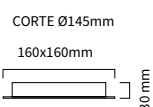

ARO-026/028
Incluye portalámparas

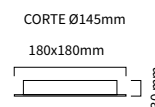

Lámpara no incluida - No Incluye portalámparas

ARO BIONIQ CIRCULAR BASCULANTE



Aluminio brushed
ARO-036

PVPR
17,70€



Negro
ARO-037

PVPR
19,89€



Blanco
ARO-130

PVPR
17,70€

CORTE Ø140mm

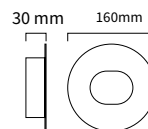

Lámpara no incluida - Incluye portalámparas

ARO BIONIQ CUADRADO BASCULANTE DOBLE



Aluminio brushed
ARO-030



Negro
ARO-031

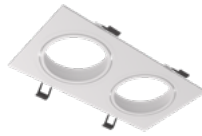

Blanco
ARO-029

PVPR
66,24€

CORTE 330x150mm

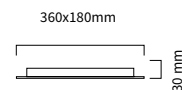

Lámpara no incluida - No Incluye portalámparas

ARO BIONIQ CUADRADO BASCULANTE TRIPLE



Aluminio brushed
ARO-033



Negro
ARO-034



Blanco mate
ARO-032

PVPR
97,86€

CORTE 450x145mm
465x160mm

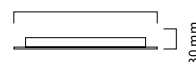

Serie Aros Especial tiendas - Material PC

PARA
BOMBILLA QR111
Y PAR27

QR111

E27



NEW!



Accesorio **unión** entre Aros

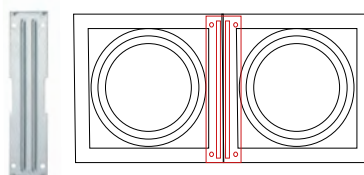

ACLED-464

UNIÓN ENTRE AROS
120 x 24.8 x 5.9MM

-Para QR111 - GU10 - Material PC
Lámpara no incluida - Incluye portalámparas



MATERIAL PC

CORTE 157x157mm

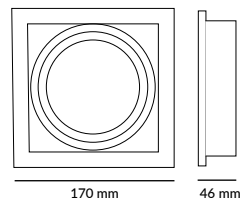

Blanco
ARO-106

Negro
ARO-107

PVPR
10,35€



CORTE 157x157mm

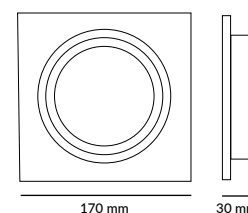

Blanco
ARO-110

Negro
ARO-111

PVPR
10,80€



-Para PAR30 E27 - Material PC
Lámpara no incluida - Incluye portalámparas



MATERIAL PC

CORTE 157x157mm

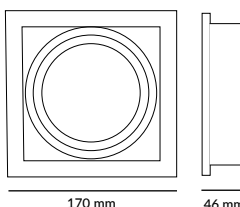

Blanco
ARO-104

Negro
ARO-105

PVPR
10,35€

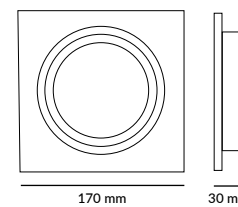
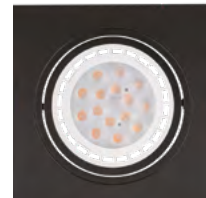

Blanco
ARO-108

Negro
ARO-109

PVPR
10,80€

* Según la nueva normativa ERP ha habido un cambio en la medición de Lúmenes y vatios, pero sigue emitiendo la misma cantidad de luz.

A medida que vayan entrando los nuevos modelos con ERP se irá actualizando en catálogo y cajas de color.

Puede haber variación respecto la caja del producto (comprobar en ficha técnica), todos los datos en catálogo están correctos salvo error tipográfico.

Serie Aros Especial tiendas - Material PC

PARA
BOMBILLA QR111
Y PAR27

QR111

E27



-Para GU10 - Material PC
Lámpara no incluida

GU10

QR111



MATERIAL PC

NEW!



Blanco
ARO-114 **PVPR**
9,90€

Corte
Ø145mm

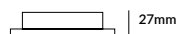

Negro
ARO-115 **PVPR**
9,90€

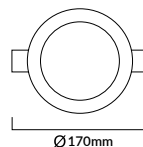

-Para PAR30 E27 - Material PC
Lámpara no incluida
BLED-118-119-120

E27



Blanco
ARO-112 **PVPR**
9,90€

Corte
Ø145mm

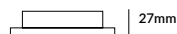

Negro
ARO-113 **PVPR**
9,90€

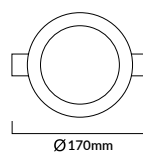

Serie Aros Especial tiendas - Material PC

PARA
BOMBILLA QR111



-Para QR111 - GU10 - Material PC
Lámpara no incluida



MATERIAL PC

NEW!



ARO PC-160 REDONDO QR111

Basculante blanco

REF

PVPR

ARO-131

7,62€

MÁX 15w IP 20 100



ARO PC-160 REDONDO QR111

Basculante negro

ARO-132

7,62€

MÁX 15w IP 20 100



ARO PC-160 REDONDO QR111

Basculante blanco y negro

ARO-133

7,62€

MÁX 15w IP 20 100

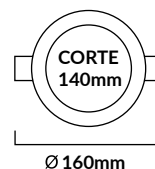

ARO PC-160X160 CUADRADO QR111

Basculante blanco

REF

PVPR

ARO-134

8,04€

MÁX 15w IP 20 100



ARO PC-160X160 CUADRADO QR111

Basculante negro

ARO-135

8,04€

MÁX 15w IP 20 100

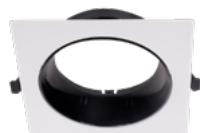
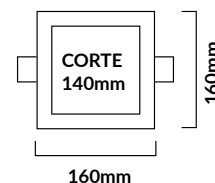

ARO PC-160X160 CUADRADO QR111

Basculante blanco y negro

ARO-136

8,04€

MÁX 15w IP 20 100



* Según la nueva normativa ERP ha habido un cambio en la medición de Lúmenes y vatios, pero sigue emitiendo la misma cantidad de luz.

A medida que vayan entrando los nuevos modelos con ERP se irá actualizando en catálogo y cajas de color.

Puede haber variación respecto la caja del producto (comprobar en ficha técnica), todos los datos en catálogo están correctos salvo error tipográfico.



Serie **Apliques**



3 en 1 TRES TIPOS DE LUZ
EN LA MISMA LUMINARIA

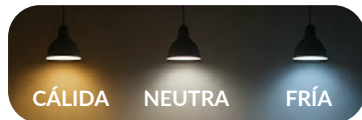

Switch
3CCT



NEW!
Carga por
USB TIPO-C



Batería 4000mAh
RECARGABLE CARGA USB

MODO DE CONTROL
CONTROLADOR RF 2.4Ghz

			Ref	PVPR
APLIQUE INTERIOR 3CCT BATERIA SENSOR PIR	Blanco	3CCT	APQ-240	26,85€
APLIQUE INTERIOR 3CCT BATERIA SENSOR PIR	Negro	3CCT	APQ-241	26,85€

FÁCIL
INSTALACIÓN

100
Lm

IP
20

SENSOR PIR
DE MOVIMIENTO

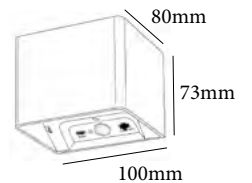

* Según la nueva normativa ERP ha habido un cambio en la medición de Lúmenes y vatios, pero sigue emitiendo la misma cantidad de luz. A medida que vayan entrando los nuevos modelos con ERP se irá actualizando en catálogo y cajas de color. Puede haber variación respecto la caja del producto (comprobar en ficha técnica), todos los datos en catálogo están correctos salvo error tipográfico.



Serie APLIQUES INTERIOR ALUMINIO

IP 20



LED INCLUIDO

SERIE ALUMINIO

					Ref	PVPR
TRACK-LIGHT PARED	2W	ALUMINIO	BLANCO	3200K	TRCK-103	46,74€
TRACK-LIGHT PARED	2W	ALUMINIO	NEGRO	3200K	TRCK-104	46,74€

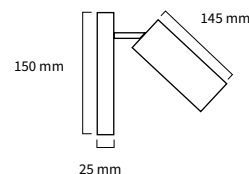

BOTÓN ON/OFF



Tipo A y C



Tipo A - 2000mAh
Tipo C - 3000mAh



BOTÓN ON/OFF

LED NO INCLUIDO

SERIE ALUMINIO

Para Dicroica Gu10, No incluida - Incluye portalámparas - LUZ EN 1 DIRECCIÓN

			Ref	PVPR
APLIQUE INTERIOR DE SUPERFICIE AT-426	Blanco - Lámpara GU10	APQ-035	20,22€	
APLIQUE INTERIOR DE SUPERFICIE AT-426	Negro - Lámpara GU10	APQ-036	20,22€	



Aplique para 1 lámpara

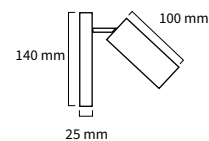



APLIQUES INTERIOR

IP 20

NEW!



LED NO INCLUIDO

SERIE ALUMINIO

	SUPERFICIE	GUIO	ALUMINIO	BLANCO	Ref	PVPR
LÁMPARA COLGANTE					TRCK-101	34,32€
LÁMPARA COLGANTE				NEGRO	TRCK-102	34,32€

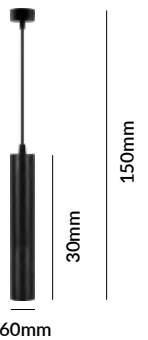

IP 20



LUZ EN DOS DIRECCIONES

NEW!



LED INCLUIDO

SERIE ALUMINIO

LUZ EN 2 DIRECCIONES

					Ref	PVPR
APLIQUE LED INTERIOR CUADRADO	Negro	6W	3200K	●	APQ-501	16,80€
APLIQUE LED INTERIOR CUADRADO	Negro	6W	5000K	●	APQ-502	16,80€
APLIQUE LED INTERIOR CUADRADO	Blanco	6W	3200K	●	APQ-503	16,80€
APLIQUE LED INTERIOR CUADRADO	Blanco	6W	5000K	●	APQ-504	16,80€

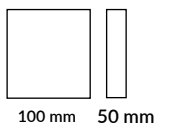

Serie APLIQUES INTERIOR ALUMINIO



PARA
BOMBILLA G9



SERIE ALUMINIO



Para Lámpara G9 No incluida - Incluye portalámparas - LUZ EN DOS DIRECCIONES

APLIQUE INTERIOR DE SUPERFICIE AT-40I
APLIQUE INTERIOR DE SUPERFICIE AT-40I

Blanco - Lámpara G9
Negro - Lámpara G9

Ref PVPR

APQ-029 26,40€
APQ-030 26,40€

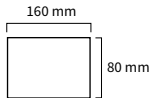

Aplique para 1 lámpara

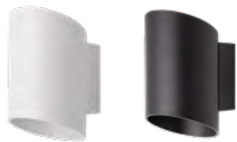

Para Lámpara G9 No incluida - Incluye portalámparas - LUZ EN DOS DIRECCIONES

APLIQUE INTERIOR DE SUPERFICIE AT-402
APLIQUE INTERIOR DE SUPERFICIE AT-402

Blanco - Lámpara G9
Negro - Lámpara G9

APQ-031 20,67€
APQ-032 20,67€

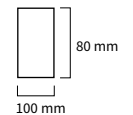

Aplique para 1 lámpara



Para Lámpara G9 No incluida - Incluye portalámparas - LUZ EN DOS DIRECCIONES

APLIQUE INTERIOR DE SUPERFICIE AT-403
APLIQUE INTERIOR DE SUPERFICIE AT-403

Blanco - Lámpara G9
Negro - Lámpara G9

APQ-033 26,40€
APQ-034 26,40€

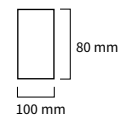

Aplique para 1 lámpara

APLIQUES INTERIOR

IP 20

PARA BOMBILLA G9



SERIE ALUMINIO



Con reposición de G9 (No incluida) - Incluye portalámparas

		Ref	PVPR
APLIQUE INTERIOR REDONDO ALUMINIO	Para lámpara G9 Blanco	APQ-462	18,24€
APLIQUE INTERIOR REDONDO ALUMINIO	Para lámpara G9 Negro	APQ-463	18,24€

MÁX30W



230 VDC

IP 20



Aplique para 1 lámpara

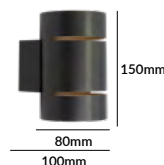

Con reposición de G9 (No incluida) - Incluye portalámparas

APLIQUE INTERIOR RECTANGULAR ALUMINIO	Para lámpara G9 Blanco	APQ-464	20,34€
APLIQUE INTERIOR RECTANGULAR ALUMINIO	Para lámpara G9 Negro	APQ-465	20,34€

MÁX30W



230 VDC

IP 20



Aplique para 1 lámpara

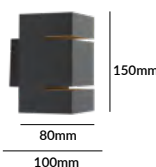

Con reposición de G9 (No incluida) - Incluye portalámparas

APLIQUE INTERIOR CUADRADO ALUMINIO	Para lámpara G9 Blanco	APQ-466	19,86€
APLIQUE INTERIOR CUADRADO ALUMINIO	Para lámpara G9 Negro	APQ-467	19,86€

MÁX30W



230 VDC

IP 20



Aplique para 1 lámpara

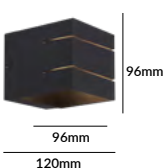

Serie APLIQUES EXTERIOR ALUMINIO

IP
65

PARA
BOMBILLA E27



NEW!



SERIE ALUMINIO

PANEL-CRISTAL

			Ref	PVPR
APLIQUE DE PARED CON PANEL DE CRISTAL	<i>Negro</i>	<i>MÁX 28W</i>	APQ-484	40,92€
APLIQUE DE PARED CON PANEL DE CRISTAL	<i>Blanco</i>	<i>MÁX 28W</i>	APQ-549	-----

Lámpara para Bombilla E27
(Bombilla no incluida)

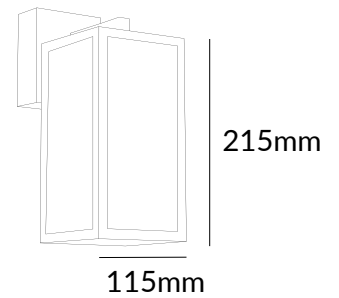

APLIQUES EXTERIOR

IP 65

PARA
DICROICA GU10



SERIE ALUMINIO

LUZ EN 1 DIRECCION



Para Lámpara Gu10 No incluida - Incluye portalámparas

	Ref	PVPR
APLIQUE EXTERIOR ALUMINIO CIRCULAR SUPERFICIE Negro - Lámpara GU10	APQ-080	20,85€
APLIQUE EXTERIOR ALUMINIO CIRCULAR SUPERFICIE Blanco - Lámpara GU10	APQ-081	20,85€
APLIQUE EXTERIOR ALUMINIO CIRCULAR SUPERFICIE Gris - Lámpara GU10	ARO-058	18,51€



Aplique para 1 lámpara

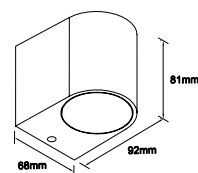

Para Lámpara Gu10 No incluida - Incluye portalámparas

	Ref	PVPR
APLIQUE EXTERIOR ALUMINIO CUADRADO SUPERFICIE Negro - Lámpara GU10	APQ-084	20,85€
APLIQUE EXTERIOR ALUMINIO CUADRADO SUPERFICIE Blanco - Lámpara GU10	APQ-085	20,85€



Aplique para 1 lámpara

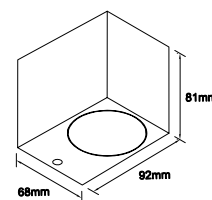

LUZ EN 2 DIRECCIONES



Para Lámpara Gu10 No incluida - Incluye portalámparas

	Ref	PVPR
APLIQUE EXTERIOR ALUMINIO CIRCULAR SUPERFICIE Negro - Lámpara GU10	APQ-082	29,07€
APLIQUE EXTERIOR ALUMINIO CIRCULAR SUPERFICIE Blanco - Lámpara GU10	APQ-083	29,07€
APLIQUE EXTERIOR ALUMINIO CIRCULAR SUPERFICIE Gris - Lámpara GU10	ARO-061	27,18€



Aplique para 2 lámparas

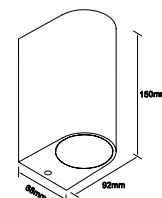

Para Lámpara Gu10 No incluida - Incluye portalámparas

	Ref	PVPR
APLIQUE EXTERIOR ALUMINIO CUADRADO SUPERFICIE Negro - Lámpara GU10	APQ-086	29,40€
APLIQUE EXTERIOR ALUMINIO CUADRADO SUPERFICIE Blanco - Lámpara GU10	APQ-087	29,40€



Aplique para 2 lámparas

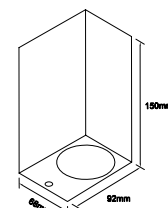

APLIQUES
EXTERIOR



LED INCLUIDO

3 en 1 TRES TIPOS DE LUZ
EN LA MISMA LUMINARIA

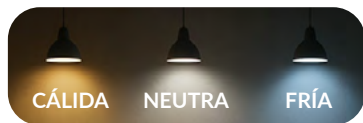

Switch
3CCT



SERIE PLASTIC



* Led incluido

ALTA
LUMINOSIDAD

ESPECIAL
FACHADA

K°

Ref

PVPR

APLIQUE EXTERIOR CIRCULAR

18W 60°

3CCT



APQ-377

22,68 €

APLIQUE EXTERIOR RECTANGULAR

18W 60°

3CCT



APQ-378

23,16 €

18w

1600
Lm

60°

230
V

IP
65



165 mm

Φ 81 mm

102 mm



165 mm

81 mm

102 mm

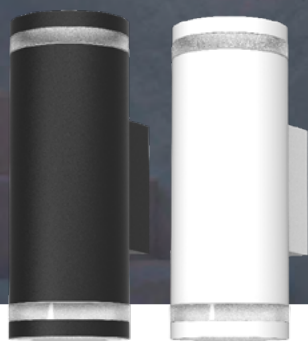

APLIQUES EXTERIOR

IP 65

PARA
DICROICA GU10



* Led NO INCLUIDO - Incluye portalámparas

SERIE ALUMINIO

			Ref	PVPR
APLIQUE EXTERIOR CIRCULAR ANILLO	Negro	MÁX 7W	APQ-480	35,52€
APLIQUE EXTERIOR CIRCULAR ANILLO	Blanco	MÁX 7W	APQ-481	35,52€

Aplique para Bombilla GU10
(Bombilla no incluida)



Aplique para 2 lámparas

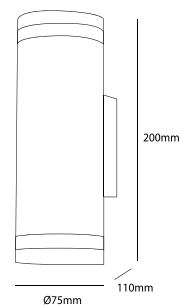

* Led NO INCLUIDO - Incluye portalámparas

SERIE ALUMINIO

			Ref	PVPR
APLIQUE EXTERIOR RECTANGULAR ANILLO	Negro	MÁX 7W	APQ-309	38,85€
APLIQUE EXTERIOR RECTANGULAR ANILLO	Blanco	MÁX 7W	APQ-310	38,85€

Aplique para Bombilla GU10
(Bombilla no incluida)



Aplique para 2 lámparas

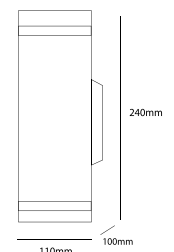

* Led NO INCLUIDO - Incluye portalámparas

SERIE PLASTIC

			Ref	PVPR
APLIQUE EXTERIOR RECTANGULAR ANILLO	Negro	MÁX 7W	APQ-482	27,90€
APLIQUE EXTERIOR RECTANGULAR ANILLO	Blanco	MÁX 7W	APQ-483	27,90€

Aplique para Bombilla GU10
(Bombilla no incluida)



Aplique para 2 lámparas

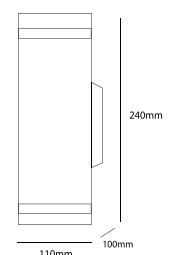

APLIQUES EXTERIOR



PARA
DICROICA GU10



SERIE ALUMINIO



Para Lámpara **Gu10 No incluida - Incluye portalámparas**

	Ref	PVPR
APLIQUE EXTERIOR ALUMINIO CUADRADO SUPERFICIE <i>Negro - Lámpara GU10</i>	APQ-300	30,78€
APLIQUE EXTERIOR ALUMINIO CUADRADO SUPERFICIE <i>Blanco - Lámpara GU10</i>	APQ-535	-----



110 mm



Aplique para 1 lámparas



Para Lámpara **Gu10 No incluida - Incluye portalámparas**

	Ref	PVPR
APLIQUE EXTERIOR ALUMINIO CUADRADO SUPERFICIE <i>Negro - Lámpara GU10</i>	APQ-301	56,70€
APLIQUE EXTERIOR ALUMINIO CUADRADO SUPERFICIE <i>Blanco - Lámpara GU10</i>	APQ-534	-----



210 mm



Aplique para 2 lámparas





**APLIQUES
EXTERIOR**



LED INCLUIDO

**3 en 1 TRES TIPOS DE LUZ
EN LA MISMA LUMINARIA**

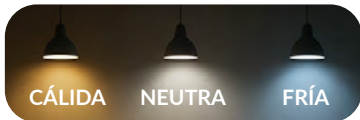

Switch
3CCT



SERIE PLASTIC



* Led incluido

**ALTA
LUMINOSIDAD**

**ESPECIAL
FACHADA**

	K°	Ref	PVPR
APLIQUE EXTERIOR CIRCULAR ANILLO TRANSPARENTE	18W 60° 3CCT	APQ-379	26,46 €
APLIQUE EXTERIOR CUADRADO ANILLO TRANSPARENTE	18W 60° 3CCT	APQ-380	27,96 €

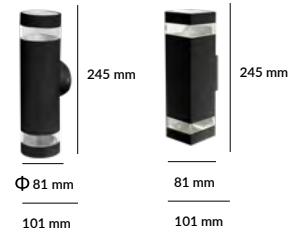

APLIQUES EXTERIOR



LED INCLUIDO

SERIE ALUMINIO



* Led incluido

APLIQUE PARED IP65 10W NEGRO

K°

Ref

PVPR

3200K ● APQ-068 56,10€

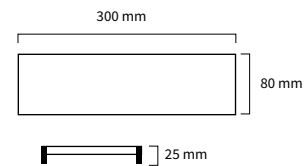

* Led incluido

APLIQUE PARED IP65 20W NEGRO

K°

Ref

PVPR

3200K ● APQ-069 89,73€

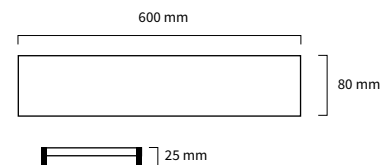

* Led incluido

APLIQUE PARED IP65 30W NEGRO

K°

Ref

PVPR

3200K ● APQ-070 129,66€

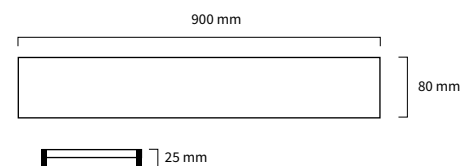



**APLIQUES
EXTERIOR**



LED INCLUIDO

SERIE PLASTIC



* Led incluido

LUZ EN 2 DIRECCIONES

			K°	Ref	PVPR
APLIQUE EXTERIOR RECTANGULAR UP&DOWN	12W	60°	3200K	APQ-375	10,56 €
APLIQUE EXTERIOR RECTANGULAR UP&DOWN	12W	60°	5000K	APQ-376	10,56 €

12w

1200
Lm

60°

230
VOC

IP
65



Aplique para 2 lámparas



144 mm

80 mm

APLIQUES EXTERIOR



PARA
BOMBILLA G9



SERIE APLIQUE LUZ AJUSTABLE



DISEÑO CON HAZ DE LUZ AJUSTABLE

El aplique de pared puede ajustar la luz de diferentes ángulos, y también puede iluminar un lado.

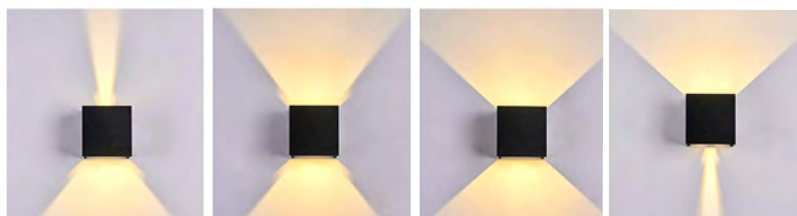

Aplique para Bombilla G9
(Bombilla no incluida)



* Led NO INCLUIDO - Incluye portalámparas

SERIE ALUMINIO

		Ref	PVPR
APLIQUE EXTERIOR CUADRADO ALUMINIO	Negro MÁX 4W	APQ-478	26,82€
APLIQUE EXTERIOR CUADRADO ALUMINIO	Blanco MÁX 4W	APQ-479	26,82€

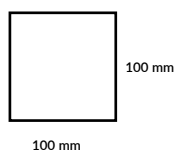

Aplique para Bombilla G9
(Bombilla no incluida)



* Led NO INCLUIDO - Incluye portalámparas

SERIE ALUMINIO

		Ref	PVPR
APLIQUE EXTERIOR OVAL ALUMINIO	Negro MÁX 6W	APQ-476	27,60€
APLIQUE EXTERIOR OVAL ALUMINIO	Blanco MÁX 6W	APQ-477	27,60€

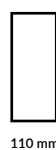
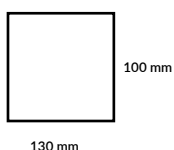



* Led incluido - Ángulo ajustable

SERIE ALUMINIO

		K°	Ref	PVPR
	APLIQUE EXTERIOR CUADRADO ALUMINIO	Negro 10W Ajustable°	3000K	APQ-419 25,14 €
NEW!	APLIQUE EXTERIOR CUADRADO ALUMINIO	Negro 10W Ajustable°	4200K	APQ-439 25,14 €
	APLIQUE EXTERIOR CUADRADO ALUMINIO	Negro 10W Ajustable°	5000K	APQ-420 25,14 €
	APLIQUE EXTERIOR CUADRADO ALUMINIO	Blanco 10W Ajustable°	3000K	APQ-421 25,14 €
NEW!	APLIQUE EXTERIOR CUADRADO ALUMINIO	Blanco 10W Ajustable°	4200K	APQ-440 25,14 €
	APLIQUE EXTERIOR CUADRADO ALUMINIO	Blanco 10W Ajustable°	5000K	APQ-422 25,14 €

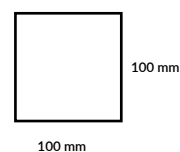

* Led incluido - Ángulo ajustable

SERIE PLASTIC

		K°	Ref	PVPR
	APLIQUE EXTERIOR CUADRADO PLS	Negro 10W Ajustable°	6000K	APQ-469 16,47 €

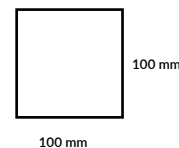

3 en 1 TRES TIPOS DE LUZ EN LA MISMA LUMINARIA

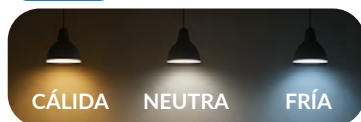

* Led incluido - Ángulo ajustable

SERIE ALUMINIO

		K°	Ref	PVPR
	APLIQUE EXTERIOR CUADRADO ALUMINIO	Negro 6W	3CCT	APQ-474 36,36 €
	APLIQUE EXTERIOR CUADRADO ALUMINIO	Blanco 6W	3CCT	APQ-475 36,36 €

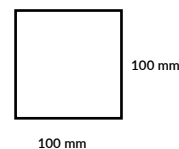

* Led incluido - Ángulo ajustable

SERIE ALUMINIO

		K°	Ref	PVPR
	APLIQUE EXTERIOR OVAL ALUMINIO	Negro 6W	3CCT	APQ-472 39,54 €
	APLIQUE EXTERIOR OVAL ALUMINIO	Blanco 6W	3CCT	APQ-473 39,54 €

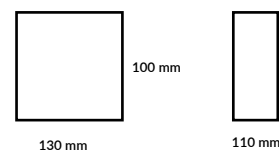

* Según la nueva normativa ERP ha habido un cambio en la medición de Lúmenes y vatios, pero sigue emitiendo la misma cantidad de luz. A medida que vayan entrando los nuevos modelos con ERP se irá actualizando en catálogo y cajas de color. Puede haber variación respecto la caja del producto (comprobar en ficha técnica), todos los datos en catálogo están correctos salvo error tipográfico.

APLIQUES EXTERIOR



LED INCLUIDO

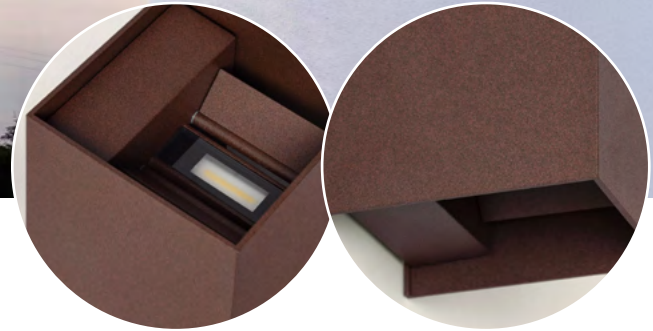

ACABADO CORTEN

SERIE ALUMINIO

* Led incluido - Ángulo ajustable

APLIQUE EXTERIOR CUADRADO ALUMINIO *Corten 10W Ajustable°*
3000K ● APQ-442 27,72 €

APLIQUE EXTERIOR CUADRADO ALUMINIO *Corten 10W Ajustable°*
4200K ● APQ-443 27,72 €

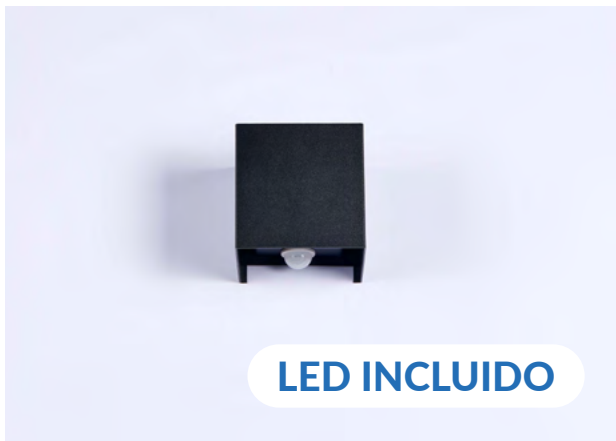
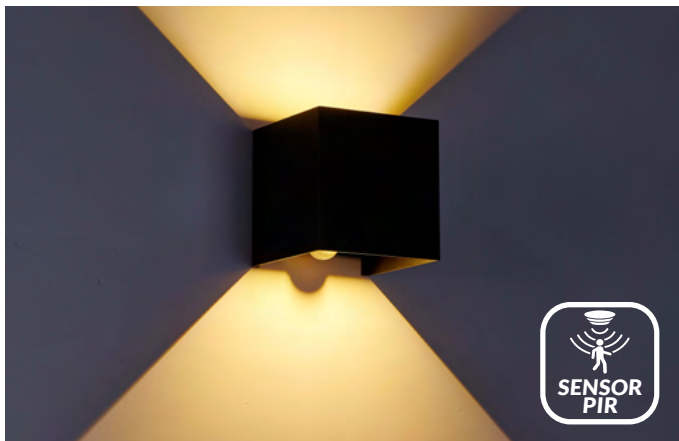
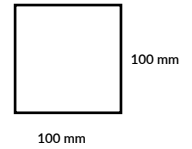

LED INCLUIDO

NEW!



LED INCLUIDO

SERIE ALUMINIO

				Ref	PVPR
APLIQUE LED EXTERIOR CUADRADO	Negro	10W	3200K ●	APQ-488	31,62€
APLIQUE LED EXTERIOR CUADRADO	Blanco	10W	3200K ●	APQ-538	31,62€



- Distancia detección 3 mts
- Tiempo encendido 30-40 seg

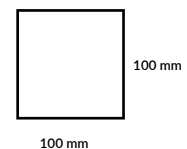

APLIQUES
EXTERIOR



LED INCLUIDO

3 en 1 TRES TIPOS DE LUZ
EN LA MISMA LUMINARIA

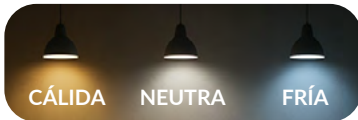

CÁLIDA

NEUTRA

FRÍA



Switch
3CCT



NEW!



SERIE ALUMINIO

* Led incluido

		K°	Ref	PVPR
APLIQUE EXTERIOR ALUMINIO 3CCT	Negro 6W	3CCT	APQ-470	37,86 €
APLIQUE EXTERIOR ALUMINIO 3CCT	Blanco 6W	3CCT	APQ-532	-----

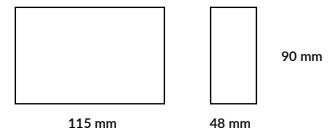

NEW!



SERIE ALUMINIO

* Led incluido

		K°	Ref	PVPR
APLIQUE EXTERIOR ALUMINIO 3CCT	Negro 12W	3CCT	APQ-471	40,20 €
APLIQUE EXTERIOR ALUMINIO 3CCT	Blanco 12W	3CCT	APQ-531	-----

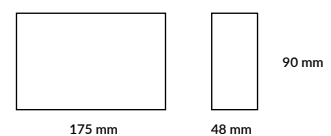

APLIQUES EXTERIOR



LED INCLUIDO



SERIE ALUMINIO

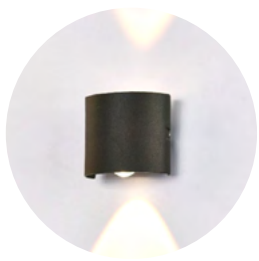

* Led incluido

K°	Ref	PVPR
●	APQ-423	11,52 €
●	APQ-424	11,52 €

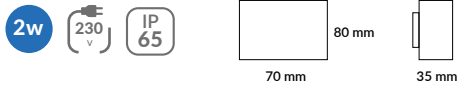

* Led incluido

K°	Ref	PVPR
●	APQ-427	14,64 €
●	APQ-428	14,64 €

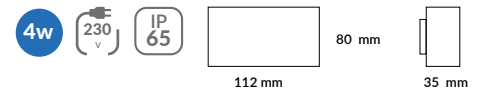

* Led incluido

K°	Ref	PVPR
●	APQ-431	17,88 €
●	APQ-432	17,88 €

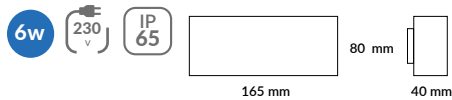

* Led incluido

K°	Ref	PVPR
●	APQ-435	22,50 €
●	APQ-436	22,50 €

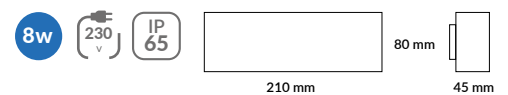



SERIE ALUMINIO



* **Led incluido** K° Ref PVPR

APLIQUE EXTERIOR 2LED
2W - Blanco - 3200K ● APQ-425 11,52 €

APLIQUE EXTERIOR 2LED
2W - Blanco - 5000K ● APQ-426 11,52 €

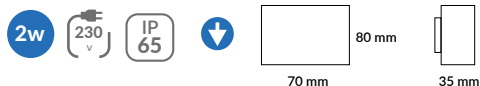

* **Led incluido**

APLIQUE EXTERIOR 4LED
4W - Blanco - 3200K ● APQ-429 14,64 €

APLIQUE EXTERIOR 4LED
4W - Blanco - 5000K ● APQ-430 14,64 €

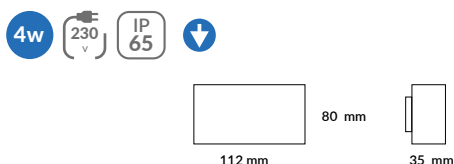

* **Led incluido**

APLIQUE EXTERIOR 6LED
6W - Blanco - 3200K ● APQ-433 17,88 €

APLIQUE EXTERIOR 6LED
6W - Blanco - 5000K ● APQ-434 17,88 €

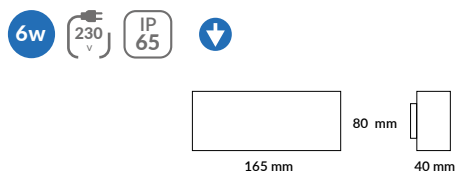

* **Led incluido**

APLIQUE EXTERIOR 8LED
8W - Blanco - 3200K ● APQ-437 22,50 €

APLIQUE EXTERIOR 8LED
8W - Blanco - 5000K ● APQ-438 22,50 €

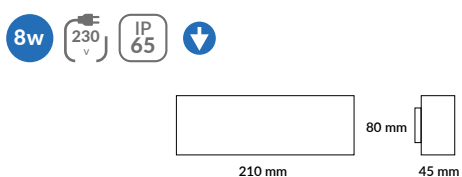

APLIQUES
EXTERIOR 

LED INCLUIDO



APLIQUES EXTERIOR



LED INCLUIDO

SERIE PLASTIC



* Led incluido

APLIQUE EXTERIOR AT-I4-2 *Negro 2W* DUAL COLOR Ref APQ-365 PVPR 11,34 €

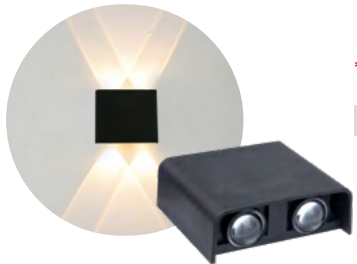
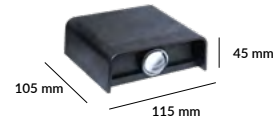

* Led incluido

APLIQUE EXTERIOR AT-I4-2 *Negro 4W* DUAL COLOR Ref APQ-366 PVPR 13,62 €

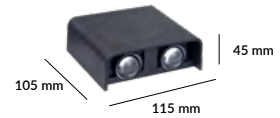

* Led incluido

APLIQUE EXTERIOR AT-I4-2 *Negro 6W* DUAL COLOR Ref APQ-367 PVPR 16,62 €



* Led incluido

APLIQUE EXTERIOR AT-I4-2 *Negro 8W* DUAL COLOR Ref APQ-368 PVPR 21,18 €





APLIQUES EXTERIOR TECHO



PARA
DICROICA GU10



SERIE ALUMINIO



* Led no incluido

				Ref	PVPR
APLIQUE TECHO EXTERIOR	CIRCULAR	IP65	NEGRO	APQ-303	21,63€
APLIQUE TECHO EXTERIOR	CIRCULAR	IP65	BLANCO	APQ-304	21,63€

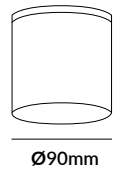

* Led no incluido

				Ref	PVPR
APLIQUE TECHO EXTERIOR	CIRCULAR	IP65	BLANCO	APQ-311	-----
APLIQUE TECHO EXTERIOR	CIRCULAR	IP65	NEGRO	APQ-312	-----

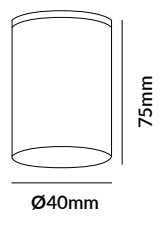

* Led no incluido

				Ref	PVPR
APLIQUE TECHO EXTERIOR	CIRCULAR	IP65	NEGRO	APQ-305	29,40€
APLIQUE TECHO EXTERIOR	CIRCULAR	IP65	BLANCO	APQ-306	29,40€

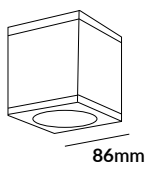

* Según la nueva normativa ERP ha habido un cambio en la medición de Lúmenes y vatios, pero sigue emitiendo la misma cantidad de luz. A medida que vayan entrando los nuevos modelos con ERP se irá actualizando en catálogo y cajas de color. Puede haber variación respecto la caja del producto (comprobar en ficha técnica), todos los datos en catálogo están correctos salvo error tipográfico.

Serie APLIQUES LUZ UNIFORME

IP 65

PARA
BOMBILLA VINTAGE



Para una **LUZ UNIFORME**
utilizar **BOMBILLAS VINTAGE**



Bombilla Vintage



LUZ UNIFORME

Compatible con las bombillas Vintage

BLED-390-391-392 - 6W
BLED-405-406-407 - 10W
BLED-170-171-172-174-176 - 4W
BLED-177-178-179-237-238 - 8W



LED NO INCLUIDO

SERIE ALUMINIO
DIFUSOR VIDRIO

			Ref	PVPR
APLIQUE LED EXTERIOR	Blanco	E27	APQ-507	8,85€
APLIQUE LED EXTERIOR	Negro	E27	APQ-508	8,85€

MÁX 60w

230 V

IP 65



Bombilla Vintage



LUZ UNIFORME



LED NO INCLUIDO

SERIE ALUMINIO
DIFUSOR VIDRIO

			Ref	PVPR
APLIQUE LED EXTERIOR	Blanco	E27	APQ-509	8,85€
APLIQUE LED EXTERIOR	Negro	E27	APQ-510	8,85€

MÁX 60w

230 V

IP 65



Bombilla Vintage



LUZ UNIFORME



APLIQUES EXTERIOR

IP 65

PARA BOMBILLA VINTAGE



LED NO INCLUIDO

SERIE ALUMINIO DIFUSOR VIDRIO

			Ref	PVPR
APLIQUE LED EXTERIOR	Blanco	E27	APQ-511	17,94€
APLIQUE LED EXTERIOR	Negro	E27	APQ-512	17,94€

MÁX 60w 230v IP 65



Bombilla Vintage



LUZ UNIFORME



LED NO INCLUIDO

SERIE ALUMINIO DIFUSOR VIDRIO

			Ref	PVPR
APLIQUE LED EXTERIOR	Blanco	E27	APQ-513	17,94€
APLIQUE LED EXTERIOR	Negro	E27	APQ-514	17,94€

MÁX 60w 230v IP 65



Bombilla Vintage



LUZ UNIFORME



LED NO INCLUIDO

SERIE ALUMINIO DIFUSOR VIDRIO

			Ref	PVPR
APLIQUE LED EXTERIOR	Blanco	E27	APQ-515	17,94€
APLIQUE LED EXTERIOR	Negro	E27	APQ-516	17,94€

MÁX 60w 230v IP 65



Bombilla Vintage



LUZ UNIFORME

APLIQUES EXTERIOR



PARA BOMBILLA VINTAGE



LED NO INCLUIDO

SERIE ALUMINIO DIFUSOR VIDRIO

			Ref	PVPR
APLIQUE LED EXTERIOR	Blanco	E27	APQ-517	17,85€
APLIQUE LED EXTERIOR	Negro	E27	APQ-518	17,85€



LED NO INCLUIDO

SERIE ALUMINIO DIFUSOR VIDRIO

			Ref	PVPR
APLIQUE LED EXTERIOR	Blanco	E27	APQ-519	17,85€
APLIQUE LED EXTERIOR	Negro	E27	APQ-520	17,85€



LED NO INCLUIDO

SERIE ALUMINIO DIFUSOR VIDRIO

			Ref	PVPR
APLIQUE LED EXTERIOR	Blanco	E27	APQ-521	22,50€
APLIQUE LED EXTERIOR	Negro	E27	APQ-522	22,50€





**APLIQUES
EXTERIOR**

**IP
65**

LED INCLUIDO

**3 en 1 TRES TIPOS DE LUZ
EN LA MISMA LUMINARIA**

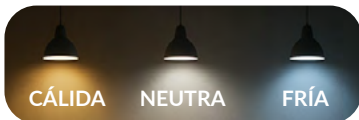

Switch
3CCT



SERIE PLASTIC

**2
DISEÑOS**
2 años
intercambiables



* Led incluido

**ALTA
LUMINOSIDAD**

**ESPECIAL
FACHADA**

APLIQUE LED EXTERIOR RECTANGULAR *Blanco 20W 100°* **3CCT** **APQ-523** **PVPR 17,10 €**



K° Ref PVPR

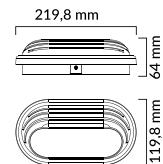

**2
DISEÑOS**
2 años
intercambiables



* Led incluido

**ALTA
LUMINOSIDAD**

**ESPECIAL
FACHADA**

APLIQUE LED EXTERIOR CIRCULAR *Blanco 15W 100°* **3CCT** **APQ-524** **PVPR 24,30 €**



K° Ref PVPR

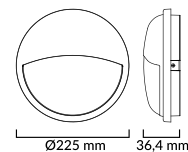

APLIQUES EXTERIOR



LED INCLUIDO

SERIE PLASTIC

* Led incluido



		K°	Ref	PVPR
APLIQUE LED EXTERIOR OVAL	12W 120°	3200K	APQ-007	11,04€
APLIQUE LED EXTERIOR OVAL	12W 120°	4200K	APQ-008	11,04€
APLIQUE LED EXTERIOR OVAL	12W 120°	5000K	APQ-009	11,04€
APLIQUE LED EXTERIOR CIRCULAR	12W 120°	3200K	APQ-010	11,04€
APLIQUE LED EXTERIOR CIRCULAR	12W 120°	4200K	APQ-011	11,04€
APLIQUE LED EXTERIOR CIRCULAR	12W 120°	5000K	APQ-012	11,04€

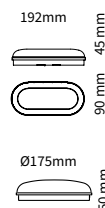

2 aros intercambiables



* Led incluido

APLIQUE LED EXTERIOR OVAL	Blanco 15W 100°	3200K	APQ-017	18,45€
APLIQUE LED EXTERIOR OVAL	Blanco 15W 100°	4200K	APQ-018	18,45€
APLIQUE LED EXTERIOR OVAL	Blanco 15W 100°	5000K	APQ-019	18,45€
APLIQUE LED EXTERIOR OVAL	Gris 15W 100°	3200K	APQ-020	18,45€
APLIQUE LED EXTERIOR OVAL	Gris 15W 100°	4200K	APQ-021	18,45€
APLIQUE LED EXTERIOR OVAL	Gris 15W 100	5000K	APQ-022	18,45€

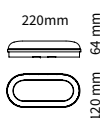

2 aros intercambiables



* Led incluido

APLIQUE LED EXTERIOR CIRCULAR	Blanco 20W 100°	3200K	APQ-023	26,01€
APLIQUE LED EXTERIOR CIRCULAR	Blanco 20W 100°	4200K	APQ-024	26,01€
APLIQUE LED EXTERIOR CIRCULAR	Blanco 20W 100°	5000K	APQ-025	26,01€
APLIQUE LED EXTERIOR CIRCULAR	Gris 20W 100°	3200K	APQ-026	26,01€
APLIQUE LED EXTERIOR CIRCULAR	Gris 20W 100°	4200K	APQ-027	26,01€
APLIQUE LED EXTERIOR CIRCULAR	Gris 20W 100	5000K	APQ-028	26,01€



Ø225mm



NEW



* Led incluido

APLIQUE LED EXTERIOR RECTANGULAR	Gris 20W 100°	4200K	APQ-043	20,91€
APLIQUE LED EXTERIOR RECTANGULAR	Gris 20W 100°	3CCT	APQ-094	20,97€

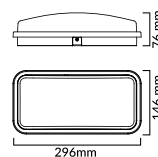

3 en 1 TRES TIPOS DE LUZ EN LA MISMA LUMINARIA

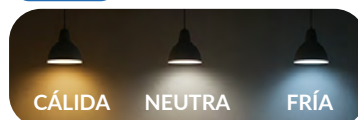



**APLIQUES
EXTERIOR**



LED INCLUIDO

**3 en 1 TRES TIPOS DE LUZ
EN LA MISMA LUMINARIA**



Switch
3CCT

SERIE PLASTIC

**ALTA
LUMINOSIDAD**

**ESPECIAL
FACHADA**



* Led incluido

			K°	Ref	PVPR	
APLIQUE EXTERIOR REDONDO	15W	100°	3CCT	APQ-381	21,18 €	↓
APLIQUE EXTERIOR CUADRADO	15W	100°	3CCT	APQ-382	21,18 €	↓

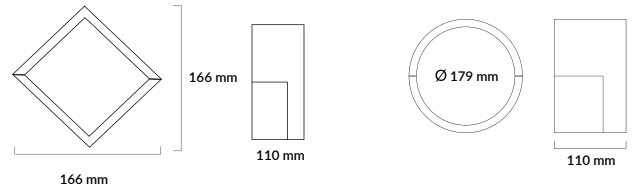

**3 en 1 TRES TIPOS DE LUZ
EN LA MISMA LUMINARIA**

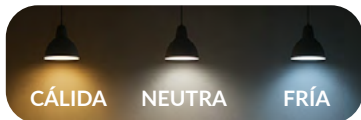

Switch
3CCT

SERIE PLASTIC

**ALTA
LUMINOSIDAD**

**ESPECIAL
FACHADA**

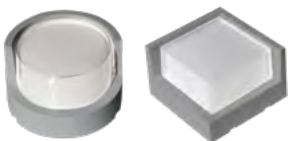

* Led incluido

			K°	Ref	PVPR
APLIQUE LED REDONDO	Gris - 15W	CCT	↓	APQ-486	20,22 €
APLIQUE LED CUADRADO	Gris - 15W	CCT	↓	APQ-487	20,22 €

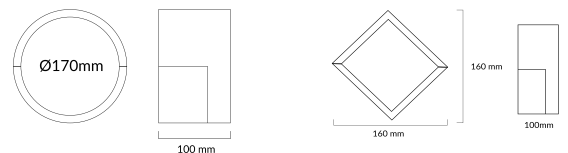

* Según la nueva normativa ERP ha habido un cambio en la medición de Lúmenes y vatios, pero sigue emitiendo la misma cantidad de luz. A medida que vayan entrando los nuevos modelos con ERP se irá actualizando en catálogo y cajas de color. Puede haber variación respecto la caja del producto (comprobar en ficha técnica), todos los datos en catálogo están correctos salvo error tipográfico.

APLIQUES EXTERIOR



LED INCLUIDO

SERIE PLASTIC



* Led incluido

ALTA LUMINOSIDAD

ESPECIAL FACHADA

		K°	Ref	PVPR
APLIQUE LED REDONDO	Gris - 15W	4200K	APQ-046	17,70€
APLIQUE LED CUADRADO	Gris - 15W	4200K	APQ-047	17,70€

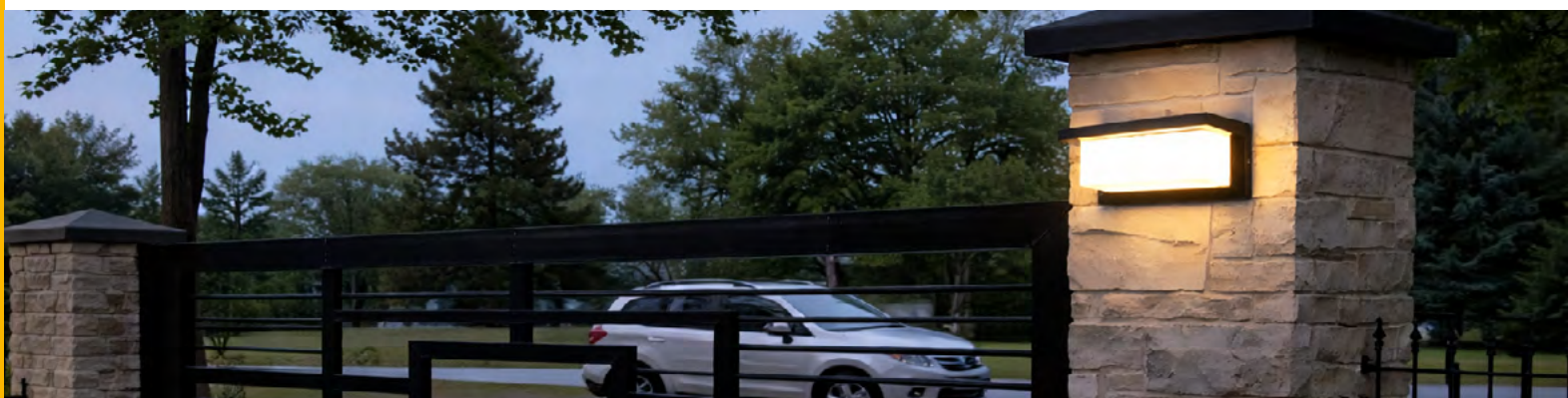
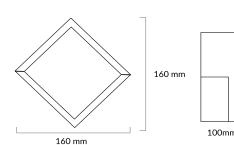
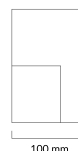

3 en 1 TRES TIPOS DE LUZ EN LA MISMA LUMINARIA

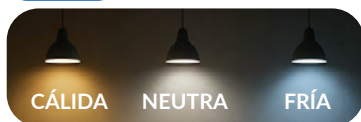

Switch 3CCT

SERIE PLASTIC

ALTA LUMINOSIDAD

ESPECIAL FACHADA



* Led incluido

		K°	Ref	PVPR	
APLIQUE EXTERIOR RECTANGULAR		24W 100°	3CCT	APQ-383	30,24 €
APLIQUE EXTERIOR RECTANGULAR		24W 100°	3CCT	APQ-384	30,24 €

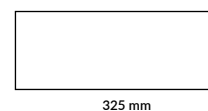



3 en 1 TRES TIPOS DE LUZ EN LA MISMA LUMINARIA



* Led incluido

	K°	Ref	PVPR	
APLIQUE EXTERIOR RECTANGULAR	6W 100°	3CCT	APQ-529	----

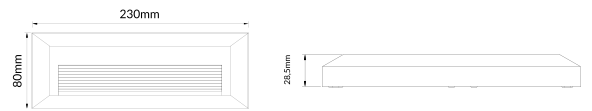

* Led incluido

	K°	Ref	PVPR	
APLIQUE EXTERIOR RECTANGULAR	6W 100°	3CCT	APQ-530	----

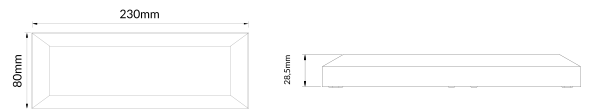



Serie Apliques de escalera

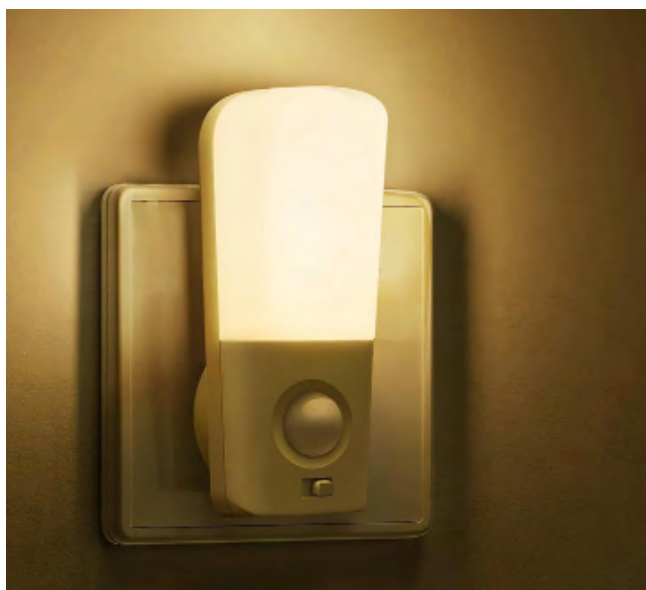

AUTO 1



OFF



AUTO 2

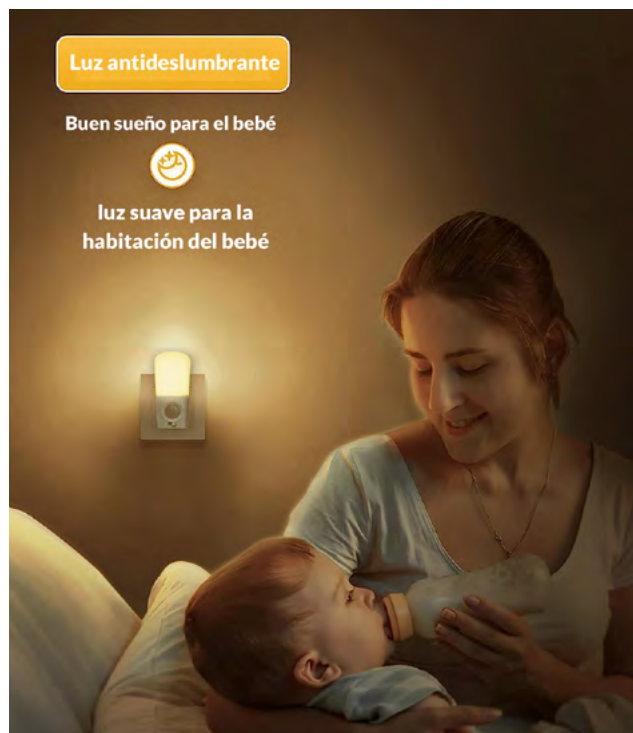
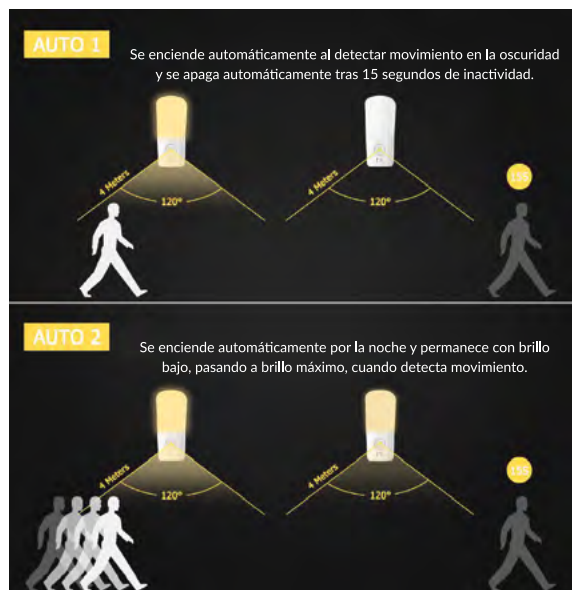

Pack de 2 uds

K°

Ref

PVPR

LUZ NOCTURNA CON SENSOR MOVIMIENTO 1W 80Lm 3200K ACLED-456 28,08€

1w

80 Lm

230 V

2

120°

SENSOR PIR DE MOVIMIENTO

SENSOR CREPUSCULAR



Sensor de movimiento PIR



Sensor crepuscular



3 modos de trabajo

Series MAGNETIC

Múltiples combinaciones Tapas intercambiables

1,5w | 3 CCT | IP20 | Aluminio

Compatible con
caja universal | Tornillos montaje
incluidos



NEW!



APQ-200 10,38€

Negro



APQ-224 2,55€ APQ-221 2,55€ APQ-227 2,55€

Blanco



APQ-223 2,55€ APQ-221 2,55€ APQ-226 2,55€

Aluminio



APQ-225 4,56€ APQ-222 4,56€ APQ-228 4,56€



APQ-206 2,55€ APQ-203 2,55€ APQ-209 2,55€



APQ-205 2,55€ APQ-202 2,55€ APQ-208 2,55€



APQ-207 4,56€ APQ-204 4,56€ APQ-210 4,56€

Sensor PIR - 1Metro detección

NEW!



APQ-201 16,89€

Negro



APQ-233 2,55€ APQ-230 2,55€ APQ-236 2,55€

Blanco



APQ-232 2,55€ APQ-229 2,55€ APQ-235 2,55€

Aluminio



APQ-234 4,56€ APQ-231 4,56€ APQ-237 4,56€



APQ-215 2,55€ APQ-212 2,55€ APQ-218 2,55€



APQ-217 2,55€ APQ-211 2,55€ APQ-217 2,55€



APQ-216 4,56€ APQ-213 4,56€ APQ-219 4,56€

* Según la nueva normativa ERP ha habido un cambio en la medición de Lúmenes y vatios, pero sigue emitiendo la misma cantidad de luz. A medida que vayan entrando los nuevos modelos con ERP se irá actualizando en catálogo y cajas de color. Puede haber variación respecto a la caja del producto (comprobar en ficha técnica), todos los datos en catálogo están correctos salvo error tipográfico.



LED INCLUIDO

Serie APLIQUES ESCALERA



LED INCLUIDO

SERIE ALUMINIO

			K°	Ref	PVPR
APLIQUE LED EXTERIOR EMPOTRADO	Negro	3W	2700K	APQ-506	11,70€
APLIQUE LED EXTERIOR EMPOTRADO	Blanco	3W	2700K	APQ-547	-----

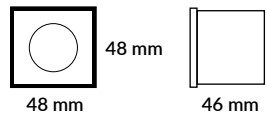
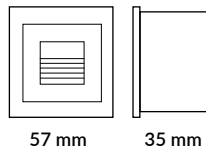

Cubierta protectora extraíble
Corte: 48x48x46mm



LED INCLUIDO

			K°	Ref	PVPR
APLIQUE LED ESCALERA CUADRADO	Blanco	1.6W	3000K	APQ-558	-----
APLIQUE LED ESCALERA CUADRADO	Negro	1.6W	3000K	APQ-559	-----
APLIQUE LED ESCALERA CUADRADO	Blanco	1.6W	3000K	APQ-560	-----
APLIQUE LED ESCALERA CUADRADO	Negro	1.6W	4000K	APQ-561	-----





NEW!

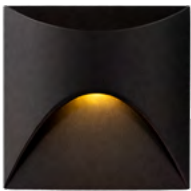

LED INCLUIDO

			K°	Ref	PVPR
APLIQUE ESCALERA EMPOTRADO	Blanco	3W	3000K	APQ-550	-----
APLIQUE ESCALERA EMPOTRADO	Blanco	3W	4000K	APQ-551	-----



			K°	Ref	PVPR
APLIQUE ESCALERA EMPOTRADO	Blanco	3W	3000K	APQ-552	-----
APLIQUE ESCALERA EMPOTRADO	Blanco	3W	4000K	APQ-553	-----



			K°	Ref	PVPR
APLIQUE ESCALERA EMPOTRADO	Blanco	3W	3000K	APQ-554	-----
APLIQUE ESCALERA EMPOTRADO	Blanco	3W	4000K	APQ-555	-----



			K°	Ref	PVPR
APLIQUE ESCALERA EMPOTRADO	Blanco	3W	3000K	APQ-556	-----
APLIQUE ESCALERA EMPOTRADO	Blanco	3W	4000K	APQ-557	-----



* Según la nueva normativa ERP ha habido un cambio en la medición de Lúmenes y vatios, pero sigue emitiendo la misma cantidad de luz. A medida que vayan entrando los nuevos modelos con ERP se irá actualizando en catálogo y cajas de color. Puede haber variación respecto la caja del producto (comprobar en ficha técnica), todos los datos en catálogo están correctos salvo error tipográfico.

APLIQUES EXTERIOR ESCALERA

IP 65

LED INCLUIDO



NEW!



LED INCLUIDO

SERIE ALUMINIO

			K°	Ref	PVPR
APLIQUE LED EXTERIOR CUADRADO	Negro	5W	2700K	APQ-505	27,75€
APLIQUE LED EXTERIOR CUADRADO	Negro	5W	3200K	APQ-497	27,75€
APLIQUE LED EXTERIOR CUADRADO	Negro	5W	4200K	APQ-498	27,75€
APLIQUE LED EXTERIOR CUADRADO	Negro	5W	2700K	APQ-546	27,75€
APLIQUE LED EXTERIOR CUADRADO	Negro	5W	3200K	APQ-543	27,75€
APLIQUE LED EXTERIOR CUADRADO	Negro	5W	4200K	APQ-544	27,75€

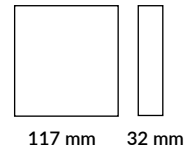

NEW!



LED INCLUIDO

SERIE ALUMINIO

			K°	Ref	PVPR
APLIQUE LED EXTERIOR CUADRADO	Negro	5W	3200K	APQ-499	36,24€
APLIQUE LED EXTERIOR CUADRADO	Negro	5W	4200K	APQ-500	36,24€
APLIQUE LED EXTERIOR CUADRADO	Blanco	5W	3200K	APQ-545	36,24€



- Distancia detección 3 mts
- Tiempo encendido 30-40 seg

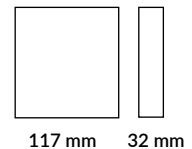



**APLIQUES
EXTERIOR
ESCALERA**

IP
65

LED INCLUIDO

NEW!



LED INCLUIDO

SERIE ALUMINIO

			K°	Ref	PVPR
APLIQUE LED EXTERIOR CUADRADO	Negro	3W	2700K	APQ-528	25,86€
APLIQUE LED EXTERIOR CUADRADO	Negro	3W	3200K	APQ-525	25,86€
APLIQUE LED EXTERIOR CUADRADO	Negro	3W	4200K	APQ-526	25,86€
APLIQUE LED EXTERIOR CUADRADO	Negro	3W	5000K	APQ-527	25,86€
APLIQUE LED EXTERIOR CUADRADO	Blanco	3W	2700K	APQ-548	25,86€

3w

230
v

IP
65



83 mm

83 mm

APLIQUES EXTERIOR ESCALERA



LED INCLUIDO



NEW!



LED INCLUIDO

SERIE ALUMINIO

				K°	Ref	PVPR
APLIQUE LED EXTERIOR REDONDO	Negro	3W		3200K	APQ-493	25,95€
APLIQUE LED EXTERIOR REDONDO	Negro	3W		4200K	APQ-494	25,95€
APLIQUE LED EXTERIOR REDONDO	Blanco	3W		3200K	APQ-541	25,95€

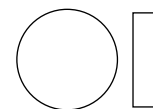

117 mm 32 mm

NEW!



LED INCLUIDO

SERIE ALUMINIO

				K°	Ref	PVPR
APLIQUE LED EXTERIOR REDONDO	Negro	3W		3200K	APQ-495	34,50€
APLIQUE LED EXTERIOR REDONDO	Negro	3W		4200K	APQ-496	34,50€
APLIQUE LED EXTERIOR REDONDO	Blanco	3W		3200K	APQ-542	34,50€



- Distancia detección 3 mts
- Tiempo encendido 30-40 seg

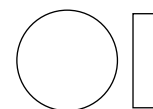

117 mm 32 mm



APLIQUES EXTERIOR ESCALERA

IP 65

LED INCLUIDO



NEW!

LED INCLUIDO

SERIE ALUMINIO

			K°	Ref	PVPR
APLIQUE LED EXTERIOR REDONDO	Negro	3W	3200K	APQ-489	23,76€
APLIQUE LED EXTERIOR REDONDO	Negro	3W	4200K	APQ-490	23,76€
APLIQUE LED EXTERIOR REDONDO	Blanco	3W	3200K	APQ-537	23,76€

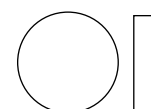

83 mm 26 mm



NEW!

LED INCLUIDO

SERIE ALUMINIO

			K°	Ref	PVPR
APLIQUE LED EXTERIOR REDONDO	Negro	3W	3200K	APQ-491	32,34€
APLIQUE LED EXTERIOR REDONDO	Negro	3W	4200K	APQ-492	32,34€
APLIQUE LED EXTERIOR REDONDO	Blanco	3W	3200K	APQ-540	32,34€



SENSOR PIR MOVIMIENTO

SENSOR CREPUSCULAR

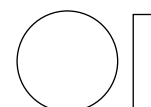

83 mm 26 mm

- Distancia detección 3 mts
- Tiempo encendido 30-40 seg

* Según la nueva normativa ERP ha habido un cambio en la medición de Lúmenes y vatios, pero sigue emitiendo la misma cantidad de luz. A medida que vayan entrando los nuevos modelos con ERP se irá actualizando en catálogo y cajas de color. Puede haber variación respecto la caja del producto (comprobar en ficha técnica), todos los datos en catálogo están correctos salvo error tipográfico.

Serie Apliques jardin

IP 65

PARA BOMBILLA E27



NEW!



SERIE ALUMINIO

Lámpara NO INCLUIDA - PANEL CRISTAL

LÁMPARA DE PIE EXTERIOR	Negro	PARA Lámpara E27	60CM ALTURA	Ref	PVPR
				APQ-485	47,82€



350mm



LÁMPARA DE PIE EXTERIOR	Blanco	PARA Lámpara E27	60CM ALTURA	Ref
				APQ-533





APLIQUES EXTERIOR JARDIN

IP 65

PARA BOMBILLA E27



NEW!



SERIE ALUMINIO

Lámpara NO INCLUIDA

				Ref	PVPR	
LÁMPARA SUELO EXTERIOR	CIRCULAR	PARA Lámpara E27	60CM ALTURA	APQ-307	56,82€	↓
LÁMPARA SUELO EXTERIOR	CUADRADO	PARA Lámpara E27	60CM ALTURA	APQ-308	56,82€	↓



60 cm

CIRCULAR CUADRADO

NEW!



PARA DICROICA GU10



SERIE ALUMINIO

Lámpara NO INCLUIDA

				Ref	PVPR
LÁMPARA SUELO EXTERIOR	Negro	PARA Lámpara GU10	60CM ALTURA	APQ-302	56,70€
LÁMPARA SUELO EXTERIOR	Blanco	PARA Lámpara GU10	60CM ALTURA	APQ-536	



60 cm

* Según la nueva normativa ERP ha habido un cambio en la medición de Lúmenes y vatios, pero sigue emitiendo la misma cantidad de luz. A medida que vayan entrando los nuevos modelos con ERP se irá actualizando en catálogo y cajas de color. Puede haber variación respecto la caja del producto (comprobar en ficha técnica), todos los datos en catálogo están correctos salvo error tipográfico.



Serie picas de jardin

LED INCLUIDO



Led integrado - Incluye cable de alimentación

	K°	Ref	PVPR
FOCO PICA JARDIN	3200K	ACLED-354	9,06 €
FOCO PICA JARDIN	5000K	ACLED-355	9,06 €



MATERIAL PC

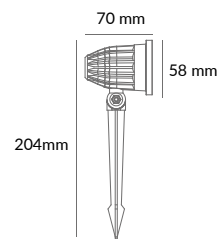

NO INCLUYEN Lámparas

Incluye cable alimentación de 1,5mts. con enchufe de seguridad.

	Ref	PVPR
Pica de jardin para PAR38 <i>Máximo 150w E27</i>	ACLED-065	23,64€
Pica de jardin para 2 x PAR38 <i>Máximo 150w 2 x E27</i>	ACLED-066	26,85€



MATERIAL PC

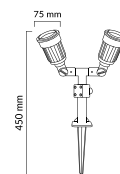

ACLED-065

ACLED-066



No incluye cable de alimentación

Pica de jardin para PAR38 NEGRO	ACLED-174	15,42€
---	-----------	--------



MATERIAL PC

DISEÑO ROBUSTO

Tierra

Pared

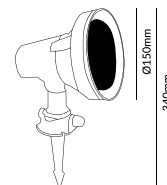
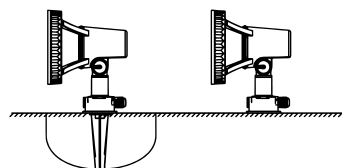

Incluye cable de alimentación

Pica de jardin para GU10 NEGRO	ACLED-173	30,54€
--	-----------	--------



SERIE ALUMINIO

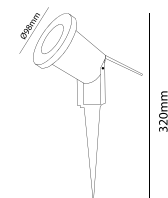

NEW!



No incluye cable de alimentación

Pica de jardin para GU10 NEGRO	ACLED-356	16,50€
--	-----------	--------



MATERIAL PLS

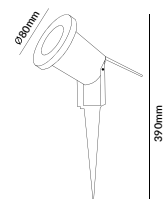

Serie foco de suelo

PARA
DICROICA GU10



FOCO EMPOTRABLE **EXTERIOR**



SERIE ALUMINIO

NEW!



-Para Dicroicas GU10-MR16 - Lámpara no incluida - Incluye portalámparas

FOCO EMPOTRABLE SUELO REDONDO	GU10	Ref	PVPR
		APQ-078	35,76€

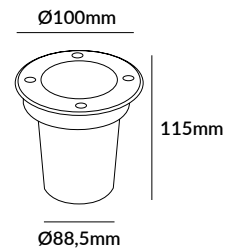

-Para Dicroicas GU10-MR16 - Lámpara no incluida - Incluye portalámparas

FOCO EMPOTRABLE SUELO CUADRADO	GU10	Ref	PVPR
		APQ-067	39,15€

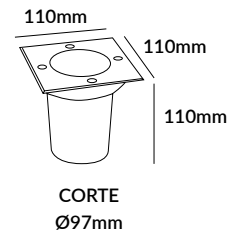





Serie Downlight

Serie Downlight Empotrado

**AHORRA ESPACIO
EN TU ALMACÉN**

**3 en 1 TRES TIPOS DE LUZ
EN LA MISMA LUMINARIA**

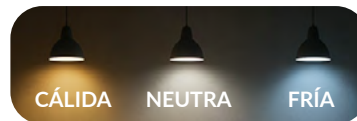

		K°	Ref	PVPR
DOWNLIGHT EMPOTRAR CIRCULAR	6W 400Lm	3CCT	DOW-467	11,70 €
DOWNLIGHT EMPOTRAR CIRCULAR	12W 800Lm	3CCT	DOW-468	17,25 €
DOWNLIGHT EMPOTRAR CIRCULAR	18W 1400Lm	3CCT	DOW-469	20,85 €

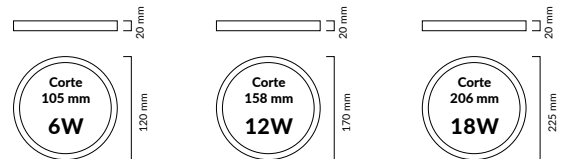

		K°	Ref	PVPR
DOWNLIGHT 3CCT	CIRCULAR BLANCO Empotrado 6w	3CCT	DOW-315	10,17€
DOWNLIGHT 3CCT	CIRCULAR BLANCO Empotrado 12w	3CCT	DOW-316	16,23€
DOWNLIGHT 3CCT	CIRCULAR BLANCO Empotrado 18w	3CCT	DOW-317	19,38€
DOWNLIGHT 3CCT	CIRCULAR BLANCO Empotrado 24w	3CCT	DOW-390	24,75€

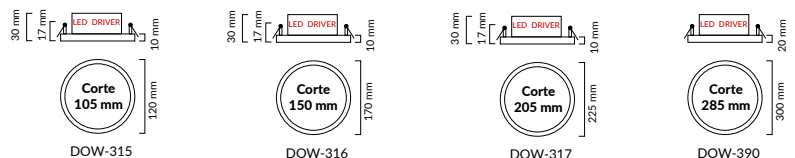

DOWNLIGHT MINI BLANCO	7w	3CCT	DOW-332	11,76€
-----------------------	----	------	---------	--------

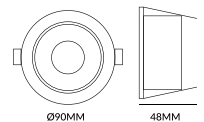



DOWNLIGHT TÉCNICO ESPECIAL CENTROS EDUCATIVOS

Gracias al **UGR<19** lo hace ideal para espacios donde hay que realizar tareas de larga duración, ya sea centros educativos, oficinas, áreas de trabajo. No causa deslumbramiento aportando un **comfort visual**.

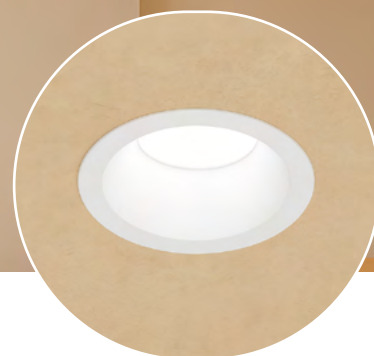

COMFORT VISUAL
UGR<19

DOWNLIGHT 3CCT SWITCH DIMMABLE

3 en 1 TRES TIPOS DE LUZ EN LA MISMA LUMINARIA

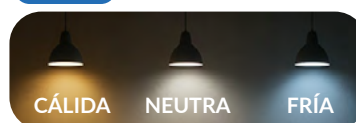

DISEÑO MODERNO



LED CHIP ALTA CALIDAD



DOWNLIGHT EMPOTRADO

K° Ref PVPR

DOWNLIGHT CIRCULAR REGULABLE TRIAC *Empotrado* 15w 3CCT DOW-458 21,66€

DOWNLIGHT CIRCULAR REGULABLE TRIAC *Empotrado* 25w 3CCT DOW-323 31,50€

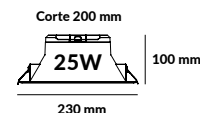
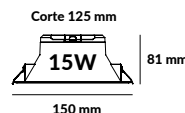

Downlight dimmable con las pastillas:



tuya

CONTR-063 - 300w -
Regulador para varios pulsadores 60,66€



CONTR-022 - 360w -
Regulador para varios pulsadores 52,62€

* Según la nueva normativa ERP ha habido un cambio en la medición de Lúmenes y vatios, pero sigue emitiendo la misma cantidad de luz. A medida que vayan entrando los nuevos modelos con ERP se irá actualizando en catálogo y cajas de color. Puede haber variación respecto a la caja del producto (comprobar en ficha técnica), todos los datos en catálogo están correctos salvo error tipográfico.

Serie Downlight - Estanco IP65

DOWNLIGHTS EXTERIOR IP 65



		K°	Ref	PVPR
DOWNLIGHT EMPOTRABLE CIRCULAR	15W 1200Lm	3200K	 DOW-459	11,04 €
DOWNLIGHT EMPOTRABLE CIRCULAR	15W 1200Lm	4200K	 DOW-460	11,04 €









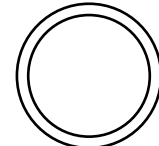

Ø170mm

Corte 150mm

		K°	Ref	PVPR
DOWNLIGHT EMPOTRABLE CIRCULAR	20W 2000Lm	3200K	 DOW-461	14,70 €
DOWNLIGHT EMPOTRABLE CIRCULAR	20W 2000Lm	4200K	 DOW-462	14,70 €









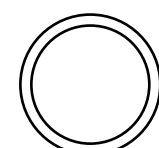

Ø225mm

Corte 200mm

ACCESORIO SUPERFICIE PVPR

ACLED-465 ACCESORIO DE MONTAJE SUPERFICIE PARA DOW-459/460	2,58 €
--	--------

ACLED-466 ACCESORIO DE MONTAJE SUPERFICIE PARA DOW-461/462/402	3,60 €
--	--------

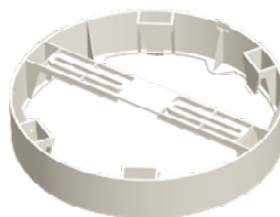



DOWNLIGHTS EXTERIOR



3 en 1 TRES TIPOS DE LUZ
EN LA MISMA LUMINARIA

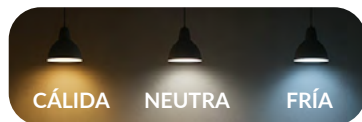

		K°	Ref	PVPR
DOWNLIGHT EMPOTRABLE CIRCULAR	20W 2000Lm	3CCT	DOW-402	16,56 €

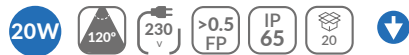
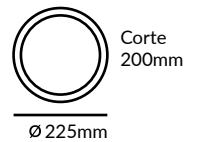

* Según la nueva normativa ERP ha habido un cambio en la medición de Lúmenes y vatios, pero sigue emitiendo la misma cantidad de luz. A medida que vayan entrando los nuevos modelos con ERP se irá actualizando en catálogo y cajas de color. Puede haber variación respecto la caja del producto (comprobar en ficha técnica), todos los datos en catálogo están correctos salvo error tipográfico.



LED DRIVER
ALTA CALIDAD

ALTA
LUMINOSIDAD

Downlight SLIM BACK-LIGHT

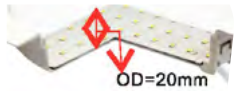

Downlight con sistema **BACK-LIGHT**
NO PRODUCE DESLUMBRAMIENTO

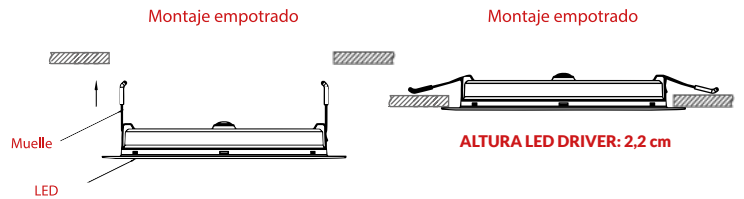

SE VENDE EN EMBALAJES COMPLETOS 20

	K°	Ref	PVPR	
DOWNLIGHT PLANO SUPER-SLIM BACK-LIGHT	8W 720Lm	3200K	● DOW-440	6,06€
DOWNLIGHT PLANO SUPER-SLIM BACK-LIGHT	8W 720Lm	4200K	● DOW-441	6,06€
DOWNLIGHT PLANO SUPER-SLIM BACK-LIGHT	8W 720Lm	5000K	● DOW-442	6,06€
DOWNLIGHT PLANO SUPER-SLIM BACK-LIGHT	12W 1080Lm	3200K	● DOW-443	7,56€
DOWNLIGHT PLANO SUPER-SLIM BACK-LIGHT	12W 1080Lm	4200K	● DOW-444	7,56€
DOWNLIGHT PLANO SUPER-SLIM BACK-LIGHT	12W 1080Lm	5000K	● DOW-445	7,56€
DOWNLIGHT PLANO SUPER-SLIM BACK-LIGHT	15W 1400Lm	3200K	● DOW-446	9,06€
DOWNLIGHT PLANO SUPER-SLIM BACK-LIGHT	15W 1400Lm	4200K	● DOW-447	9,06€
DOWNLIGHT PLANO SUPER-SLIM BACK-LIGHT	15W 1400Lm	5000K	● DOW-448	9,06€
DOWNLIGHT PLANO SUPER-SLIM BACK-LIGHT	20W 2000Lm	3200K	● DOW-457	13,62€
DOWNLIGHT PLANO SUPER-SLIM BACK-LIGHT	20W 2000Lm	4200K	● DOW-449	13,62€
DOWNLIGHT PLANO SUPER-SLIM BACK-LIGHT	20W 2000Lm	5000K	● DOW-450	13,62€

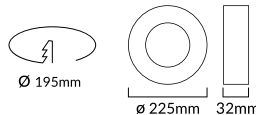
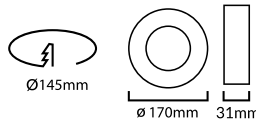
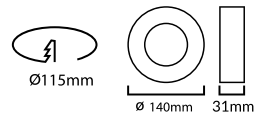
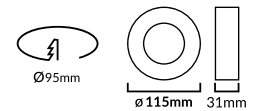

3 en 1 TRES TIPOS DE LUZ
EN LA MISMA LUMINARIA

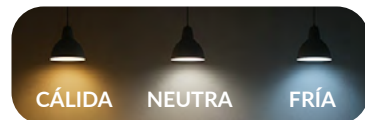

NEW! Downlight SLIM BACK-LIGHT 3CCT

DOWNLIGHT PLANO SUPER-SLIM BACK-LIGHT	12W 1080Lm	3CCT	● DOW-400	8,61€
DOWNLIGHT PLANO SUPER-SLIM BACK-LIGHT	20W 2000Lm	3CCT	● DOW-401	15,18€

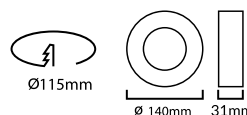

DOW-400

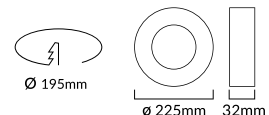

DOW-401

Downlight **ULTRA-FINO**



Ideal para espacios reducidos



ULTRA FINO 1,3cm

3 en 1 TRES TIPOS DE LUZ EN LA MISMA LUMINARIA

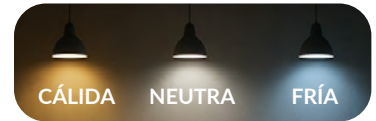

DOWNLIGHT ULTRA-FINO 6W 600Lm



K° Ref PVPR
3CCT DOW-397 9,75€

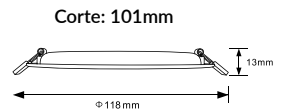

DOWNLIGHT ULTRA-FINO 12W 1200Lm



K° Ref PVPR
3CCT DOW-398 12,30€

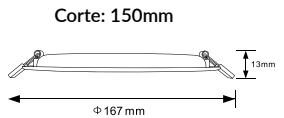

DOWNLIGHT ULTRA-FINO 24W 2400Lm

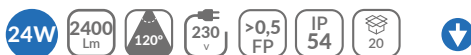

K° Ref PVPR
3CCT DOW-399 18,84€

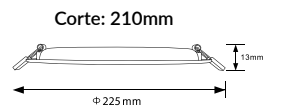

SE ADAPTA A TECHOS BAJOS

LED DRIVER

3CCT + (Auto Interruptor pared)



Switch led driver

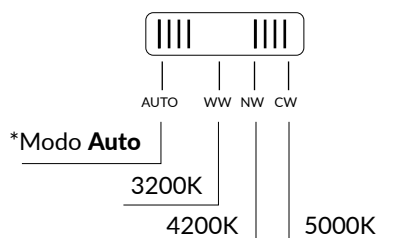

Cambio de color desde el Switch en el led driver

*Modo **Auto**:

Cada pulsación corta desde el interruptor cambia de color.

Si esperas unos 40 segundos y vuelves a pulsar se mantiene el color.

* Según la nueva normativa ERP ha habido un cambio en la medición de Lúmenes y vatios, pero sigue emitiendo la misma cantidad de luz. A medida que vayan entrando los nuevos modelos con ERP se irá actualizando en catálogo y cajas de color. Puede haber variación respecto a la caja del producto (comprobar en ficha técnica), todos los datos en catálogo están correctos salvo error tipográfico.



			K°	Ref	PVPR
DOWNLIGHT ELYOS	CIRCULAR CROMO MATE	Empotrado 6w	3200K	DOW-069	13,71€
DOWNLIGHT SAMSUNG	CIRCULAR CROMO MATE	Empotrado 6w	4200K	DOW-288	13,71€
DOWNLIGHT SAMSUNG	CIRCULAR CROMO MATE	Empotrado 6w	5000K	DOW-289	13,71€
DOWNLIGHT SAMSUNG	CIRCULAR BLANCO	Empotrado 6w	3200K	DOW-266	8,94€
DOWNLIGHT SAMSUNG	CIRCULAR BLANCO	Empotrado 6w	4200K	DOW-218	8,94€
DOWNLIGHT SAMSUNG	CIRCULAR BLANCO	Empotrado 6w	5000K	DOW-219	8,94€
DOWNLIGHT ELYOS	CIRCULAR ALU.BRUSH.	Empotrado 6w	3200K	DOW-177	13,71€
DOWNLIGHT SAMSUNG	CIRCULAR ALU.BRUSH.	Empotrado 6w	4200K	DOW-286	13,71€
DOWNLIGHT SAMSUNG	CIRCULAR ALU.BRUSH.	Empotrado 6w	5000K	DOW-287	13,71€
DOWNLIGHT ELYOS	CUADRADO BLANCO	Empotrado 6w	3200K	DOW-076	11,22€
DOWNLIGHT SAMSUNG	CUADRADO BLANCO	Empotrado 6w	4200K	DOW-262	11,22€
DOWNLIGHT SAMSUNG	CUADRADO BLANCO	Empotrado 6w	5000K	DOW-263	11,22€
DOWNLIGHT ELYOS	CUADRADO CROMO MATE	Empotrado 6w	3200K	DOW-079	12,66€
DOWNLIGHT ELYOS	CUADRADO CROMO MATE	Empotrado 6w	4200K	DOW-080	12,66€
DOWNLIGHT ELYOS	CUADRADO CROMO MATE	Empotrado 6w	5000K	DOW-081	12,66€
DOWNLIGHT SAMSUNG	CUADRADO ALU.BRUSH.	Empotrado 6w	3200K	DOW-312	15,48€
DOWNLIGHT ELYOS	CUADRADO ALU.BRUSH.	Empotrado 6w	4200K	DOW-181	15,39€
DOWNLIGHT ELYOS	CUADRADO ALU.BRUSH.	Empotrado 6w	5000K	DOW-182	15,39€

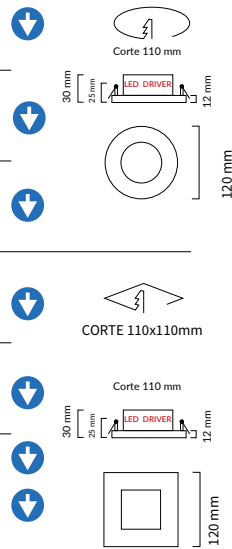

6w 470 Lm 120° 230 v >0,9 DF IP 20 40 30 DOW-266 DOW-218 DOW-219



DOWNLIGHT ELYOS	CIRCULAR CROMO MATE	Empotrado 12w	3200K	DOW-063	18,84€
DOWNLIGHT ELYOS	CIRCULAR CROMO MATE	Empotrado 12w	4200K	DOW-064	18,84€
DOWNLIGHT ELYOS	CIRCULAR CROMO MATE	Empotrado 12w	5000K	DOW-065	18,84€
DOWNLIGHT SAMSUNG	CIRCULAR BLANCO	Empotrado 12w	3200K	DOW-270	14,55€
DOWNLIGHT SAMSUNG	CIRCULAR BLANCO	Empotrado 12w	4200K	DOW-220	14,55€
DOWNLIGHT SAMSUNG	CIRCULAR BLANCO	Empotrado 12w	5000K	DOW-221	14,55€
DOWNLIGHT ELYOS	CIRCULAR ALU.BRUSH.	Empotrado 12w	3200K	DOW-171	18,93€
DOWNLIGHT SAMSUNG	CIRCULAR ALU.BRUSH.	Empotrado 12w	4200K	DOW-294	21,93€
DOWNLIGHT SAMSUNG	CIRCULAR ALU.BRUSH.	Empotrado 12w	5000K	DOW-295	21,93€
DOWNLIGHT ELYOS	CUADRADO BLANCO	Empotrado 12w	3200K	DOW-082	16,74€
NEW DOWNLIGHT SAMSUNG	CUADRADO BLANCO	Empotrado 12w	4200K	DOW-299	16,74€
DOWNLIGHT SAMSUNG	CUADRADO BLANCO	Empotrado 12w	5000K	DOW-264	16,74€
DOWNLIGHT ELYOS	CUADRADO CROMO MATE	Empotrado 12w	3200K	DOW-085	17,07€
DOWNLIGHT ELYOS	CUADRADO CROMO MATE	Empotrado 12w	4200K	DOW-086	17,07€
DOWNLIGHT ELYOS	CUADRADO CROMO MATE	Empotrado 12w	5000K	DOW-087	17,07€
DOWNLIGHT ELYOS	CUADRADO ALU.BRUSH.	Empotrado 12w	3200K	DOW-174	23,76€
DOWNLIGHT ELYOS	CUADRADO ALU.BRUSH.	Empotrado 12w	4200K	DOW-175	23,76€
DOWNLIGHT ELYOS	CUADRADO ALU.BRUSH.	Empotrado 12w	5000K	DOW-176	23,76€

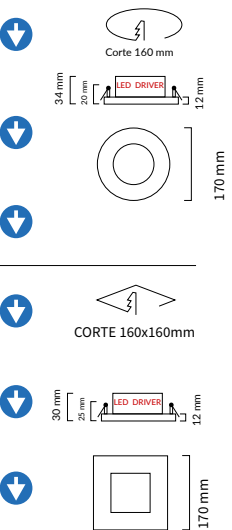

12w 860 Lm 120° 230 v >0,9 FP IP 20 30



DOWNLIGHT LITE	CIRCULAR BLANCO	Empotrado 18w	4200K	DOW-158	13,14€
DOWNLIGHT LITE	CIRCULAR BLANCO	Empotrado 18w	5000K	DOW-157	13,14€

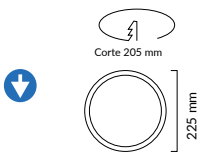

DOWNLIGHT SAMSUNG	CIRCULAR BLANCO	Empotrado 18w	3200K	DOW-272	17,10€
DOWNLIGHT SAMSUNG	CIRCULAR BLANCO	Empotrado 18w	4200K	DOW-222	17,10€
DOWNLIGHT SAMSUNG	CIRCULAR BLANCO	Empotrado 18w	5000K	DOW-223	17,10€
DOWNLIGHT ELYOS	CIRCULAR CROMO MATE	Empotrado 18w	3200K	DOW-099	23,94€
DOWNLIGHT SAMSUNG	CIRCULAR CROMO MATE	Empotrado 18w	4200K	DOW-277	26,01€
DOWNLIGHT SAMSUNG	CIRCULAR CROMO MATE	Empotrado 18w	5000K	DOW-275	26,01€
DOWNLIGHT SAMSUNG	CIRCULAR ALU. BRUSH.	Empotrado 18w	3200K	DOW-165	26,01€
DOWNLIGHT SAMSUNG	CIRCULAR ALU. BRUSH.	Empotrado 18w	4200K	DOW-278	26,01€
DOWNLIGHT SAMSUNG	CIRCULAR ALU. BRUSH.	Empotrado 18w	5000K	DOW-276	26,01€

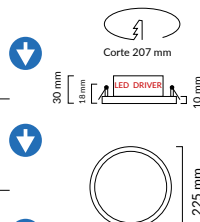

18w 1400 Lm 120° 230 v >0,9 FP IP 20 20



				K°	Ref	PVPR
DOWNLIGHT SAMSUNG	CUADRADO BLANCO	<i>Empotrado 18w</i>	3200K	●	DOW-225	26,61€
DOWNLIGHT SAMSUNG	CUADRADO BLANCO	<i>Empotrado 18w</i>	4200K	●	DOW-228	26,61€
DOWNLIGHT SAMSUNG	CUADRADO BLANCO	<i>Empotrado 18w</i>	5000K	●	DOW-229	26,61€
DOWNLIGHT ELYOS	CUADRADO CROMO MATE	<i>Empotrado 18w</i>	3200K	●	DOW-137	24,72€
DOWNLIGHT SAMSUNG	CUADRADO CROMO MATE	<i>Empotrado 18w</i>	4200K	●	DOW-377	28,20€
DOWNLIGHT SAMSUNG	CUADRADO CROMO MATE	<i>Empotrado 18w</i>	5000K	●	DOW-304	28,20€
DOWNLIGHT ELYOS	CUADRADO ALU. BRUSH.	<i>Empotrado 18w</i>	3200K	●	DOW-168	24,72€
DOWNLIGHT ELYOS	CUADRADO ALU. BRUSH.	<i>Empotrado 18w</i>	4200K	●	DOW-169	24,72€
NEW	DOWNLIGHT SAMSUNG	CUADRADO ALU. BRUSH.	<i>Empotrado 18w</i>	3CCT	DOW-394	24,72€

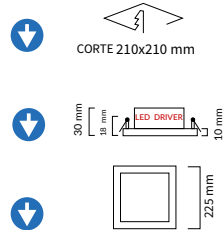

DOWNLIGHT SAMSUNG	CIRCULAR CROMO MATE	<i>Empotrado 24w</i>	4200K	●	DOW-307	30,93€	CORTE 206MM
DOWNLIGHT SAMSUNG	CIRCULAR CROMO MATE	<i>Empotrado 24w</i>	5000K	●	DOW-308	30,93€	CORTE 206MM
DOWNLIGHT SAMSUNG	CIRCULAR BLANCO	<i>Empotrado 25w</i>	3200K	●	DOW-090	22,50€	CORTE 208MM
DOWNLIGHT SAMSUNG	CIRCULAR BLANCO	<i>Empotrado 24w</i>	4200K	●	DOW-305	22,50€	CORTE 206MM
DOWNLIGHT SAMSUNG	CIRCULAR BLANCO	<i>Empotrado 24w</i>	5000K	●	DOW-306	22,50€	CORTE 206MM
DOWNLIGHT SAMSUNG	CUADRADO BLANCO	<i>Empotrado 25w</i>	4200K	●	DOW-048	33,24€	CORTE 208 x 208 MM
DOWNLIGHT SAMSUNG	CUADRADO BLANCO	<i>Empotrado 25w</i>	5000K	●	DOW-049	33,24€	CORTE 208 x 208 MM
DOWNLIGHT ELYOS	CUADRADO CROMO MATE	<i>Empotrado 25w</i>	4200K	●	DOW-050	48,78€	CORTE 205 x 205 MM
DOWNLIGHT ELYOS	CUADRADO CROMO MATE	<i>Empotrado 25w</i>	5000K	●	DOW-051	48,78€	CORTE 205 x 205 MM

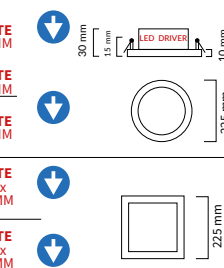

DOWNLIGHT PHOENIX	CIRCULAR BLANCO	<i>Empotrado 25w</i>	3200K	●	DOW-191	50,22€	ALTURA CON LED DRIVER 58MM
DOWNLIGHT PHOENIX	CIRCULAR BLANCO	<i>Empotrado 25w</i>	4200K	●	DOW-192	50,22€	ALTURA CON LED DRIVER 58MM
DOWNLIGHT PHOENIX	CIRCULAR BLANCO	<i>Empotrado 25w</i>	5000K	●	DOW-193	50,22€	ALTURA CON LED DRIVER 58MM

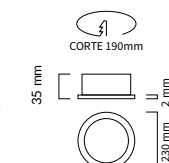

DOWNLIGHT PRF SERIES SAMSUNG	BLANCO	<i>Empotrado 30w</i>	3200K	●	DOW-216	31,65€	ALTURA CON LED DRIVER 77MM
DOWNLIGHT PRF SERIES SAMSUNG	BLANCO	<i>Empotrado 30w</i>	4200K	●	DOW-214	31,65€	ALTURA CON LED DRIVER 77MM
DOWNLIGHT PRF SERIES SAMSUNG	BLANCO	<i>Empotrado 30w</i>	5000K	●	DOW-215	31,65€	ALTURA CON LED DRIVER 77MM

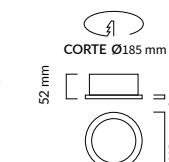

DOWNLIGHT PHOENIX	CIRCULAR BLANCO	<i>Empotrado 42w</i>	3200K	●	DOW-236	63,21€	ALTURA CON LED DRIVER 65MM
DOWNLIGHT PHOENIX	CIRCULAR BLANCO	<i>Empotrado 42w</i>	4200K	●	DOW-194	63,21€	ALTURA CON LED DRIVER 65MM
DOWNLIGHT PHOENIX	CIRCULAR BLANCO	<i>Empotrado 42w</i>	5000K	●	DOW-195	63,21€	ALTURA CON LED DRIVER 65MM

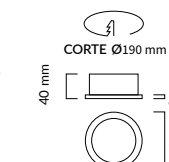

Serie Downlight Superficie

DOWNLIGHT 3CCT CON CORTE AJUSTABLE

3 en 1 TRES TIPOS DE LUZ EN LA MISMA LUMINARIA

CÁLIDA NEUTRA FRÍA



• DOWNLIGHT SUPERFICIE

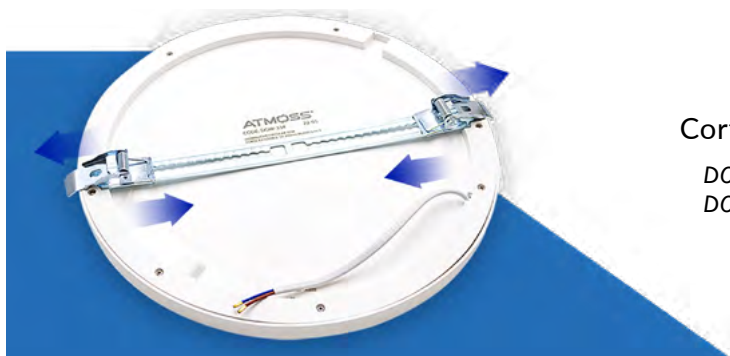

Corte Ajustable

DOW-333: 50 - 180 mm
DOW-334: 50 - 260 mm

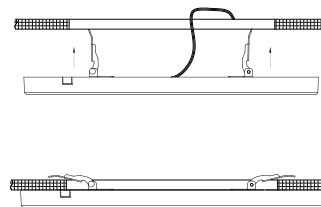

NEW PRICE!!



	K°	Ref	PVPR
DOWNLIGHT CORTE AJUSTABLE 50 - 180mm 22cm 18w 1850Lm 3CCT		DOW-333	18,81€

DOWNLIGHT CORTE AJUSTABLE 50 - 260mm 29,8cm 22w 2270Lm 3CCT		DOW-334	43,68€
--	--	---------	--------

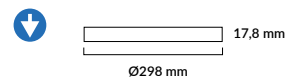
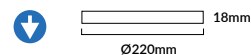



DOWNLIGHT 3CCT SUPERFICIE

3 en 1 TRES TIPOS DE LUZ
EN LA MISMA LUMINARIA

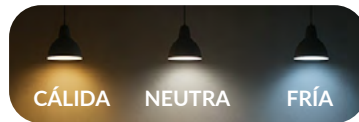

NEW!



				K°	Ref	PVPR	
DOWNLIGHT SUPERFICIE CIRCULAR	6W	400Lm	30	3CCT	DOW-463	14,16 €	↓
DOWNLIGHT SUPERFICIE CIRCULAR	12W	800Lm	20	3CCT	DOW-464	19,32 €	↓
DOWNLIGHT SUPERFICIE CIRCULAR	18W	1400Lm	20	3CCT	DOW-465	25,32 €	↓
DOWNLIGHT SUPERFICIE CIRCULAR	24W	1400Lm	20	3CCT	DOW-391	39,45 €	↓

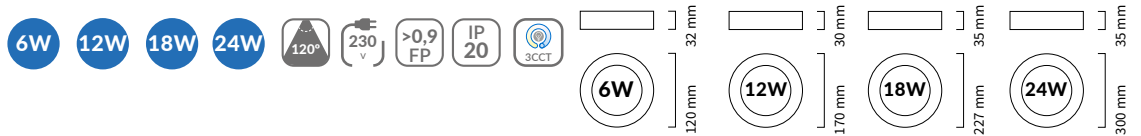

NEW!



				K°	Ref	PVPR	
DOWNLIGHT SUPERFICIE CIRCULAR	6W	400Lm	30	3CCT	DOW-473	17,94 €	
DOWNLIGHT SUPERFICIE CIRCULAR	12W	800Lm	20	3CCT	DOW-474	26,34 €	
DOWNLIGHT SUPERFICIE CIRCULAR	18W	1400Lm	20	3CCT	DOW-466	27,36 €	↓

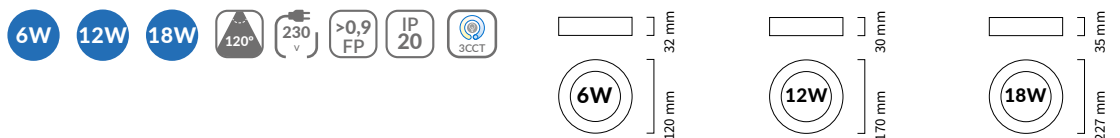

* Según la nueva normativa ERP ha habido un cambio en la medición de Lúmenes y vatios, pero sigue emitiendo la misma cantidad de luz.
A medida que vayan entrando los nuevos modelos con ERP se irá actualizando en catálogo y cajas de color.
Puede haber variación respecto la caja del producto (comprobar en ficha técnica), todos los datos en catálogo están correctos salvo error tipográfico.



· DOWNLIGHT SUPERFICIE



				K°	Ref	PVPR	
DOWNLIGHT ELYOS	CIRCULAR CROMO MATE	<i>Superficie 6w</i>	3200K	●	DOW-130	14,25€	↓
DOWNLIGHT ELYOS	CIRCULAR CROMO MATE	<i>Superficie 6w</i>	4200K	●	DOW-131	14,25€	
DOWNLIGHT ELYOS	CIRCULAR CROMO MATE	<i>Superficie 6w</i>	5000K	●	DOW-132	14,25€	
DOWNLIGHT SAMSUNG	CIRCULAR BLANCO	<i>Superficie 6w</i>	3200K	●	DOW-283	12,30€	↓
DOWNLIGHT SAMSUNG	CIRCULAR BLANCO	<i>Superficie 6w</i>	4200K	●	DOW-271	12,30€	
DOWNLIGHT SAMSUNG	CIRCULAR BLANCO	<i>Superficie 6w</i>	5000K	●	DOW-284	12,30€	
DOWNLIGHT ELYOS	CUADRADO CROMO MATE	<i>Superficie 6w</i>	3200K	●	DOW-140	15,12€	↓
DOWNLIGHT ELYOS	CUADRADO CROMO MATE	<i>Superficie 6w</i>	4200K	●	DOW-141	15,12€	
DOWNLIGHT ELYOS	CUADRADO CROMO MATE	<i>Superficie 6w</i>	5000K	●	DOW-142	15,12€	
DOWNLIGHT ELYOS	CUADRADO BLANCO	<i>Superficie 6w</i>	3200K	●	DOW-103	12,78€	↓
DOWNLIGHT ELYOS	CUADRADO BLANCO	<i>Superficie 6w</i>	4200K	●	DOW-104	12,78€	
DOWNLIGHT ELYOS	CUADRADO BLANCO	<i>Superficie 6w</i>	5000K	●	DOW-105	12,78€	

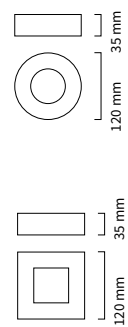

DOWNLIGHT ELYOS	CIRCULAR CROMO MATE	<i>Superficie 12w</i>	3200K	●	DOW-133	18,75€	↓
DOWNLIGHT SAMSUNG	CIRCULAR CROMO MATE	<i>Superficie 12w</i>	4200K	●	DOW-300	18,75€	
DOWNLIGHT ELYOS	CIRCULAR CROMO MATE	<i>Superficie 12w</i>	5000K	●	DOW-135	18,75€	
DOWNLIGHT SAMSUNG	CIRCULAR BLANCO	<i>Superficie 12w</i>	3200K	●	DOW-269	17,25€	↓
DOWNLIGHT SAMSUNG	CIRCULAR BLANCO	<i>Superficie 12w</i>	4200K	●	DOW-230	17,25€	
DOWNLIGHT SAMSUNG	CIRCULAR BLANCO	<i>Superficie 12w</i>	5000K	●	DOW-231	17,25€	
DOWNLIGHT ELYOS	CUADRADO CROMO MATE	<i>Superficie 12w</i>	3200K	●	DOW-143	21,39€	↓
DOWNLIGHT ELYOS	CUADRADO CROMO MATE	<i>Superficie 12w</i>	4200K	●	DOW-144	21,39€	
DOWNLIGHT ELYOS	CUADRADO CROMO MATE	<i>Superficie 12w</i>	5000K	●	DOW-145	21,39€	
DOWNLIGHT ELYOS	CUADRADO BLANCO	<i>Superficie 12w</i>	3200K	●	DOW-109	16,47€	↓
DOWNLIGHT ELYOS	CUADRADO BLANCO	<i>Superficie 12w</i>	4200K	●	DOW-110	16,47€	
DOWNLIGHT ELYOS	CUADRADO BLANCO	<i>Superficie 12w</i>	5000K	●	DOW-111	16,47€	

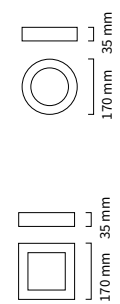

				K°	Ref	PVPR	
DOWNLIGHT ELYOS	CIRCULAR ALUM. BRUSH.	<i>Superficie 18w</i>	3200K	●	DOW-162	32,64€	↓
DOWNLIGHT ELYOS	CIRCULAR ALUM. BRUSH.	<i>Superficie 18w</i>	4200K	●	DOW-163	32,64€	
DOWNLIGHT ELYOS	CIRCULAR ALUM. BRUSH.	<i>Superficie 18w</i>	5000K	●	DOW-164	32,64€	
DOWNLIGHT SAMSUNG	CUADRADO BLANCO	<i>Superficie 18w</i>	3200K	●	DOW-265	28,26€	↓
DOWNLIGHT SAMSUNG	CUADRADO BLANCO	<i>Superficie 18w</i>	4200K	●	DOW-267	28,26€	
DOWNLIGHT SAMSUNG	CUADRADO BLANCO	<i>Superficie 18w</i>	5000K	●	DOW-268	28,26€	
DOWNLIGHT ELYOS	CUADRADO CROMO MATE	<i>Superficie 18w</i>	3200K	●	DOW-187	30,30€	↓
DOWNLIGHT ELYOS	CUADRADO CROMO MATE	<i>Superficie 18w</i>	4200K	●	DOW-046	30,30€	
DOWNLIGHT ELYOS	CUADRADO CROMO MATE	<i>Superficie 18w</i>	5000K	●	DOW-047	30,30€	
DOWNLIGHT ELYOS	CUADRADO ALUM. BRUSH.	<i>Superficie 18w</i>	3200K	●	DOW-188	35,94€	↓
DOWNLIGHT ELYOS	CUADRADO ALUM. BRUSH.	<i>Superficie 18w</i>	4200K	●	DOW-189	35,94€	
DOWNLIGHT ELYOS	CUADRADO ALUM. BRUSH.	<i>Superficie 18w</i>	5000K	●	DOW-190	35,94€	
DOWNLIGHT ELYOS	CIRCULAR CROMO MATE	<i>Superficie 18w</i>	4200K	●	DOW-034	30,00€	↓
DOWNLIGHT ELYOS	CIRCULAR CROMO MATE	<i>Superficie 18w</i>	5000K	●	DOW-035	30,00€	
DOWNLIGHT SAMSUNG	CIRCULAR BLANCO	<i>Superficie 18w</i>	3200K	●	DOW-273	23,25€	↓
DOWNLIGHT SAMSUNG	CIRCULAR BLANCO	<i>Superficie 18w</i>	4200K	●	DOW-226	23,25€	
DOWNLIGHT SAMSUNG	CIRCULAR BLANCO	<i>Superficie 18w</i>	5000K	●	DOW-227	23,25€	





DOWNLIGHT SAMSUNG CIRCULAR BLANCO	Superficie 24w	4200K	DOW-232	34,35€	↓
DOWNLIGHT SAMSUNG CIRCULAR BLANCO	Superficie 24w	5000K	DOW-233	34,35€	↓
DOWNLIGHT SAMSUNG CUADRADO BLANCO	Superficie 24w	4200K	DOW-234	35,79€	↓
DOWNLIGHT SAMSUNG CUADRADO BLANCO	Superficie 24w	5000K	DOW-235	35,79€	↓

DOW-232 DOW-233
 DOW-234 DOW-235

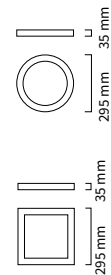

NEW DOWNLIGHT SAMSUNG CIRCULAR BLANCO	Superficie 25w	3200K	DOW-350	40,44€	↓
DOWNLIGHT SAMSUNG CIRCULAR BLANCO	Superficie 25w	4200K	DOW-309	40,44€	↓
DOWNLIGHT ELYOS CUADRADO BLANCO	Superficie 25w	5000K	DOW-094	40,44€	↓
DOWNLIGHT ELYOS CIRCULAR CROMO MATE	Superficie 25w	4200K	DOW-138	49,29€	↓
DOWNLIGHT ELYOS CIRCULAR CROMO MATE	Superficie 25w	5000K	DOW-139	49,29€	↓

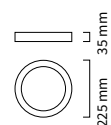

Serie Downlight - WIFI RGB - 3CCT

Downlight **domótico**



3 en 1 TRES TIPOS DE LUZ
EN LA MISMA LUMINARIA

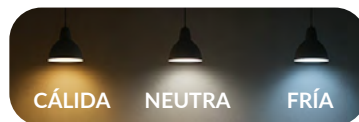

2 MODOS DE CONTROL WIFI + CONTROLADOR RF 2.4Ghz



COMPATIBLE CON APP **tuya**

Incluye mando a distancia

DESCARGAR FICHA TÉCNICA
CON VIDEO VINCULACIÓN



	K°	Ref	PVPR
DOWNLIGHT CIRCULAR PLANO	RGB + 3CCT WiFi	<i>Empotrado 18w</i>	75,90€
DOWNLIGHT CIRCULAR SUPERFICIE	RGB + 3CCT WiFi	<i>Superficie 18w</i>	75,90€

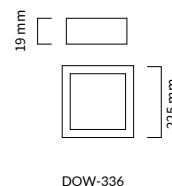
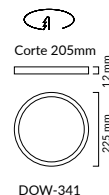

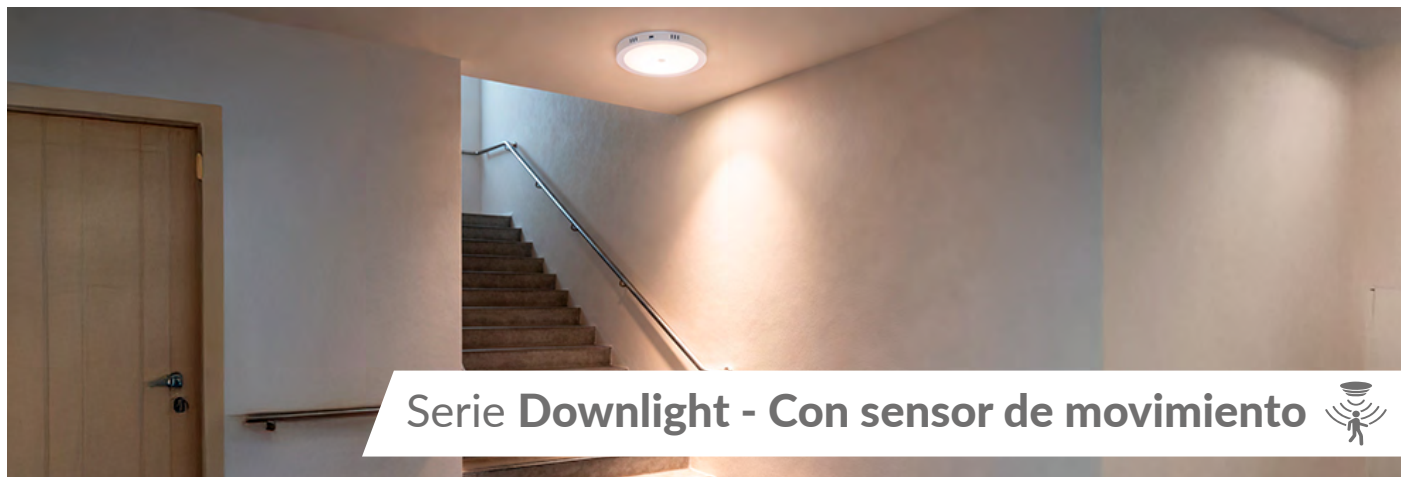

NEW!



		K°	Ref	PVPR
DOWNLIGHT SENSOR EMPOTRADO CIRCULAR	Blanco 18w	3CCT	DOW-392	26,94€
DOWNLIGHT SENSOR SUPERFICIE CIRCULAR	Blanco 18w	3CCT	DOW-393	36,60€

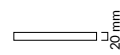

3 en 1 TRES TIPOS DE LUZ EN LA MISMA LUMINARIA

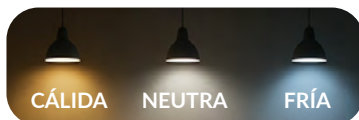

Switch **3CCT**



		K°	Ref	PVPR
DOWNLIGHT SENSOR SUPERFICIE REDONDO	Blanco 18w	3CCT	DOW-472	37,35€

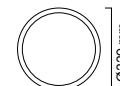
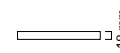

KOREAN CHIP
SMD



		K°	Ref	PVPR
DOWNLIGHT SENSOR SUPERFICIE CIRCULAR	Blanco 21w	3200K	DOW-237	34,32€
DOWNLIGHT SENSOR SUPERFICIE CIRCULAR	Blanco 21w	4200K	DOW-238	34,32€
DOWNLIGHT SENSOR SUPERFICIE CIRCULAR	Blanco 21w	5000K	DOW-239	34,32€
DOWNLIGHT SENSOR SUPERFICIE CUADRADO	Blanco 21w	4200K	DOW-280	34,32€
DOWNLIGHT SENSOR SUPERFICIE CUADRADO	Blanco 21w	5000K	DOW-281	34,32€

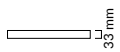

* Según la nueva normativa ERP ha habido un cambio en la medición de Lúmenes y vatios, pero sigue emitiendo la misma cantidad de luz. A medida que vayan entrando los nuevos modelos con ERP se irá actualizando en catálogo y cajas de color. Puede haber variación respecto la caja del producto (comprobar en ficha técnica), todos los datos en catálogo están correctos salvo error tipográfico.



FÁCIL
INSTALACIÓN

Carga por
USB



Batería 4000mAh
RECARGABLE CARGA USB

MODO DE CONTROL
CONTROLADOR RF 2.4Ghz

		K°	Ref	PVPR
DOWNLIGHT CON BATERIA	Blanco	3 CCT	DOW-439	38,70€

250
Lm

IP
20

SENSOR PIR
DE MOVIMIENTO





Serie Plafones

PLAFÓN
EXTERIOR



3POTENCIAS
18w/24w/30w

3 en 1 TRES TIPOS DE LUZ
EN LA MISMA LUMINARIA

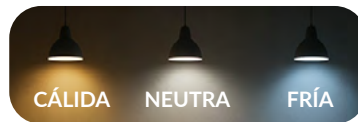

				K°	Ref	PVPR
PLAFÓN SUPERFICIE	Blanco	IP65	18-24-30w	3CCT	DOW-470	41,85€
PLAFÓN SUPERFICIE	Negro	IP65	18-24-30w	3CCT	DOW-471	41,85€

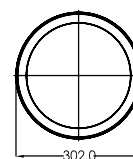

* Según la nueva normativa ERP ha habido un cambio en la medición de Lúmenes y vatios, pero sigue emitiendo la misma cantidad de luz. A medida que vayan entrando los nuevos modelos con ERP se irá actualizando en catálogo y cajas de color. Puede haber variación respecto la caja del producto (comprobar en ficha técnica), todos los datos en catálogo están correctos salvo error tipográfico.

RETROILUMINADO

Plafón led con anillo intercambiable

3 en 1 TRES TIPOS DE LUZ
EN LA MISMA LUMINARIA

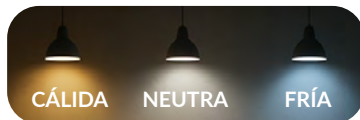

CÁLIDA

NEUTRA

FRÍA



Switch
3CCT



			K°	Ref	PVPR
PLAFON LED CIRCULAR	18w - 1850Lm	ANILLO INTERCAMBIABLE	3CCT	DOW-480	26,85€
PLAFON LED CIRCULAR	24w - 2500Lm	ANILLO INTERCAMBIABLE	3CCT	DOW-481	29,97€
PLAFON LED CIRCULAR	36w - 3830Lm	ANILLO INTERCAMBIABLE	3CCT	DOW-482	39,96€

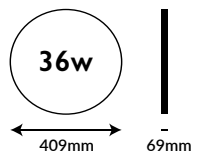
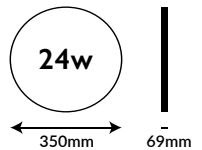
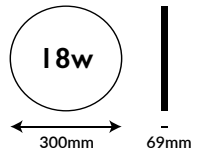

ARO INTERCAMBIABLE



Ref	PVPR
ACLED-522 18W - ANILLO BLANCO	4,02€
ACLED-523 18W - ANILLO NEGRO	4,02€
ACLED-524 18W - ANILLO MADERA	4,86€
ACLED-525 24W - ANILLO BLANCO	5,82€
ACLED-526 24W - ANILLO NEGRO	5,82€
ACLED-527 24W - ANILLO MADERA	6,48€
ACLED-528 36W - ANILLO BLANCO	7,68€
ACLED-529 36W - ANILLO NEGRO	7,68€
ACLED-530 36W - ANILLO MADERA	7,68€

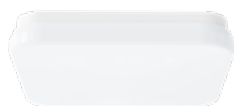

			K°	Ref	PVPR
PLAFON LED CUADRADO	18w - 1850Lm	ANILLO INTERCAMBIABLE	3CCT	DOW-454	34,20€
PLAFON LED CUADRADO	24w - 2500Lm	ANILLO INTERCAMBIABLE	3CCT	DOW-455	36,30€
PLAFON LED CUADRADO	36w - 3830Lm	ANILLO INTERCAMBIABLE	3CCT	DOW-456	57,60€

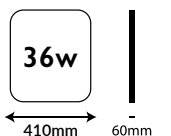
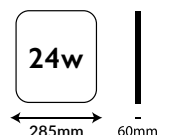
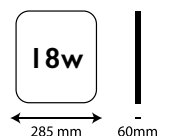

ARO INTERCAMBIABLE



Ref	PVPR
ACLED-384 18W - ANILLO BLANCO	4,14€
ACLED-385 18W - ANILLO NEGRO	4,14€
ACLED-386 18W - ANILLO MADERA	5,10€
ACLED-387 24W - ANILLO BLANCO	6,12€
ACLED-388 24W - ANILLO NEGRO	6,12€
ACLED-389 24W - ANILLO MADERA	6,90€
ACLED-390 36W - ANILLO BLANCO	7,68€
ACLED-391 36W - ANILLO NEGRO	7,68€
ACLED-392 36W - ANILLO MADERA	8,04€



RETROILUMINADO

PLAFÓN 3CCT SUPERFICIE RETROILUMINADO

3 en 1 TRES TIPOS DE LUZ EN LA MISMA LUMINARIA

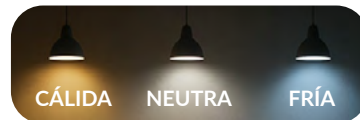

			K°	Ref	PVPR
PLAFÓN REDONDO	BLANCO RETROILUMINADO	18W	3CCT	DOW-354	36,90€
PLAFÓN REDONDO	BLANCO RETROILUMINADO	24W	3CCT	DOW-355	54,42€

18w 24w 1800 Lm 2400 Lm 120° 230 v >0,5 FP IP 40 20

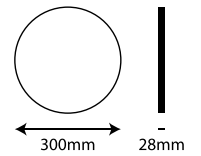

			K°	Ref	PVPR
PLAFÓN CUADRADO	BLANCO RETROILUMINADO	18W	3CCT	DOW-356	38,34€
PLAFÓN CUADRADO	BLANCO RETROILUMINADO	24W	3CCT	DOW-357	56,22€

18w 24w 1800 Lm 2400 Lm 120° 230 v >0,5 FP IP 40 20

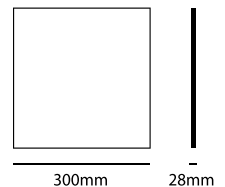

* Según la nueva normativa ERP ha habido un cambio en la medición de Lúmenes y vatios, pero sigue emitiendo la misma cantidad de luz. A medida que vayan entrando los nuevos modelos con ERP se irá actualizando en catálogo y cajas de color. Puede haber variación respecto la caja del producto (comprobar en ficha técnica), todos los datos en catálogo están correctos salvo error tipográfico.



3 en 1 TRES TIPOS DE LUZ EN LA MISMA LUMINARIA

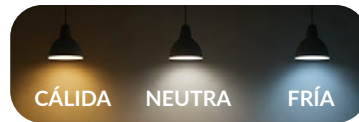

DOWNLIGHT PLAFÓN LED 3CCT



PLAFÓN LED CIRCULAR 3CCT **GRIS 20w** DOW-279 47,58€

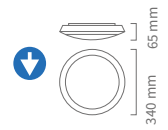

PLAFÓN LED CIRCULAR **1260 lm - 18w** 3CCT DOW-240 34,23€

PLAFÓN LED CIRCULAR **1680 lm - 24w** 3CCT DOW-241 41,58€

PLAFÓN LED CIRCULAR **2520 lm - 36w** 3CCT DOW-242 51,60€



PLAFÓN LED CIRCULAR DIAMOND **1260 lm - 18w** 3CCT DOW-243 35,61€

PLAFÓN LED CIRCULAR DIAMOND **1680 lm - 24w** 3CCT DOW-244 42,99€

PLAFÓN LED CIRCULAR DIAMOND **2520 lm - 36w** 3CCT DOW-245 78,03€

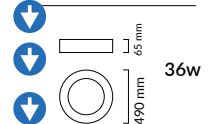
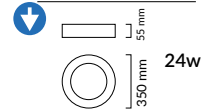

PLAFÓN LED CUADRADO **1260 lm - 18w** 3CCT DOW-246 41,85€

PLAFÓN LED CUADRADO **1680 lm - 24w** 3CCT DOW-247 47,85€

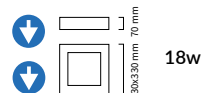

PLAFÓN LED CUADRADO DIAMOND **1260 lm - 18w** 3CCT DOW-249 47,01€

PLAFÓN LED CUADRADO DIAMOND **1680 lm - 24w** 3CCT DOW-250 56,16€

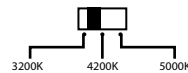
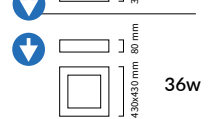
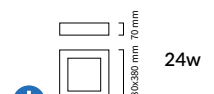

SWITCH 3CCT

PLAFON CON SENSOR DE MOVIMIENTO HF

DOWNLIGHT PLAFÓN



2-2000lux - Máx. 2x20W - Distancia radio 2-10mts - 8seg-12min

PLAFÓN PARA LÁMPARA LED SENSOR HF 2 x E27 **2 x 20w** DOW-095 83,28€

2x 20w

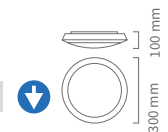

Serie Plafones - Con sensor de movimiento



Carcasa vidrio

USOS: PASILLOS, ZONAS COMUNES,...

DETECTOR DE MOVIMIENTO INFRARROJO

ESPECIAL ESCALERAS

2x CASQUILLO E27

Añade la **BLED-270**
Y haz el plafón con sistema de emergencia

2 CASQUILLO E27
Para Lámpara (NO INCLUIDA)

PLAFÓN LED SENSOR INFRARROJO



DOW-351 29,85€



- Luz ambiental: <3-2000LUX
- Tiempo: 10 SEC + 3 SEC (REGULABLE)
- Distancia: 6 metros
- Máx: 2 x 40w (E27)
- 360° Detección

SENSOR PIR DE MOVIMIENTO

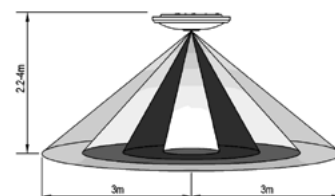
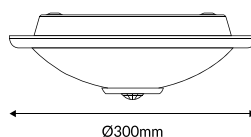

ESPECIAL ESCALERAS

PLAFÓN CON SENSOR DE MOVIMIENTO

16W 1100Lm 4000K

DOW-348 44,85€

PLAFÓN CON SENSOR DE MOVIMIENTO

16W 1100Lm 5500K

DOW-349 44,85€



SENSOR PIR DE MOVIMIENTO

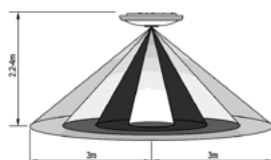
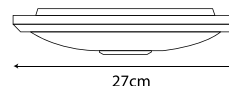

USOS: PASILLOS, ZONAS COMUNES,...

LED INCLUIDO

K°

Ref

PVPR

PLAFÓN LED SENSOR PIR 15W 1200Lm



4000K

DOW-379

17,82 €

Plafón led 3CCT 3200K / 4200K / 5000K

PLAFÓN LED SENSOR PIR 15W 1200Lm



3CCT

DOW-381

17,82 €

PLAFÓN LED SENSOR PIR 20W 1600Lm



3CCT

DOW-382

17,82 €



SENSOR PIR DE MOVIMIENTO



15w

ESPECIAL ESCALERAS

NEW!

* Según la nueva normativa ERP ha habido un cambio en la medición de Lúmenes y vatios, pero sigue emitiendo la misma cantidad de luz.

A medida que vayan entrando los nuevos modelos con ERP se irá actualizando en catálogo y cajas de color.

Puede haber variación respecto la caja del producto (comprobar en ficha técnica), todos los datos en catálogo están correctos salvo error tipográfico.

Plafon 3CCT - Con sensor de movimiento y sistema de emergencia



SISTEMA DE EMERGENCIA INCLUIDO

3 POTENCIAS
12w/15w/18w

3 en 1 TRES TIPOS DE LUZ EN LA MISMA LUMINARIA

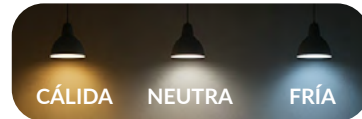

Switch **3CCT**



ESPECIAL ESCALERAS

SISTEMA DE EMERGENCIA INCLUIDO Potencia carga 20w 1500Lm



GRAN AUTONOMÍA 60MIN



Li-ion 3,2V 1800mAh

LED INCLUIDO

	K°	Ref	PVPR
PLAFÓN CON SENSOR DE MOVIMIENTO Y EMERGENCIA	3CCT	DOW-360	41,04€

12 W

15 W

18 W

230 V

1

360°



SENSOR PIR DE MOVIMIENTO

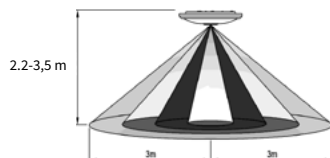

Proyector 2 MODELOS DE PROYECTOR



AJUSTA EL COLOR de luminosidad en cualquier momento que desees con el nuevo **PRY-138**

3 en 1 TRES TIPOS DE LUZ EN LA MISMA LUMINARIA

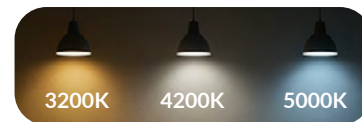

El **Foco Proyector Direccional Rectangular LED** combina a la perfección diseño, potencia y ahorro energético.

Estas cualidades lo convierten en una opción **muy interesante para** la iluminación de **espacios comerciales**.

Cuenta con un diseño que distribuye la luz en un ángulo de apertura de 120° que, en combinación con el difusor opal que incluye, proporciona una iluminación muy homogénea que minimiza los reflejos y el deslumbramiento.

High Efficiency
120lm/w



No incluye pilas en el precio

COMPATIBLE CON APP **tuya**

PRY-138 - CON WIFI Y CONTROL REMOTO RF

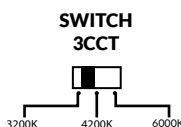

PRY-138-2 - LED DRIVER CON SWITCH



	K°	Ref	PVPR
PROYECTOR DOWNLIGHT RECTANGULAR BLANCO WIFI - 40w 3CCT PRY-138			142,56€



PROYECTOR DOWNLIGHT RECTANGULAR BLANCO 40w 3CCT PRY-138-2			101,97€
--	--	--	---------



DOWNLIGHT FOCO EMPOTRADO



DOWNLIGHT RECTANGULAR FOCO BLANCO 3000lm - 30w 3200K DOW-183			108,33€
---	--	--	---------

DOWNLIGHT RECTANGULAR FOCO BLANCO 3800lm - 50w 3200K DOW-161			139,62€
---	--	--	---------

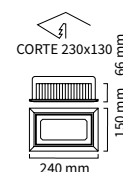

* Según la nueva normativa ERP ha habido un cambio en la medición de Lúmenes y vatios, pero sigue emitiendo la misma cantidad de luz.

A medida que vayan entrando los nuevos modelos con ERP se irá actualizando en catálogo y cajas de color.

Puede haber variación respecto la caja del producto (comprobar en ficha técnica), todos los datos en catálogo están correctos salvo error tipográfico.



ACCESORIOS **DOWNLIGHT**



Ref PVPR



LED DRIVER PARA DOWNLIGHT

6w

AXLED-006

5,43€

LED DRIVER PARA DOWNLIGHT

12w

AXLED-007

7,23€



LED DRIVER PARA DOWNLIGHT

18w

AXLED-008

7,95€



LED DRIVER PARA DOWNLIGHT

25w

AXLED-009

10,80€

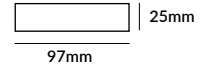

LED DRIVER **DIMMABLE TRIAC** PARA DOWNLIGHT

6w

AXLED-016

8,67€

LED DRIVER **DIMMABLE TRIAC** PARA DOWNLIGHT

12w

AXLED-015

8,67€



LED DRIVER **DIMMABLE TRIAC** PARA DOWNLIGHT

18w

AXLED-004

27,12€

LED DRIVER **DIMMABLE TRIAC** PARA DOWNLIGHT **NEW**

24w

AXLED-022

35,94€



LED DRIVER **DIMMABLE TRIAC** PARA DOWNLIGHT

25w

AXLED-005

35,94€



FUNCIONAMIENTO **BOTÓN ON REGULACIÓN +**
REGULACIÓN PULSANDO EL BOTÓN BOTÓN OFF REGULACIÓN -



MANDO PARA PASTILLA CONTR-022

4 Zonas 2.4Ghz

CONTR-036

39,57€



No incluye pilas en el precio



CIRCULAR LED COB

20W 120°

BLED-025

63,21€



LED DRIVERS **DIMMABLE TRIAC** PARA DOWNLIGHT PHOENIX 25W AXLED-020

35,94€



LED DRIVERS **DIMMABLE TRIAC** PARA DOWNLIGHT PHOENIX 42W AXLED-021

47,31€



LED SPD-20-240P
Protege sobretensiones de hasta 20kA

PROTECTOR SOBRETENSIÓN TRANSITORIO PARA LED

AXLED-011

54,00€

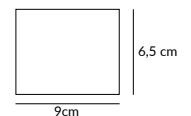

Con AUTOTEST Homologado

KIT DE EMERGENCIA PARA DOWNLIGHTS Y PANEL LED

EMR-026

69,60€

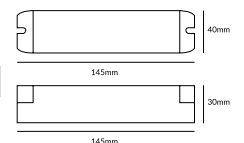



Para interruptor simple, conmutado y cruce



PASTILLA INTERRUPTOR MINI LED **WiFi 300W LED** Ref: CONTR-054 PVPR: 41,91€ **tuya**

230 V -

No apta para instalaciones conmutables



PASTILLA INTERRUPTOR MINI MULTIFUNCIÓN **WiFi 300W LED** Ref: CONTR-082 PVPR: 29,85€ **tuya**

230 V -

Para DOBLE interruptor, interruptor partido y conmutado



PASTILLA DOBLE INTERRUPTOR LED **WiFi 2 X 150W** Ref: CONTR-042 PVPR: 56,31€ **tuya**

230 V -

Disponible para varios pulsadores



Para varios pulsadores **REGULACIÓN TRIAC**

PASTILLA **DIMMABLE TRIAC** **WiFi 300W LED** **WiFi 300W LED** Ref: CONTR-063 PVPR: 60,66€ **tuya**

230 V -



PASTILLA TELERRUPTOR MINI **WiFi 16A 230V - 300W LED** Ref: CONTR-071 PVPR: 45,06€ **tuya**

230 V -

NEW!



REGULACIÓN TRIAC **DIMMABLE 0-100% SIN PARPADEO**

CONTROLADOR **DIMMABLE TRIAC** **WiFi PULSADOR** **WiFi 500W LED** Ref: CONTR-096 PVPR: 84,30€ **tuya**

230 V - CONEXIÓN **WiFi**, 2,4Ghz, **BLUETOOTH** / CONTROL REMOTO 2,4Ghz

NEW!



PASTILLA **DIMMABLE TRIAC** **WiFi RF UART HOLE** **200W** Ref: CONTR-104 PVPR: 58,50€ **tuya**

230 V -



Accesorio control remoto pulsador dimmable Ref: CONTR-105 (No incluido) PVPR: 20,37€

NO DISPONE DE **WiFi**



PASTILLA PULSADOR CON EFECTO MEMORIA - FUNCIONA PARA VARIOS PULSADORES - NO DISPONE DE **WiFi**

PASTILLA **DIMMABLE TRIAC** POR PULSADOR **MÁX 360W** Ref: CONTR-022 PVPR: 52,62€



CONTR-036 CONTR-098

COMPATIBLE CON MANDO CONTR-036 Y CONTR-098

REGULACIÓN TRIAC

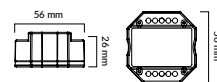

PASTILLA **DIMMABLE TRIAC** LED **SIN NEUTRO** **MÁX 250W** Ref: CONTR-083 PVPR: 55,02€

Este dimmer LED está diseñado para el control de lámparas LED regulables de hasta 250W. Con características de diseño compacto, brillo ajustable, potencia y memoria de ajuste de luz, es fácil de instalar y operar.

- Tamaño compacto
- Sin ruido
- Regulación del borde de salida
- No necesita línea neutra
- Ideal para reequipamiento
- Luminosidad y velocidad de regulación regulables
- Memoria de potencia y luminosidad

REGULACIÓN TRIAC

- **REGULACIÓN TRIAC**
- **NO DISPONE DE WiFi**
- **NO APTA PARA INSTALACIONES CONMUTADAS**
- **SE PUEDE USAR CON PULSADORES EN PARALELO**

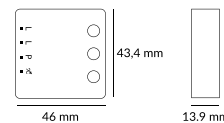





Serie Luminaria Lineal



LIFUD
Led Driver

3 en 1 TRES TIPOS DE LUZ
EN LA MISMA LUMINARIA



NEW!

SERIE ALUMINIO

Luminaria lineal 3CCT - 2700K ● 4200K ● 5000K ●

LUMINARIA LINEAL SUSPENDIDA	36w 1200mm Blanco	3CCT	DOW-372	107,55€
LUMINARIA LINEAL SUSPENDIDA	36w 1200mm Negro	3CCT	DOW-373	107,55€



Longitud cable: 1,5metros

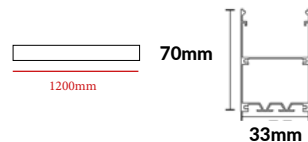

NEW PRICE!!

SERIE ALUMINIO

Luminaria lineal 3CCT - 3200K ● 4200K ● 5000K ●

LUMINARIA LINEAL SUSPENDIDA	36w 1200mm Blanco	3CCT	DOW-352	107,55€
LUMINARIA LINEAL SUSPENDIDA	36w 1200mm Negro	3CCT	DOW-353	107,55€



Longitud cable: 1,5metros

ACC. DE SUSPENSIÓN INCLUIDOS

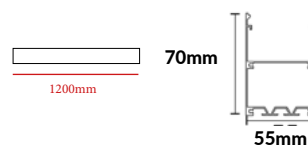

NEW!

SERIE ALUMINIO

Luminaria lineal MONOCOLOR

LUMINARIA LINEAL SUSPENDIDA	36w 1200mm Negro	4000K	DOW-370	80,25€
LUMINARIA LINEAL SUSPENDIDA	36w 1200mm Blanco	4000K	DOW-371	80,25€



Longitud cable: 1,5metros

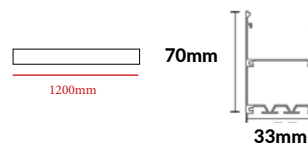

Accesorios para lineales

Genera estructuras con estos accesorios

Convierta su lineal en bañador de pared

Con esta **unión directa** conseguirás un diseño que es capaz de integrarse en diversos entornos arquitectónicos, con ello la luz se integra en el espacio y se convierten en una parte esencial del propio diseño de interiores.

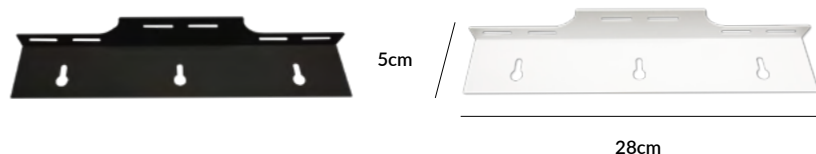

Ref	PVPR
ACLED-463 - Negro	5,16€
ACLED-468 - Blanco	5,16€

Ref	PVPR
ACLED-462	0,75€



SERIE PLASTIC



3 en 1 TRES TIPOS DE LUZ EN LA MISMA LUMINARIA

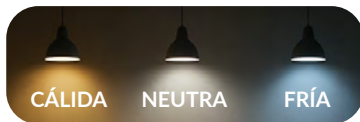

	K°	Ref	PVPR
LUMINARIA LINEAL SUSPENDIDA/SUPERFICIE 35w Negro	3CCT	DOW-369	29,88€
LUMINARIA LINEAL SUSPENDIDA/SUPERFICIE 35w Blanco	3CCT	DOW-368	29,88€



FORMAS DE COLOCACIÓN:

SUPERFICIE



SUSPENDIDA

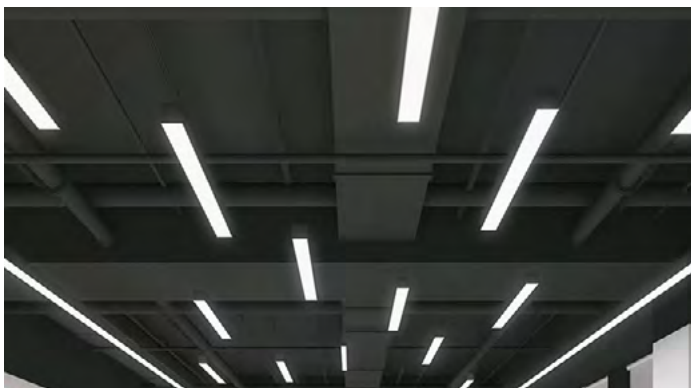
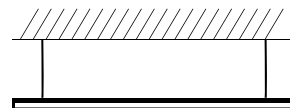

* Según la nueva normativa ERP ha habido un cambio en la medición de Lúmenes y vatios, pero sigue emitiendo la misma cantidad de luz. A medida que vayan entrando los nuevos modelos con ERP se irá actualizando en catálogo y cajas de color. Puede haber variación respecto la caja del producto (comprobar en ficha técnica), todos los datos en catálogo están correctos salvo error tipográfico.





Serie Track light

Serie Track light - Aluminio

PARA
DICROICA GU10



NEW!



TRACK LIGHT KIT 2

SUPERFICIE

ALUMINIO - TRACK LIGHT SUPERFICIE - NO INCLUYE BOMBILLA

LED TRACK LIGHT *Negro*
LED TRACK LIGHT *Blanco*

Ref	PVPR
TRCK-079	28,23€
TRCK-080	28,23€

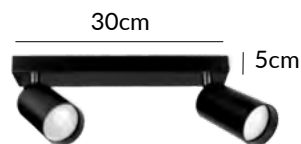

NEW!



TRACK LIGHT KIT 3

SUPERFICIE

ALUMINIO - TRACK LIGHT SUPERFICIE - NO INCLUYE BOMBILLA

LED TRACK LIGHT *Negro*
LED TRACK LIGHT *Blanco*

Ref	PVPR
TRCK-082	34,32€
TRCK-081	34,32€



NEW!



TRACK LIGHT KIT 4

SUPERFICIE

ALUMINIO - TRACK LIGHT SUPERFICIE - NO INCLUYE BOMBILLA

LED TRACK LIGHT *Negro*
LED TRACK LIGHT *Blanco*

Ref	PVPR
TRCK-097	47,67€
TRCK-098	47,67€



Serie Track light - Aluminio

PARA
DICROICA GU10



DIFERENTES FORMAS DE COLOCACIÓN



ORIENTABLE 360°

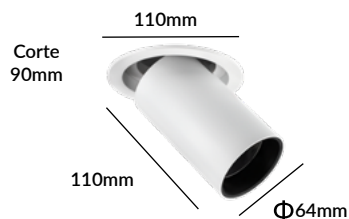

DISEÑO MODERNO

EMPOTRADO CON ARO

SERIE ALUMINIO

ALUMINIO - EMPOTRADO - NO INCLUYE LÁMPARA



	Ref	PVPR
TRACK LIGHT EMPOTRADO PARA Lámpara GU10	<i>Aluminio Blanco</i>	TRCK-099 41,16€
TRACK LIGHT EMPOTRADO PARA Lámpara GU10	<i>Aluminio Negro</i>	TRCK-100 41,16€



DISEÑO MODERNO

SUPERFICIE

SERIE ALUMINIO

ALUMINIO - SUPERFICIE - NO INCLUYE LÁMPARA



	Ref	PVPR
TRACK LIGHT PARA Lámpara GU10	<i>Aluminio Blanco</i>	TRCK-061 14,40 €
TRACK LIGHT PARA Lámpara GU10	<i>Aluminio Negro</i>	TRCK-062 14,40 €

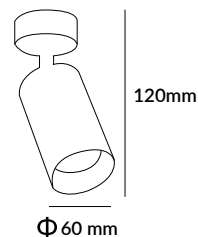

CARRIL

SERIE ALUMINIO

ALUMINIO - CONEXIÓN CARRIL TRIFÁSICO - NO INCLUYE LÁMPARA



	Ref	PVPR
TRACK LIGHT CARRIL TRIFÁSICO	<i>Dicroica GU10 - Blanco</i>	TRCK-029 31,32€
TRACK LIGHT CARRIL TRIFÁSICO	<i>Dicroica GU10 - Negro</i>	TRCK-030 31,32€



NO VÁLIDO PARA DIC-066/077/067/084/065/085

Convierte tu track light de carril en un track light de superficie $\varnothing 11mm$

TRCK-041 - Blanco	TRCK-042 - Negro
9,90€	9,90€

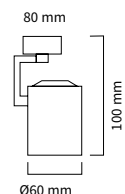

Serie Track light - Aluminio

PARA
BOMBILLA QR111
Y PAR27

QR111

E27



SUPERFICIE



ALUMINIO - SUPERFICIE - NO INCLUYE LÁMPARA

TRACK LIGHT SUPERFICIE	QR111 - GU10 - Blanco	TRCK-026	39,00€
TRACK LIGHT SUPERFICIE	QR111 - GU10 - Negro	TRCK-025	39,00€

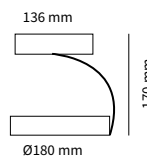

CARRIL



ALUMINIO - CONEXIÓN CARRIL TRIFÁSICO - NO INCLUYE LÁMPARA

TRACK LIGHT CARRIL TRIFÁSICO	QR111 - GU10 - Blanco	TRCK-028	44,76€
TRACK LIGHT CARRIL TRIFÁSICO	QR111 - GU10 - Negro	TRCK-027	44,76€

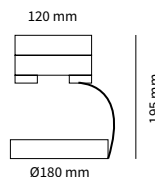

Accesorios

Superficie

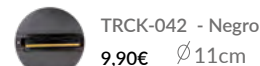
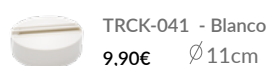

INTERCAMBIABLE
MODULAR
SYSTEM



SUPERFICIE

ALUMINIO - SUPERFICIE - NO INCLUYE LÁMPARA

		Ref	PVPR
TRACK LIGHT SUPERFICIE	PAR30 - E27 Blanco	TRCK-015	41,52€
TRACK LIGHT SUPERFICIE	PAR30 - E27 Negro	TRCK-016	41,52€

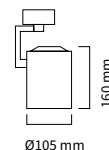

CARRIL

INTERCAMBIABLE
MODULAR
SYSTEM



ALUMINIO - CONEXIÓN CARRIL TRIFÁSICO - NO INCLUYE LÁMPARA

TRACK LIGHT CARRIL TRIFÁSICO	PAR30 - E27 Blanco	TRCK-001	49,47€
TRACK LIGHT CARRIL TRIFÁSICO	PAR30 - E27 Negro	TRCK-011	49,47€

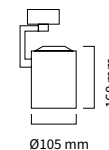

Accesorios

Superficie

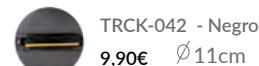
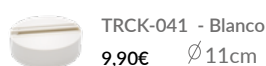

Serie Track light - Aluminio

LED INCLUIDO

- DRIVER INCLUIDO EN EL CARRIL PARA UN DISEÑO MÁS ESTILIZADO.
- EVITA TRANSFERENCIA DE CALOR DEL DRIVER AL PROYECTOR.
- MATERIAL ALUMINIO.

3 en 1 TRES TIPOS DE LUZ EN LA MISMA LUMINARIA

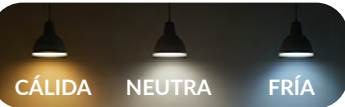

LED DRIVER ALTA CALIDAD **LIFUD®**



ÁNGULO REGULABLE 15-60°

ALUMINIO - CONEXIÓN CARRIL TRIFÁSICO - LED INTEGRADO

	30w	K°	Ref	PVPR
LED TRACK LIGHT 3CCT	30w Blanco	3CCT	TRCK-105	59,85€
LED TRACK LIGHT 3CCT	30w Negro	3CCT	TRCK-106	59,85€



SERIE ALUMINIO

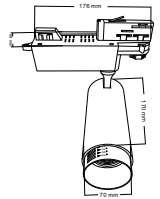



SERIE ALUMINIO

5 en 1 CINCO TIPOS DE LUZ EN LA MISMA LUMINARIA



LED DRIVER
ALTA CALIDAD

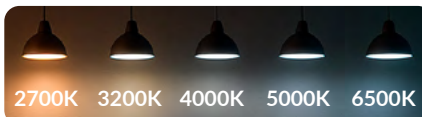
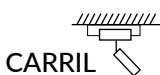

Switch
5CCT

ALUMINIO - CONEXIÓN CARRIL TRIFÁSICO - LED INTEGRADO

	K°	Ref	PVPR
LED TRACK LIGHT 5CCT	30w Blanco	5CCT	TRCK-374 44,85 €
LED TRACK LIGHT 5CCT	30w Negro	5CCT	TRCK-375 44,85 €

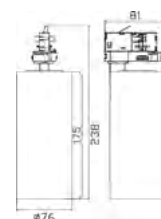

Accesorios

Superficie

TRCK-041 - Blanco
9,90€ Ø11cm

TRCK-042 - Negro
9,90€ Ø11cm

TRCK-071 - Blanco
5,76€ Ø9,9cm

TRCK-072 - Negro
5,76€ Ø9,9cm

Empotrar

TRCK-073 - Blanco
6,48€

TRCK-074 - Negro
6,48€ Ø11cm

Corte
Ø10,5cm

Diametro exterior
Ø12cm

3 en 1 TRES TIPOS DE LUZ EN LA MISMA LUMINARIA



LED DRIVER
ALTA CALIDAD



Switch
3CCT

ALUMINIO - CONEXIÓN CARRIL TRIFÁSICO - LED INTEGRADO

	K°	Ref	PVPR
LED TRACK LIGHT 3CCT	30w Blanco	3CCT	TRCK-059 65,85€
LED TRACK LIGHT 3CCT	30w Negro	3CCT	TRCK-060 65,85€



USED
bridgelux
LED CHIPS



LENTE
INTERCAMBIABLE

- ADAPTADOR LENTE 36°
- ADAPTADOR LENTE 55°



PVPR

TRCK-063 ADAPTADOR LENTE 36° PARA TRACK LIGHT -059 AL -060

3,18€

TRCK-064 ADAPTADOR LENTE 55° PARA TRACK LIGHT -059 AL -060

4,65€

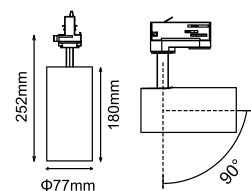

Accesorios

Superficie

TRCK-041 - Blanco
9,90€ Ø11cm

TRCK-042 - Negro
9,90€ Ø11cm



SERIE ALUMINIO



CARRIL

ALUMINIO - CONEXIÓN CARRIL TRIFÁSICO - LED INTEGRADO

	K°	Ref	PVPR
TRACK LIGHT LED INTEGRADO <i>Blanco 3000Lm</i>	4000K	TRCK-370	41,58 €
TRACK LIGHT LED INTEGRADO <i>Negro 3000Lm</i>	4000K	TRCK-371	41,58 €
TRACK LIGHT LED INTEGRADO <i>Negro 3000Lm</i>	3200K	TRCK-373	41,58 €

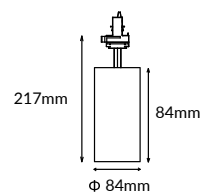

Accesorios

Superficie



TRCK-041 - Blanco
9,90€ ∅ 11cm



TRCK-042 - Negro
9,90€ ∅ 11cm



TRCK-071 - Blanco
5,76€ ∅ 9,9cm



TRCK-072 - Negro
5,76€ ∅ 9,9cm

Empotrar



TRCK-073 - Blanco
6,48€



TRCK-074 - Negro
6,48€ ∅ 11cm

Corte
∅ 10,5cm

Diametro exterior
∅ 12cm



**NUEVO
DISEÑO**



High Efficiency
100Lm/w



**RENDIMIENTO
CROMÁTICO
ALTA CALIDAD**



LED INTEGRADO - Aluminio - Carril TRIFÁSICO - Chip COB

			K°	Ref	PVPR
TRACK LIGHT LED INTEGRADO	30W Blanco	4200K	●	TRCK-032	80,85€
TRACK LIGHT LED INTEGRADO	30W Blanco	5000K	●	TRCK-033	80,85€
TRACK LIGHT LED INTEGRADO	30W Negro	3200K	●	TRCK-034	80,85€
TRACK LIGHT LED INTEGRADO	30W Negro	4200K	●	TRCK-035	80,85€
TRACK LIGHT LED INTEGRADO	30W Negro	5000K	●	TRCK-036	80,85€

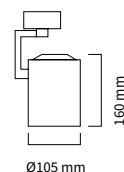

ADAPTADOR LENTE 24°



TRCK-055 ACCESORIO TRACK LIGHT -032 AL -036

5,61€

**CONVIERTE TU TRACK LIGHT
EN REGULABLE**

Fácil sustitución



Led Driver track light dimmable triac
TRCK-053 - Blanco
50,70€



Led Driver track light dimmable triac
TRCK-054 - Negro
50,70€



Track light DOMÓTICO

2 MODOS DE CONTROL WIFI + CONTROLADOR RF 2.4Ghz



CONTROLADOR REMOTO



COMPATIBLE CON APP **tuya**



3 en 1 TRES TIPOS DE LUZ EN LA MISMA LUMINARIA

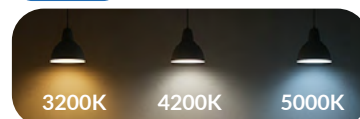

* REGULABLE - CARRIL TRIFÁSICO

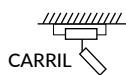

LED INTEGRADO

	K°	Ref	PVPR
TRACK LIGHT LED INTEGRADO 3CCT WiFi 30W Blanco	3CCT	TRCK-056	125,94€
TRACK LIGHT LED INTEGRADO 3CCT WiFi 30W Negro	3CCT	TRCK-057	125,94€



EL TRACK LIGHT DEBE ESTAR VINCULADO PARA PODER UTILIZAR EL MANDO A DISTANCIA.

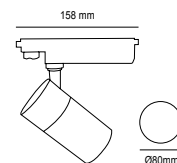

* Según la nueva normativa ERP ha habido un cambio en la medición de Lúmenes y vatios, pero sigue emitiendo la misma cantidad de luz. A medida que vayan entrando los nuevos modelos con ERP se irá actualizando en catálogo y cajas de color. Puede haber variación respecto la caja del producto (comprobar en ficha técnica), todos los datos en catálogo están correctos salvo error tipográfico.



Downlight de proyección **dimmable 3CCT**

3 en 1 TRES TIPOS DE LUZ
EN LA MISMA LUMINARIA

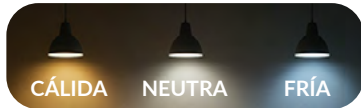

Switch
3CCT

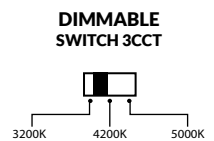
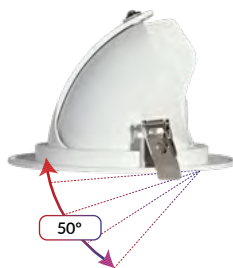

*** BASCULANTE 50° - 3CCT - DIMMABLE TRIAC**

DOWNLIGHT CIRCULAR DIMMABLE TRIAC 🌞 **38W Blanco** 3CCT 🌐 DOW-322 95,85€

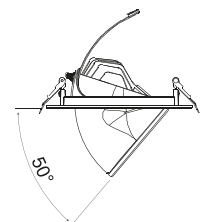
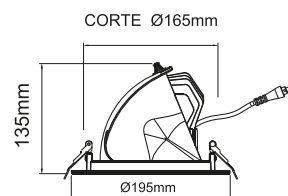



Carril track light empotrado ↓



		Ref	PVPR
TRACK RAIL EMPOTRAR 4 HILOS	<i>2Metros Negro</i>	TRCK-083	82,32€
TRACK RAIL EMPOTRAR 4 HILOS	<i>2Metros Blanco</i>	TRCK-084	82,32€
TRACK RAIL EMPOTRAR 4 HILOS	<i>3Metros Negro</i>	TRCK-085	123,45€
TRACK RAIL EMPOTRAR 4 HILOS	<i>3Metros Blanco</i>	TRCK-086	123,45€

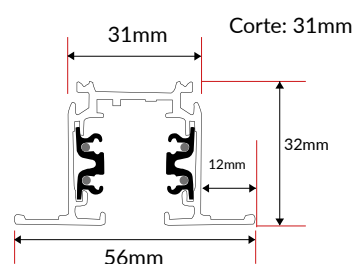

Carril track light superficie



TRACK RAIL 1METRO	<i>TRIFÁSICO 3 ENCENDIDOS</i>	<i>Blanco</i>	TRCK-013	31,59€
TRACK RAIL 1METRO	<i>TRIFÁSICO 3 ENCENDIDOS</i>	<i>Negro</i>	TRCK-014	31,59€
TRACK RAIL 2METROS	<i>TRIFÁSICO 3 ENCENDIDOS</i>	<i>Blanco</i>	TRCK-002	63,18€
TRACK RAIL 2METROS	<i>TRIFÁSICO 3 ENCENDIDOS</i>	<i>Negro</i>	TRCK-012	63,18€

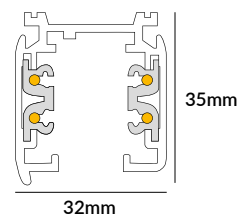

ESQUEMA DE CONEXIÓN TRACK RAIL

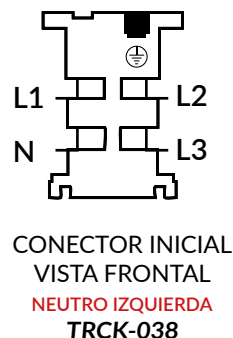
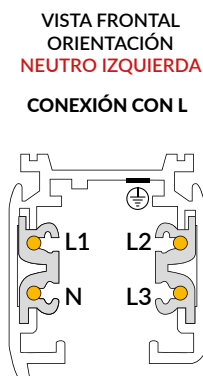
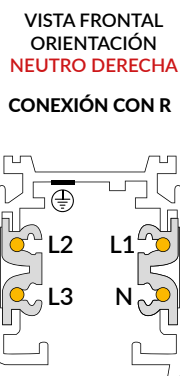
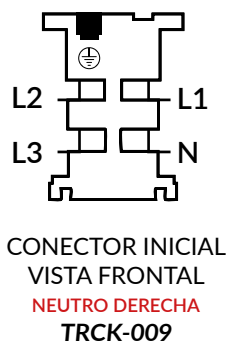

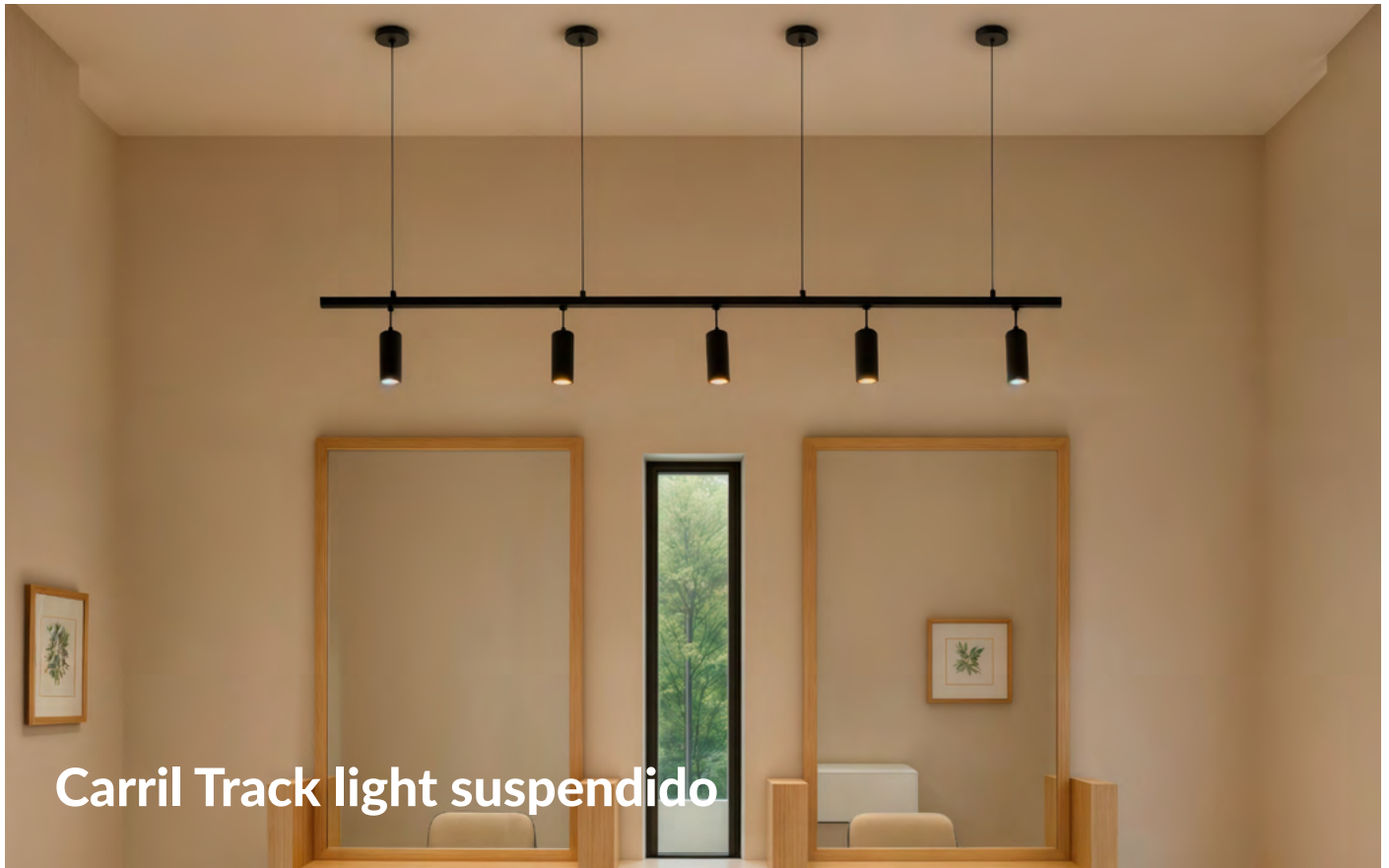

Carril Track light suspendido



REDONDO

			Ref	PVPR
ACCESORIOS SUSPENSIÓN 1 METRO	PARA RAIL BLANCO	Blanco	TRCK-008	17,28€
ACCESORIOS SUSPENSIÓN 1 METRO	PARA RAIL NEGRO	Negro	TRCK-022	17,28€



REDONDO

ACCESORIOS SUSPENSIÓN 2 METROS	PARA RAIL BLANCO	Blanco	TRCK-069	17,88€
ACCESORIOS SUSPENSIÓN 2 METROS	PARA RAIL NEGRO	Negro	TRCK-070	17,88€



CUADRADO

NEW!

ACCESORIOS SUSPENSIÓN 2 METROS	PARA RAIL BLANCO	Blanco	TRCK-067	7,35€
ACCESORIOS SUSPENSIÓN 2 METROS	PARA RAIL NEGRO	Negro	TRCK-068	7,35€



CUADRADO

NEW!

ACCESORIOS SUSPENSIÓN 1 METRO	PARA RAIL BLANCO	Blanco	TRCK-065	6,75€
ACCESORIOS SUSPENSIÓN 1 METRO	PARA RAIL NEGRO	Negro	TRCK-066	6,75€

ACCESORIOS TRACK LIGHT

* CONSULTAR ESQUEMA
INSTALACIÓN PAG 45



			Ref	PVPR
	TAPA FINAL PARA RAIL BLANCO	Blanco	TRCK-010	1,02€
	TAPA FINAL PARA RAIL NEGRO	Negro	TRCK-024	1,02€
	CONECTOR INICIAL PARA RAIL CON TAPA BLANCO DERECHA	Blanco	TRCK-009	7,35€
	CONECTOR INICIAL PARA RAIL CON TAPA NEGRO DERECHA	Negro	TRCK-023	7,35€
	CONECTOR INICIAL PARA RAIL CON TAPA BLANCO IZQUIERDA	Blanco	TRCK-038	7,35€
	CONECTOR INICIAL PARA RAIL CON TAPA NEGRO IZQUIERDA	Negro	TRCK-037	7,35€
	UNIÓN "I" PARA RAIL BLANCO	Blanco	TRCK-003	12,51€
	UNIÓN "I" PARA RAIL NEGRO	Negro	TRCK-017	12,51€
	UNION "I" INTERIOR PARA RAIL BLANCO	Blanco	TRCK-051	7,35€
	UNION "I" INTERIOR PARA RAIL NEGRO	Negro	TRCK-052	7,35€
	UNIÓN "L" PARA RAIL BLANCO DERECHA	Blanco	TRCK-006	12,81€
	UNIÓN "L" PARA RAIL NEGRO DERECHA	Negro	TRCK-020	12,81€
	UNION "L" PARA RAIL BLANCO IZQUIERDA	Blanco	TRCK-039	12,81€
	UNION "L" PARA RAIL NEGRO IZQUIERDA	Negro	TRCK-040	12,81€
	UNIÓN "T" PARA RAIL BLANCO IZQUIERDA-ARRIBA	Blanco	TRCK-004	19,44€
	UNIÓN "T" PARA RAIL NEGRO IZQUIERDA-ARRIBA	Negro	TRCK-018	19,44€
	UNIÓN "T" PARA RAIL BLANCO IZQUIERDA - BAJO	Blanco	TRCK-043	19,44€
	UNIÓN "T" PARA RAIL NEGRO IZQUIERDA - BAJO	Negro	TRCK-046	19,44€
	UNIÓN "T" PARA RAIL BLANCO DERECHA - ARRIBA	Blanco	TRCK-044	19,44€
	UNIÓN "T" PARA RAIL NEGRO DERECHA - ARRIBA	Negro	TRCK-047	19,44€
	UNIÓN "T" PARA RAIL BLANCO DERECHA - BAJO	Blanco	TRCK-045	19,44€
	UNIÓN "T" PARA RAIL NEGRO DERECHA - BAJO	Negro	TRCK-048	19,44€
	UNIÓN "X" PARA RAIL BLANCO DERECHA	Blanco	TRCK-007	24,24€
	UNIÓN "X" PARA RAIL NEGRO DERECHA	Negro	TRCK-021	24,24€
	UNIÓN "FLEX" PARA RAIL BLANCO	Blanco	TRCK-005	20,97€
	UNIÓN "FLEX" PARA RAIL NEGRO	Negro	TRCK-019	20,97€

* Según la nueva normativa ERP ha habido un cambio en la medición de Lúmenes y vatios, pero sigue emitiendo la misma cantidad de luz.

A medida que vayan entrando los nuevos modelos con ERP se irá actualizando en catálogo y cajas de color.

Puede haber variación respecto la caja del producto (comprobar en ficha técnica), todos los datos en catálogo estan correctos salvo error tipográfico.

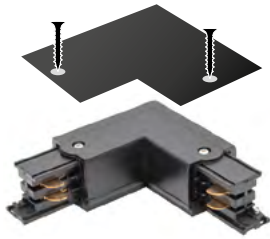

NEW!

ACCESORIOS TRACK LIGHT EMPOTRADOS

Haz tu instalación empotrada

Se puede adquirir la cubierta para hacer tu instalación empotrada.

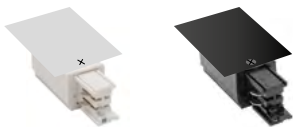

PARA TRCK-009/023 - TRCK-038/037



		Ref	PVPR
CUBIERTA PARA CONECTOR INICIAL	Negro	TRCK-087	1,14€
CUBIERTA PARA CONECTOR INICIAL	Blanco	TRCK-088	1,14€

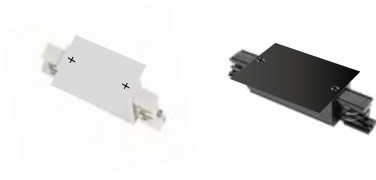

PARA TRCK-003/017



CUBIERTA PARA TRCK UNION "I"	Negro	TRCK-091	1,86€
CUBIERTA PARA TRCK UNION "I"	Blanco	TRCK-092	1,86€



PARA TRCK-006/020 - 039/040



CUBIERTA PARA TRCK UNION "L"	Negro	TRCK-089	1,86€
CUBIERTA PARA TRCK UNION "L"	Blanco	TRCK-090	1,86€



PARA TRCK-004/018 - 043/046 - 044/047 - 045/048



CUBIERTA PARA TRCK UNION "T"	Negro	TRCK-093	2,25€
CUBIERTA PARA TRCK UNION "T"	Blanco	TRCK-094	2,25€



PARA TRCK-007/021



CUBIERTA PARA TRCK UNION "X"	Negro	TRCK-095	2,61€
CUBIERTA PARA TRCK UNION "X"	Blanco	TRCK-096	2,61€

CONECTOR INICIAL

TRCK 009/023 TRCK 038/037

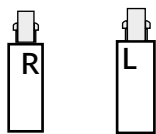

UNIÓN "I"

TRCK-003/017 TRCK-051/052

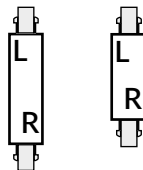

UNIÓN "T"
TRCK-004/018

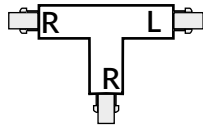

UNIÓN "T"
TRCK-043/046

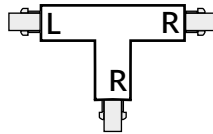

UNIÓN "X"
TRCK-007/021

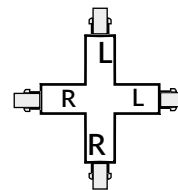

UNIÓN "T"
TRCK-044/047

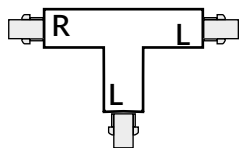

UNIÓN "T"
TRCK-045/048

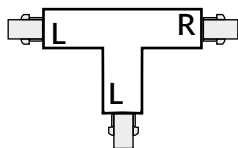

UNIÓN "L"
TRCK-006/020

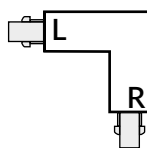

UNIÓN "L"
TRCK-039/040

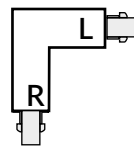

UNIÓN "FLEX"
TRCK-005/019



EJEMPLO INSTALACIÓN

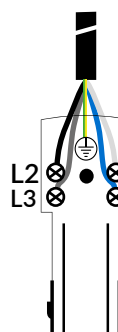
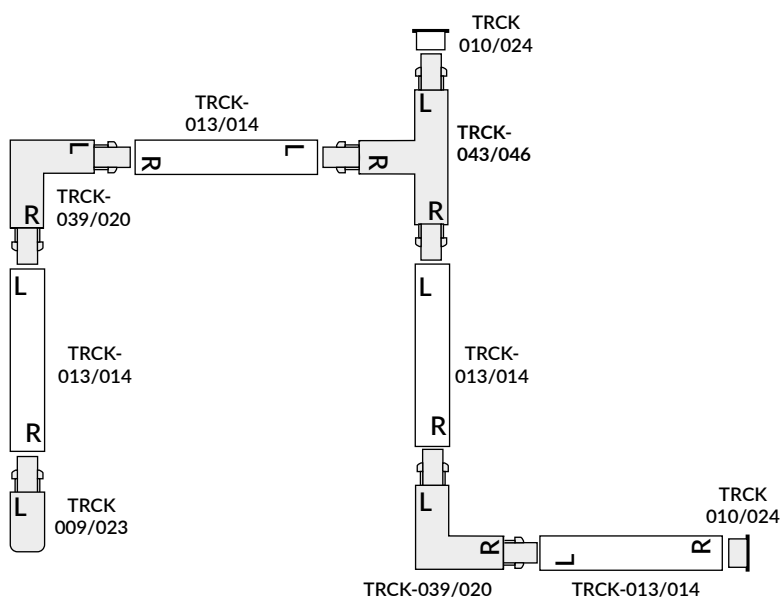

CONECTOR INICIAL
VISTA SUPERIOR
NEUTRO DERECHA
TRCK-009

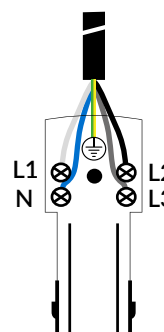

CONECTOR INICIAL
VISTA SUPERIOR
NEUTRO IZQUIERDA
TRCK-038

RESPECTAR LA ORIENTACIÓN DEL NEUTRO PARA LA CONEXIÓN. LAS CONEXIONES ENTRE ACCESORIOS Y TRACK RAIL SE REALIZARÁN SIEMPRE CONECTANDO "R" CON "L" O VICEVERSA.

ESQUEMA DE CONEXIÓN TRACK RAIL

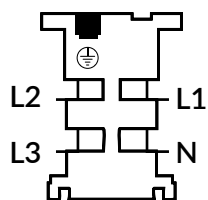

CONECTOR INICIAL
VISTA FRONTAL
NEUTRO DERECHA
TRCK-009

VISTA FRONTAL
ORIENTACIÓN
NEUTRO DERECHA
CONEXIÓN CON R

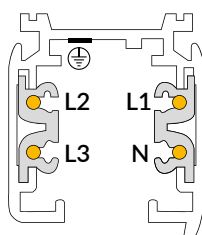

VISTA FRONTAL
ORIENTACIÓN
NEUTRO IZQUIERDA
CONEXIÓN CON L

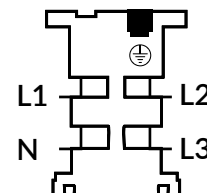
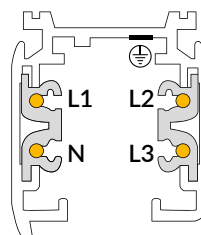

CONECTOR INICIAL
VISTA FRONTAL
NEUTRO IZQUIERDA
TRCK-038

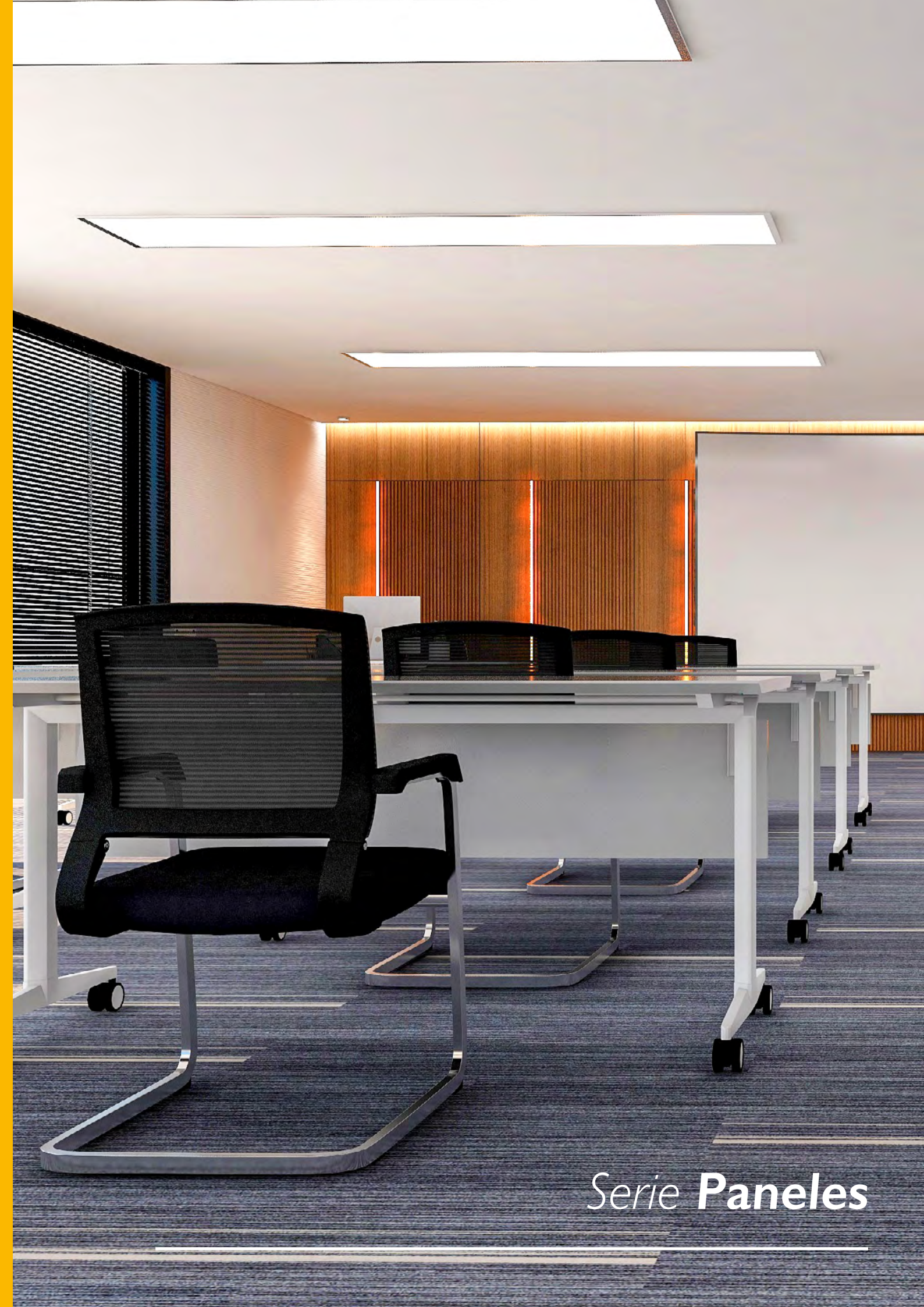

Serie **Paneles**

Serie Paneles empotrado

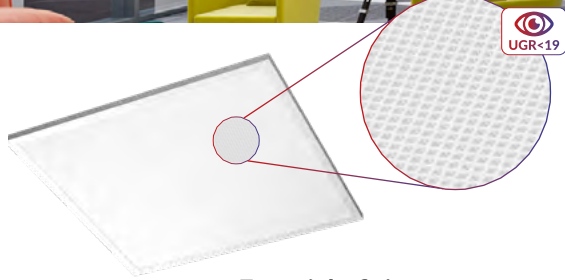

Especial oficinas,
zonas de trabajo,..

La **pantalla LED UGR<19** se basa en controlar el deslumbramiento molesto también llamado deslumbramiento psicológico dando una **mejor calidad visual** al observador.

Gracias a su control de deslumbramiento es ideal para oficinas, zonas de trabajo, etc. ya que **reduce la fatiga visual**.

- Mejor calidad visual.
- Reduccion fatiga visual.
- Fuente de alimentación **LIFUD** de alta calidad



PANEL LED EMPOTRADO UGR<19



LIFUD
Led Driver

PANEL
ULTRA SLIM

NEW!

			K°	Ref	PVPR
PANEL LED SLIM	60 X 60CM	UGR<19 40W - ARO BLANCO	4200K	DOW-483	41,85€
PANEL LED SLIM	60 X 60CM	UGR<19 40W - ARO BLANCO	5000K	DOW-484	41,85€

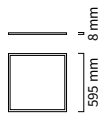

PANEL LED EMPOTRADO UGR<19



LIFUD
Led Driver

			K°	Ref	PVPR
PANEL LED AT-40	60 X 60CM	UGR<19 40W - ARO BLANCO	4200K	DOW-256	47,40€
PANEL LED AT-40	60 X 60CM	UGR<19 40W - ARO BLANCO	5000K	DOW-257	47,40€

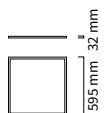

NEW
PRICE!!

PANEL LED AT-40	30 X 120CM	UGR<19 40W - ARO BLANCO	4200K	DOW-260	50,34€
PANEL LED AT-40	30 X 120CM	UGR<19 40W - ARO BLANCO	5000K	DOW-261	50,34€

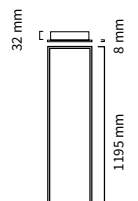

NEW
PRICE!!

PANEL LED AT-40	60 X 120CM	UGR<19 80W - ARO BLANCO	4200K	DOW-258	111,12€
PANEL LED AT-40	60 X 120CM	UGR<19 80W - ARO BLANCO	5000K	DOW-259	111,12€

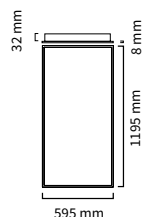

* Según la nueva normativa ERP ha habido un cambio en la medición de Lúmenes y vatios, pero sigue emitiendo la misma cantidad de luz.

A medida que vayan entrando los nuevos modelos con ERP se irá actualizando en catálogo y cajas de color.

Puede haber variación respecto la caja del producto (comprobar en ficha técnica), todos los datos en catálogo están correctos salvo error tipográfico.



PANEL LED EMPOTRADO



PANEL ULTRA SLIM



			K°	Ref	PVPR
PANEL LED ELYOS	60 X 60CM	40W - ARO BLANCO	4200K	DOW-088	39,84€

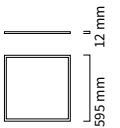

PANEL LED SAMSUNG EMPOTRADO

NEW PRICE!!



			K°	Ref	PVPR
PANEL LED AT-40	60 X 60CM	40W - ARO BLANCO	4200K	DOW-196	40,35€
PANEL LED AT-40	60 X 60CM	40W - ARO BLANCO	5000K	DOW-197	40,35€

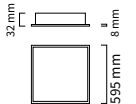

NEW PRICE!!



PANEL LED AT-40	30 X 120CM	40W - ARO BLANCO	4200K	DOW-254	48,00€
PANEL LED AT-40	30 X 120CM	40W - ARO BLANCO	5000K	DOW-255	48,00€

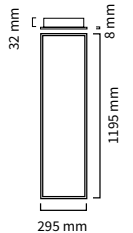

NEW PRICE!!



PANEL LED AT-40	60 X 120CM	80W - ARO BLANCO	4200K	DOW-252	99,00€
PANEL LED AT-40	60 X 120CM	80W - ARO BLANCO	5000K	DOW-253	99,00€

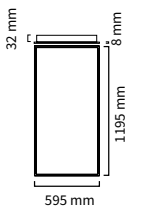

PANEL LED EMPOTRADO 3CCT



3 en 1 TRES TIPOS DE LUZ EN LA MISMA LUMINARIA

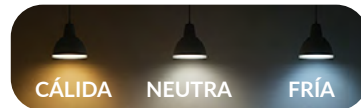

Switch 3CCT

NEW PRICE!!



PANEL LED AT-40	60 X 60CM	40W - ARO BLANCO	3CCT	DOW-282	43,50 €
-----------------	-----------	------------------	------	---------	---------

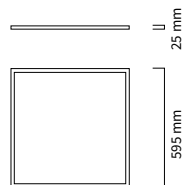

Serie Paneles superficie

ESPECIAL
COCINA

REGULACIÓN
DIMMABLE
TRIAC

DISEÑO
MINIMALISTA

Panel LED
ESPECIAL COCINA

3 POTENCIAS
20w/30w/40w

3 en 1 TRES TIPOS DE LUZ
EN LA MISMA LUMINARIA



Switch
3CCT



PANEL LED SUPERFICIE 100*1200*24mm 🌞 20 / 30 / 40w 3CCT ⚙️ DOW-319 153,69€

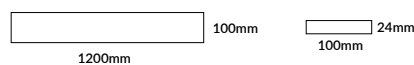

PANEL LED SUPERFICIE 3CCT

Lifud
Led Driver

3 en 1 TRES TIPOS DE LUZ
EN LA MISMA LUMINARIA



Switch
3CCT



PANEL LED 60 X 60CM CUADRADO 40W - ARO BLANCO ⚙️ 3CCT ⚙️ DOW-320 80,85€

PANEL LED 30 X 120CM RECTANGULAR 40W - ARO BLANCO ⚙️ 3CCT ⚙️ DOW-321 90,75€

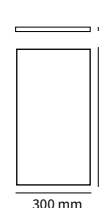
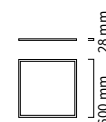

Serie Panel Domótico



Panel LED domótico



3 en 1 TRES TIPOS DE LUZ
EN LA MISMA LUMINARIA

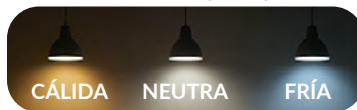

Con Mando incluido

No incluye pilas en el precio

· EMPOTRADO
· REGULABLE

COMPATIBLE CON APP **tuya**

2 MODOS DE CONTROL

WIFI + CONTROLADOR RF 2.4Ghz

PANEL LED 60 X 60CM WiFi 40W - ARO BLANCO 3CCT + RGB DOW-318 208,92€

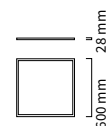

ACCESORIOS PANEL



Ref ACLED - 003
Acc. Suspensión
1 Cable
Panel 60x60 cm

PVPR 11,88€



Ref ACLED - 004
Acc. Suspensión
2 Cables
Panel 60x60 cm

PVPR 13,62€



Ref ACLED - 005
Acc. Suspensión
4 Cables
Panel 60x60 cm

PVPR 13,62€



Ref ACLED - 006
Acc. Garra
Empotrar (4u)
Panel 60x60 cm

PVPR 9,06€



Ref ACLED - 050
Perfil Empotrar
Panel 30x120 cm

Montado

PVPR 41,79€



Ref ACLED - 051
Perfil Empotrar
Panel 60x120 cm

Montado

PVPR 59,40€

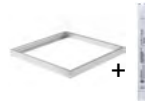

Ref ACLED - 181
Perfil Superficie
Panel 60x60 cm

INCLUIDO DRIVER SLIM
AXLED-017

PVPR 50,58€



Ref ACLED - 179
Perfil Superficie
Panel 30x120 cm

INCLUIDO DRIVER SLIM
AXLED-017

PVPR 56,22€



Ref ACLED - 180
Perfil Superficie
Panel 60x120 cm

INCLUIDO DRIVER SLIM
AXLED-017

PVPR 66,72€

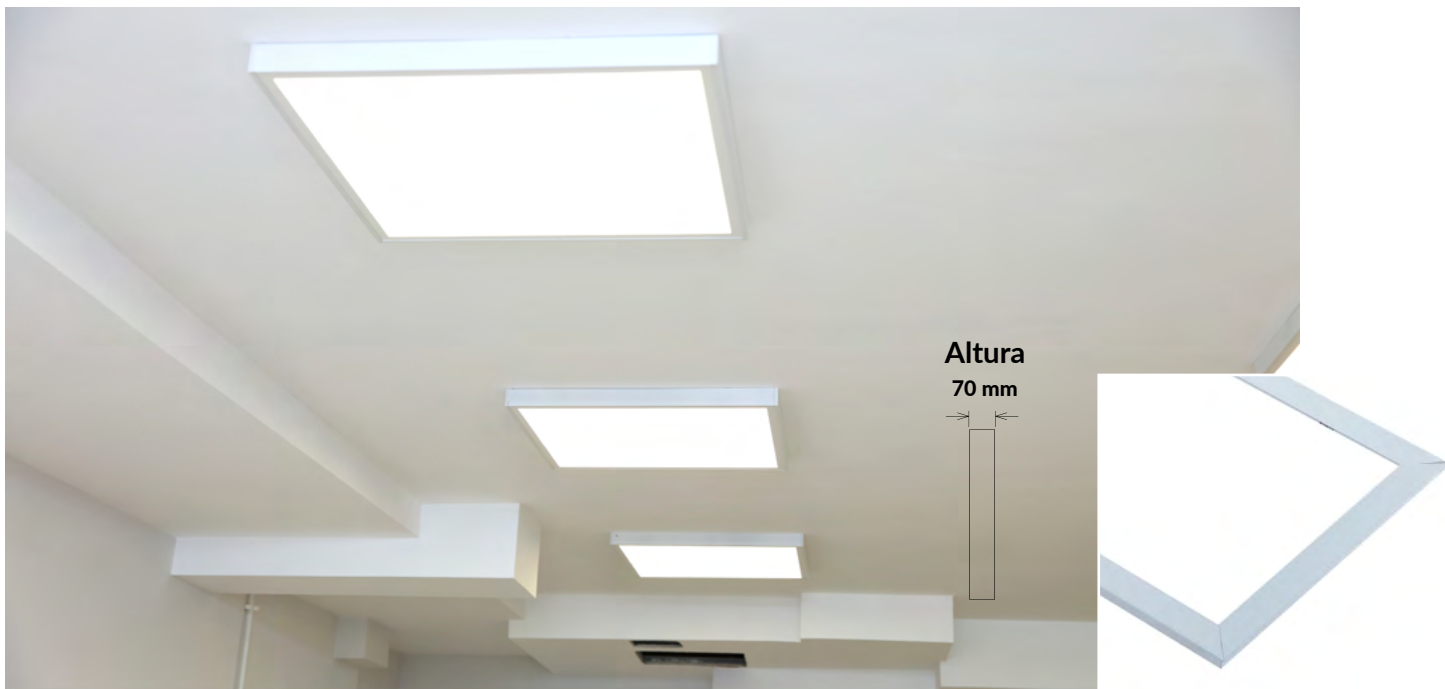

Accesorios de montaje por presión

- Montaje rápido y sencillo.

**GRAN FACILIDAD
DE MONTAJE**

**SISTEMA DE
ANCLAJE POR
PRESIÓN**

 **No necesita
tornillos**

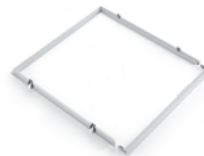
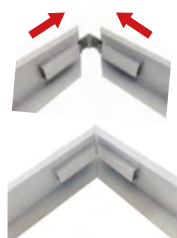

Ref ACLED - 393
Perfil Superficie
Panel 60x60 cm
Desmontado

Ref ACLED - 394
Perfil Superficie
Panel 120x30 cm
Desmontado

Ref ACLED - 395
Perfil Empotrado
Panel 60x60 cm
Desmontado

Ref ACLED - 396
Perfil Empotrado
Panel 120x30 cm
Desmontado

Ref ACLED - 398
Perfil Empotrado
Panel 120x60 cm
Desmontado

PVPR 36,18€

PVPR 41,79€

PVPR 35,94€

PVPR 41,79€

PVPR 51,36€



Accesorio cielo para panel

ACLED - 397
Perfil Marco cielo
Panel 60x60 cm

PVPR 58,26€

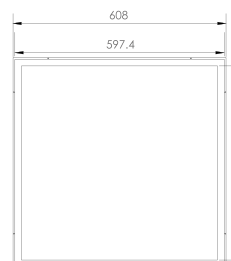



LED DRIVER



Configurable V/mA - PWM - PARA PANEL

Ref

PVPR

LED DRIVER MEANWELL LCM-60 **40W - 6 OPCIONES DE CONFIGURACIÓN** AXLED-010 141,36€



LED DRIVER REGULABLE TRIAC **PARA PANEL 40-50W** AXLED-012 47,46€



LIFUD
Led Driver



LED DRIVER REGULABLE LIFUD 0-10V **PARA PANEL 40-50W** AXLED-013 61,23€



LED DRIVER REGULABLE LIFUD 0-10V **PARA PANEL 40W** AXLED-019 50,37€



LED DRIVER LIFUD DALI PUSH **PARA PANEL 40W** AXLED-018 89,94€



LED DRIVER **PARA PANEL 40W** AXLED-014 43,17€

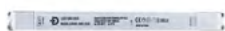

LED DRIVER SLIM **PARA PANEL AT-40 40W** AXLED-017 18,90€



PASTILLA DIMMABLE



PASTILLA PULSADOR CON EFECTO MEMORIA - FUNCIONA PARA VARIOS PULSADORES - NO DISPONE DE WIFI

PASTILLA **DIMMABLE TRIAC** POR PULSADOR **MÁX 360W** CONTR-022 52,62€

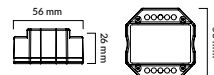

CONTR-036 CONTR-098

COMPATIBLE CON MANDO CONTR-036 Y CONTR-098

REGULACIÓN TRIAC



PASTILLA **DIMMABLE TRIAC LED** **SIN NEUTRO MÁX 250W** CONTR-083 55,02 €

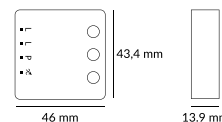

Este dimmer LED está diseñado para el control de lámparas LED regulables de hasta 250W. Con características de diseño compacto, brillo ajustable, potencia y memoria de ajuste de luz, es fácil de instalar y operar.

- Tamaño compacto
- Sin ruido
- Regulación del borde de salida
- No necesita línea neutra
- Ideal para reequipamiento
- Luminosidad y velocidad de regulación regulables
- Memoria de potencia y luminosidad

REGULACIÓN TRIAC

- REGULACIÓN TRIAC
- NO DISPONE DE WIFI
- NO APTA PARA INSTALACIONES CONMUTADAS
- SE PUEDE USAR CON PULSADORES EN PARALELO



Convierta y controle cualquier panel en **WiFi** y **WiFi regulable** con las pastillas 

COMPATIBLE CON APP **tuya**

Para más información consulte la **pág. 286**



Para interruptor simple, conmutado y cruce



			Ref	PVPR	
PASTILLA INTERRUPTOR MINI LED	WiFi	300W LED	CONTR-054	41,91€	tuya

230 V -



No apta para instalaciones conmutables

PASTILLA INTERRUPTOR MINI MULTIFUNCIÓN	WiFi	300W LED	CONTR-082	29,85€	tuya
--	------	----------	-----------	--------	-------------

230 V -



Para DOBLE interruptor, interruptor partido y conmutado

PASTILLA DOBLE INTERRUPTOR LED	WiFi	2 X 150W	CONTR-042	56,31€	tuya
--------------------------------	------	----------	-----------	--------	-------------

230 V -



Disponible para varios pulsadores



Para varios pulsadores **REGULACIÓN TRIAC** 

PASTILLA DIMMABLE TRIAC	WiFi	300W LED	WiFi	300W LED	CONTR-063	60,66€	tuya
-------------------------	------	----------	------	----------	-----------	--------	-------------

230 V -



PASTILLA TELERRUPTOR MINI WiFi	16A	230V - 300W LED	CONTR-071	45,06€	tuya
--------------------------------	-----	-----------------	-----------	--------	-------------

230 V -



NEW!



REGULACIÓN TRIAC  DIMMABLE 0-100% SIN PARPADEO

CONTROLADOR DIMMABLE TRIAC WiFi PULSADOR	WiFi	500W LED	CONTR-096	84,30€	tuya
--	------	----------	-----------	--------	-------------

230 V - · CONEXIÓN WiFi, 2,4Ghz, BLUETOOTH / CONTROL REMOTO 2,4Ghz



NEW!



			Ref	PVPR	
PASTILLA DIMMABLE TRIAC WiFi RF UART HOLE		200W	CONTR-104	58,50€	tuya

230 V -



Accesorio control remoto pulsador dimmable
CONTR-105 (No incluido)

CONTR-105	20,37€
-----------	--------



* Según la nueva normativa ERP ha habido un cambio en la medición de Lúmenes y vatios, pero sigue emitiendo la misma cantidad de luz.

A medida que vayan entrando los nuevos modelos con ERP se irá actualizando en catálogo y cajas de color.

Puede haber variación respecto la caja del producto (comprobar en ficha técnica), todos los datos en catálogo están correctos salvo error tipográfico.





Serie Tubos y Pantallas estancas

Tubo led

PROFESIONAL ESPECIAL GARAJE

Serie PREMIUM

LED DRIVER
ALTA CALIDAD



PROTECCIÓN
sobretensión

+100.000
ON/OFF



INCLUYE CEBADOR LED

TUBO LED PROSAMSUNG 9W - 600MM
TUBO LED PROSAMSUNG 9W - 600MM

4200K TUB-038 8,49€
5000K TUB-039 8,49€

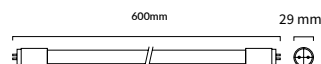

INCLUYE CEBADOR LED

TUBO LED PROSAMSUNG 18W - 1200MM
TUBO LED PROSAMSUNG 18W - 1200MM

4200K TUB-040 10,26€
5000K TUB-041 10,26€

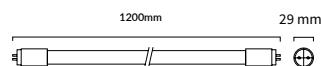

INCLUYE CEBADOR LED

TUBO LED PROSAMSUNG 22W - 1500MM
TUBO LED PROSAMSUNG 22W - 1500MM

4200K TUB-042 13,56€
5000K TUB-043 13,56€



Tubo led



INCLUYE PORTALAMPARAS - CONEXIÓN OSCILANTE - IMÁN EN LA PARTE SUPERIOR

TUBO CIRCULAR	15W - 215 x 30mm - G10q	4200K	TUB-036	18,96€
TUBO CIRCULAR	15W - 215 x 30mm - G10q	5000K	TUB-028	18,96€

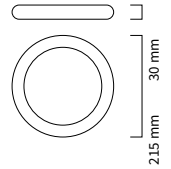

INCLUYE PORTALAMPARAS - CONEXIÓN OSCILANTE - IMÁN EN LA PARTE SUPERIOR

TUBO CIRCULAR	20W - 300 x 30mm - G10q	4200K	TUB-037	26,55€
TUBO CIRCULAR	20W - 300 x 30mm - G10q	5000K	TUB-029	20,25€

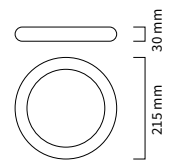

Tubo led con sensor



NEW!

BASE G13

TUBO LED RADAR SENSOR	18W	1200mm	160°	K°	Ref	PVPR
				5000K	TUB-044	15,84€

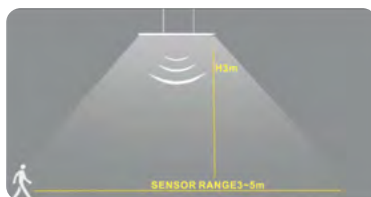
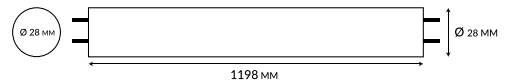

- Distancia detección hasta 5mts
- Altura 3mts
- Tiempo encendido 1min



NEW!

BASE G13

TUBO LED RADAR SENSOR	18W	1200mm	160°	K°	Ref	Ref
				5000K	TUB-045	15,69€

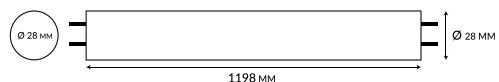

* Según la nueva normativa ERP ha habido un cambio en la medición de Lúmenes y vatios, pero sigue emitiendo la misma cantidad de luz. A medida que vayan entrando los nuevos modelos con ERP se irá actualizando en catálogo y cajas de color. Puede haber variación respecto la caja del producto (comprobar en ficha técnica), todos los datos en catálogo están correctos salvo error tipográfico.

Pantalla estanca tubo led

* NO INCLUYEN TUBO DE LED



PANTALLA ESTANCA TUBO DE LED **ABS + PC** 1 x 600

Ref **PNT - 001** PVPR 16,50€

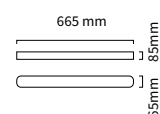

PANTALLA ESTANCA TUBO DE LED **ABS + PC** 2 x 600

Ref **PNT - 002** PVPR 19,74€

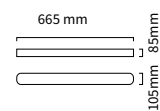

PANTALLA ESTANCA TUBO DE LED **ABS + PC** 1 x 1200

Ref **PNT - 003** PVPR 22,80€

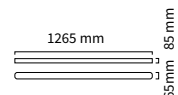

PANTALLA ESTANCA TUBO DE LED **ABS + PC** 2 x 1200

Ref **PNT - 004** PVPR 24,30€

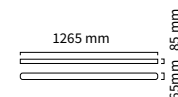

PANTALLA ESTANCA TUBO DE LED **ABS + PC** 1 x 1500

Ref **PNT - 005** PVPR 25,08€

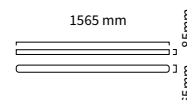

PANTALLA ESTANCA TUBO DE LED **ABS + PC** 2 x 1500

Ref **PNT - 006** PVPR 36,30€

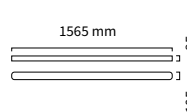

Accesorios pantalla estanca



ACCESORIO GRAPA METAL DE PANTALLA ESTANCA

Ref **ACLED-090** PVPR 0,60€



DIFUSOR **PARA PANTALLA ESTANCA LED PARA REPOSICIÓN 1200mm**

Ref **PNT-011** PVPR 11,70€

Para PNT - 004 (2 x 1200mm)

DIFUSOR **PARA PANTALLA ESTANCA LED PARA REPOSICIÓN 1500mm**

Ref **PNT-010** PVPR 11,70€

Para PNT - 006 (2 x 1500mm)

DIFUSOR **PARA PANTALLA ESTANCA LED PARA REPOSICIÓN 600mm**

Ref **PNT-015** PVPR 11,70€

Para PNT - 001 (1 x 600mm)

DIFUSOR **PARA PANTALLA ESTANCA LED PARA REPOSICIÓN 600mm**

Ref **PNT-016** PVPR 11,70€

Para PNT - 002 (2 x 600mm)



Conexión por un extremo

K°

Ref

PVPR



PANTALLA ESTANCA LED INTEGRADA

18w - 600mm

5000K

PNT-007

22,11€



Conexión por un extremo



PANTALLA ESTANCA LED INTEGRADA

35w - 1200mm

5000K

PNT-008

34,59€

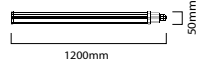

NEW!



PANTALLA ESTANCA LED INTEGRADA

50w - 1500mm

5000K

PNT-019

47,37€

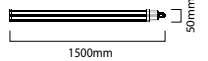

Linkable

160Lm/w



Pantalla estanca Led 1200mm

High Efficiency
120Lm/w

MENOR CONSUMO MAYOR LUMINOSIDAD

EQUIVALE A UNA PANTALLA DE DOS TUBOS DE 1500mm CON MENOR CONSUMO



Conexión por un extremo - INCLUYE TIRA LED - Compatible con kit de emergencia EMR-026

PANTALLA ESTANCA CON TIRA DE LED CON DIFUSOR 36w - 1200mm 5000K PNT-012 59,10€

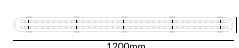

ACCESORIOS



PLACA PCB PARA PANTALLA ESTANCA 36W 1200mm 5000K PNT-013 31,20€

LED DRIVER PARA PANTALLA ESTANCA 36W 1200mm 5000K PNT-014 25,20€



High Efficiency
120Lm/w

Pantalla estanca Led 1500mm

MENOR CONSUMO MAYOR LUMINOSIDAD

LIFUD
Led Driver

LIFUD
Led Driver

Conexión por un extremo - INCLUYE TIRA LED - Compatible con kit de emergencia EMR-026

PANTALLA ESTANCA CON TIRA DE LED CON DIFUSOR 48w - 1500mm 5000K PNT-020 56,70€

48W 5760 Lm 230v 8 IP65

1500mm 103mm

NEW!



* Según la nueva normativa ERP ha habido un cambio en la medición de Lúmenes y vatios, pero sigue emitiendo la misma cantidad de luz. A medida que vayan entrando los nuevos modelos con ERP se irá actualizando en catálogo y cajas de color. Puede haber variación respecto la caja del producto (comprobar en ficha técnica), todos los datos en catálogo están correctos salvo error tipográfico.



Serie **Regletas led**

Serie Regletas - T5



3 en 1 TRES TIPOS DE LUZ
EN LA MISMA LUMINARIA

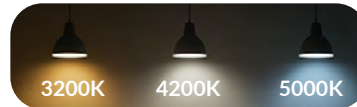

Switch
3CCT



Necesario incluir conector ACLED-469

		K°	Ref	PVPR
REGLETA LED T5	5w - 400lm - 30cm	3CCT	RGL-364	9,06€
REGLETA LED T5	10w - 900lm - 60cm	3CCT	RGL-363	10,56€
REGLETA LED T5	15w - 1500lm - 90cm	3CCT	RGL-366	11,40€
REGLETA LED T5	18w - 1800lm - 120cm	3CCT	RGL-362	16,62€



CONECTOR CABLE PARA REGLETA T5 CON INTERRUPTOR SWITCH ON/OFF	ACLED-469	2,81€
--	-----------	-------

Regleta led monocolor

LINKABLE - Conexión entre regleta y regleta.

Interruptor integrado - Cable incluido de conexión - Incluye accesorio de empalme para conexión entre regleta y regleta.



		K°	Ref	PVPR
REGLETA LED T5	4w - 300lm - 30cm	3200K	RGL-001	9,09€
REGLETA LED T5	8w - 650lm - 60cm	3200K	RGL-004	10,23€
REGLETA LED T5	12w - 900lm - 90cm	3200K	RGL-007	13,89€
REGLETA LED T5	12w - 900lm - 90cm	4200K	RGL-008	13,89€
REGLETA LED T5	12w - 900lm - 90cm	5000K	RGL-009	13,89€
REGLETA LED T5	16w - 1250lm - 120cm	3200K	RGL-010	14,73€
REGLETA LED T5	16w - 1250lm - 120cm	4200K	RGL-011	14,73€

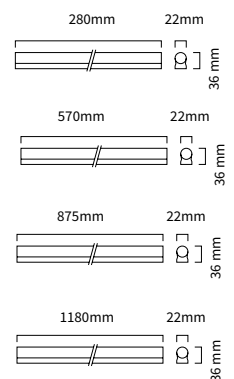

CONECTOR CABLE PARA REGLETA T5	15cm	ACLED-078	2,88€
--------------------------------	------	-----------	-------

* Según la nueva normativa ERP ha habido un cambio en la medición de Lúmenes y vatios, pero sigue emitiendo la misma cantidad de luz.

A medida que vayan entrando los nuevos modelos con ERP se irá actualizando en catálogo y cajas de color.

Puede haber variación respecto a la caja del producto (comprobar en ficha técnica), todos los datos en catálogo están correctos salvo error tipográfico.

Regleta led superficie



REGLETA LED CURVA SUPERFICIE **15w - 2800lm - 60cm** 4200K ● RGL-027 11,10€ ▼

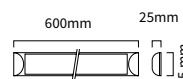

REGLETA LED PLANA SUPERFICIE **18w - 1200lm - 60cm** 4200K ● RGL-013 18,75€ ▼

REGLETA LED PLANA SUPERFICIE **18w - 1200lm - 60cm** 5000K ● RGL-014 18,75€ ▼

REGLETA LED PLANA SUPERFICIE **36w - 2200lm - 120cm** 4200K ● RGL-015 33,87€ ▼

REGLETA LED PLANA SUPERFICIE **45w - 3000lm - 150cm** 4200K ● RGL-017 38,85€ ▼

REGLETA LED PLANA SUPERFICIE **45w - 3000lm - 150cm** 5000K ● RGL-018 38,85€ ▼

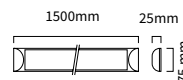
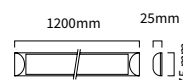
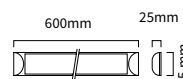



Regleta led plana superficie 3CCT

3 en 1 TRES TIPOS DE LUZ
EN LA MISMA LUMINARIA



		Ref	PVPR	
REGLETA LED PLANA SUPERFICIE	120cm 3CCT	RGL-029	35,28€	1200mm

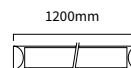

		Ref	PVPR	
REGLETA LED PLANA SUPERFICIE	150cm 3CCT	RGL-030	39,96€	1500mm

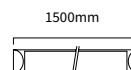

Apliques armario

ESPECIAL
ARMARIO

FÁCIL INSTALACIÓN - IMAN ADHESIVO EN LA PARTE TRASERA



Pilas no incluidas - Detección 5 metros - Tiempo encendido 20seg

REGLETA LED 24cm CON SENSOR IR	4 PILAS AAA 1,5v	K°	Ref	PVPR
REGLETA LED 24cm CON SENSOR IR	4 PILAS AAA 1,5v	3200K	RGL-019	11,94€
REGLETA LED 24cm CON SENSOR IR	4 PILAS AAA 1,5v	5000K	RGL-020	11,94€



Cable USB
incluido



Cable USB incluido - Detección 3metros - Tiempo encendido 20seg - Batería recargable 1 x 5V 450mAh

REGLETA LED 30cm CON SENSOR IR	BATERÍA USB	3200K	RGL-022	25,26€
REGLETA LED 30cm CON SENSOR IR	BATERÍA USB	5000K	RGL-021	25,26€



Sujeción magnética

Cable USB incluido - Detección 3 - 6metros - Tiempo de encendido 25seg - Batería recargable 1 x 3.7V 700mAh

APLIQUE LED ARMARIO SENSOR DE MOVIMIENTO	BATERÍA USB	3200K	APQ-015	8,88€
APLIQUE LED ARMARIO SENSOR DE MOVIMIENTO	BATERÍA USB	6500K	APQ-016	8,88€



ESPECIAL COCINA

Serie Regletas - Especial cocina

2 MODOS DE TRABAJO
ON/OFF/AUTO

3 INTENSIDADES
DE LUZ 50%/75%/100%

3 en 1 TRES TIPOS DE LUZ
EN LA MISMA LUMINARIA

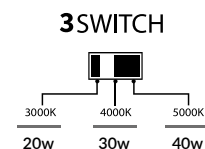
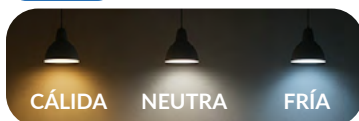

NEW!



BATERÍA USB

REGLETA CON SENSOR DE MOVIMIENTO 40CM

Ref PVPR
RGL-365 35,07€



OFF/ON/AUTO

OFF - Apagado
On - Modo continuo de luz
Auto - Modo percepción movimiento

SENSOR PIR

INDICADOR DE CARGA

INTERRUPTOR SELECTOR 3CCT

INTENSIDAD DE LUZ



GRAN AUTONOMÍA
Batería - 2000mAh



NEW!

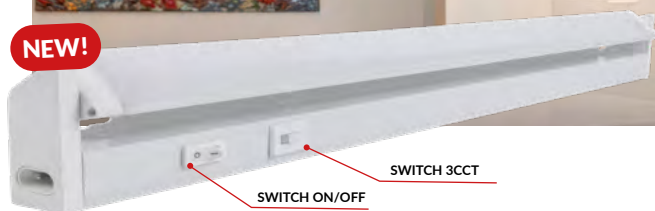

SWITCH ON/OFF

SWITCH 3CCT

REGLETA LED
ORIENTABLE 120°



3 en 1 TRES TIPOS DE LUZ
EN LA MISMA LUMINARIA

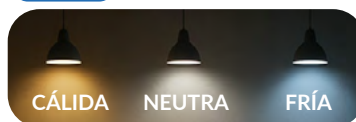

Posibilidad de conexión entre regletas.

				Ref	PVPR
REGLETA LED ORIENTABLE 120°	4W	30CM SUPERFICIE	3CCT	RGL-031	22,98€
REGLETA LED ORIENTABLE 120°	8W	55CM SUPERFICIE	3CCT	RGL-032	28,92€
REGLETA LED ORIENTABLE 120°	12W	84CM SUPERFICIE	3CCT	RGL-033	36,60€



Incluido en la caja:

- Luminaria
- Cable conexión 230v
- Cable conexión entre regletas
- Accesorios de instalación

* Según la nueva normativa ERP ha habido un cambio en la medición de Lúmenes y vatios, pero sigue emitiendo la misma cantidad de luz.

A medida que vayan entrando los nuevos modelos con ERP se irá actualizando en catálogo y cajas de color.

Puede haber variación respecto a la caja del producto (comprobar en ficha técnica), todos los datos en catálogo están correctos salvo error tipográfico.



Serie Tiras de led

GRAN VARIEDAD DE TIRAS LED

Descubre nuestras últimas incorporaciones de tiras de led. **NEW!**



Fácil, rápido y discreto

Instala tu tira de led sin necesidad de perfil protector.

Tiras de led acabado **OPAL**.

*Tira led opal - Pág-160



La tira de led más estrecha del mercado

Tiras de led **SLIM** especial muebles.

*Tira led slim - Pág-162



Se ajusta a la medida exacta de tu instalación

Tiras de led **FREE CUT**, corta por donde quieras.

*Free cut - Pág-166



Creatividad sin límites

Gran variedad y combinaciones en la misma tira de led **DIGITAL**

*Tira led digital - Pág-168

Adhesivo de Gran calidad **3M VHB**

Algunas de nuestras tiras led cuentan con el adhesivo más fuerte del mercado.

MÁXIMA CALIDAD | ULTRA FIJACIÓN



3M | VHB
ADHESIVO VHB
EXTRA FUERTE



ADHESIVO VHB DE ALTAS PRESTACIONES



EXCELENTE RESISTENCIA AMBIENTAL Y DURABILIDAD PARA EL SECTOR PROFESIONAL ELÉCTRICO



MAYOR DURABILIDAD Y ELASTICIDAD QUE EL ADHESIVO CONVENCIONAL



ADHESIVO RESISTENTE AL CALOR Y LA HUMEDAD



FÁCIL Y RÁPIDO DE INSTALAR

PIDE TU EXPOSITOR Y AÑADE LA BOBINA QUE QUIERAS

Expositor **ATMOSS** de tiras led

Expositor de bobinas de tiras LED diseñado para puntos de venta. Permite tener las tiras organizadas y visibles, facilitando el corte a medida para los clientes. Estructura robusta, ideal para mostradores o zonas de autoservicio. Mejora la presentación y agiliza la venta en almacenes eléctricos.

* Capacidad hasta 8 bobinas de tira de led.

* Consultar condiciones



Ideal para trabajos con poca luz.
Luz led incorporada

Soldador digital con batería

· Facilidad para soldar tiras led en situaciones difíciles

Soldador digital con punta fina, ideal para soldar tiras de led en situaciones difíciles

Rango de temperatura

°C 260°C - 430°C

* Punteras de repuesto

	Ref	PVPR
SOLDADOR DIGITAL CON BATERIA USB-C 3.7V 260°C-430°C	SLD-001	29,04€

Ref PVPR

NEW!



Carga por USB TIPO C

Battery Li-ion CLASE A

- CABLE INCLUIDO
- BATERÍA LI-TIO
3.7V - 1000mAh

GRAN AUTONOMÍA
Batería - 1000mAh



Batería 1000mAh

Portatil

LCD Digital

Temperatura °C

Luz de trabajo

Rápido calentamiento
Rango de temperatura 260°C - 430°C

ACCESORIOS incluidos



Estuche de almacenamiento



Resina de alta calidad para limpiar la punta



Soporte para el soldador



Cable de carga USB Tipo-C

Rodillo de goma para tira de LED

NEW!



Nuestra herramienta de **rodillo de goma para tira LED** es óptimo para profesionales que trabajan con montajes de tiras LED.

Certifica un acabado profesional y optimiza la estética general de los proyectos de iluminación interior y exterior.

Dos tamaños de rodillo de tamaño de 47mm y 41mm

	Ref	PVPR
RODILLO GOMA 6mm / 10mm CON MANGO PARA TIRA LED	ACLED-300	7,44€

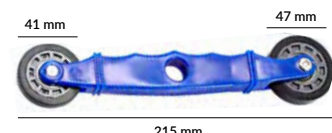
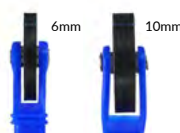



• Caja al corte

SOLO DISPONIBLE EN LAS SIGUIENTES REFERENCIAS
TIRADAS MÁXIMAS DE 25 METROS



IMPRESINDIBLE
PERFIL DISIPADOR
PARA SU INSTALACIÓN
ACLED-097



NO ES NECESARIO
PERFIL DIFUSOR
PARA SU INSTALACIÓN

Tira Led **COB 230V**



ACCESORIOS PÁG-195



Potencia	IP	Lúmenes	leds/metro	Metros	K°	Ref	PVPR
10w/m	IP65	1300Lm	560	25 Metros	2700K	TLED-158	297€
10w/m	IP65	1300Lm	560	25 Metros	3200K	TLED-159	297€
10w/m	IP65	1300Lm	560	25 Metros	4200K	TLED-160	297€
10w/m	IP65	1300Lm	560	25 Metros	5000K	TLED-161	297€



25m

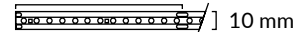

Nuevo Adhesivo posterior
3M VHB EXTRA FUERTE



Tira Led **COB 230V**

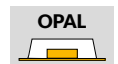

ACCESORIOS PÁG-195



Potencia	IP	Lúmenes	leds/metro	Metros	K°	Ref	PVPR
10w/m	IP65	1300Lm	560	25 Metros	2700K	TLED-152	297€
10w/m	IP65	1300Lm	560	25 Metros	3200K	TLED-153	297€
10w/m	IP65	1300Lm	560	25 Metros	4200K	TLED-154	297€
10w/m	IP65	1300Lm	560	25 Metros	5000K	TLED-155	297€



25m



Nuevo Adhesivo posterior
3M VHB EXTRA FUERTE



ACCESORIOS

- ACLED-237
- ACLED-238
- ACLED-239
- ACLED-240
- ACLED-241



Tira Led **COB 24V**



ACCESORIOS PÁG-197



Potencia	IP	Lúmenes	leds/metro	Metros	K°	Ref	PVPR
10w/m	IP20	1000Lm	320	50 Metros	3200K	TLED-093	228,60€
10w/m	IP20	1000Lm	320	50 Metros	4200K	TLED-094	228,60€



50mm

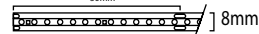

ACCESORIOS

- ACLED-208
- ACLED-211
- ACLED-207
- ACLED-212

* Según la nueva normativa ERP ha habido un cambio en la medición de Lúmenes y vatios, pero sigue emitiendo la misma cantidad de luz.

A medida que vayan entrando los nuevos modelos con ERP se irá actualizando en catálogo y cajas de color.

Puede haber variación respecto a la caja del producto (comprobar en ficha técnica), todos los datos en catálogo están correctos salvo error tipográfico.

Serie Tiras Led 230v

Tira Led COB 230V

CONEXIÓN DIRECTA

IMPRESINDIBLE
PERFIL DISIPADOR
PARA SU INSTALACIÓN
ACLED-097

TIRADAS MÁXIMAS
DE 25 METROS
CONTROLADORES
PÁG-185 WIFI

NEW!

IP65

Potencia	IP	Lúmenes	leds/metro	Metros	K°	Ref	PVPR
12w/m	IP65	1300Lm	480	50 Metros	3200K	TLED-127	447€
12w/m	IP65	1300Lm	480	50 Metros	4200K	TLED-128	447€
12w/m	IP65	1300Lm	480	50 Metros	5000K	TLED-129	447€



50m

12 mm

Nuevo Adhesivo posterior
3M VHB EXTRA FUERTE
- No es necesario rectificador



ACCESORIOS

	ACLED - 494 Enchufe conexión 12mm - P65	PVPR 7,08€		ACLED - 495 Cable 1 metro sin enchufe 12mm - P65	PVPR 8,94€		ACLED - 496 Conector TIRA - TIRA recto 12mm - P65	PVPR 1,86€
	ACLED - 497 Conector TIRA-TIRA esquina 12mm - P65	PVPR 2,61€		ACLED - 498 Tapa final 12mm - P65	PVPR 0,36€			

IP65

Potencia	IP	Lúmenes	leds/metro	Metros	K°	Ref	PVPR
12w/m	IP65	1300Lm	480	50 Metros	3200K	TLED-114	357,60€
12w/m	IP65	1300Lm	480	50 Metros	4200K	TLED-115	357,60€
12w/m	IP65	1300Lm	480	50 Metros	5000K	TLED-116	357,60€



50m

13 mm

ACCESORIOS

	ACLED - 201 Enchufe conexión 230V 12mm - P65	PVPR 7,80€		ACLED-202 Tapa final 230V COB	PVPR 0,48€		ACLED-203 Conector TIRA-TIRA	PVPR 4,50€		ACLED-204 Grapa PVC	PVPR 0,48€
--	--	----------------------	--	--	----------------------	--	---	----------------------	--	-------------------------------	----------------------

Tira Led SMD 230V

CONEXIÓN DIRECTA

IMPRESINDIBLE
PERFIL DISIPADOR
PARA SU INSTALACIÓN
ACLED-097

CONTROLADORES
PÁG-185 WIFI

NEW PRICE!!

Potencia	IP	Lúmenes	leds/metro	Metros	K°	Ref	PVPR
12w/m	IP65	1500Lm	120	50 Metros	2700K	TLED-169	495€
12w/m	IP65	1500Lm	120	50 Metros	3000K	TLED-119	495€
12w/m	IP65	1500Lm	120	50 Metros	4000K	TLED-120	495€
12w/m	IP65	1500Lm	120	50 Metros	5000K	TLED-121	495€

Corte
cada 10cm

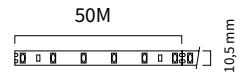

12 w/m 230 V 1500 Lm/m 1 120° - + IP 65 50 M

High Efficiency
120LEDS/ METRO

ALTA
LUMINOSIDAD

Nuevo Adhesivo posterior
3M VHB EXTRA FUERTE



ACCESORIOS

ACLED - 232 Enchufe conexión 6,21€	PVPR	ACLED - 222 Conector medio 2PIN TIRA - TIRA 1,56€	PVPR	ACLED - 220 Grapa PVC 0,24€	PVPR	ACLED - 221 Tapa final 0,24€	PVPR
		ACLED - 263 Conector L tira - tira 4,11€	PVPR				

* ENCHUFE DE CONEXIÓN INCLUIDO

NEW PRICE!!

DIMMABLE HASTA 40%

Potencia	IP	Lúmenes	leds/metro	Metros	K°	Ref	PVPR
14w/m	IP65	1300Lm	120	50 Metros	3200K	TLED-070	495€
14w/m	IP65	1300Lm	120	50 Metros	4200K	TLED-071	495€
14w/m	IP65	1300Lm	120	50 Metros	5000K	TLED-072	495€

Corte
cada 10cm



14 w/m 230 V 1300 Lm/m 1 120° - + IP 65 50 M

Nuevo Adhesivo posterior
3M VHB EXTRA FUERTE



ACCESORIOS

ACLED - 154 Enchufe conexión Tira LED 2835 230V 7,08€	PVPR	ACLED - 158 Tapa final Tira LED 2835 230V 0,54€	PVPR	ACLED - 159 Conector cable TIRA-TIRA Tira LED 2835 230V 4,20€	PVPR		
--	------	--	------	---	------	--	--

* ENCHUFE DE CONEXIÓN INCLUIDO

NEW PRICE!!

1500 Lm

Potencia	IP	Lúmenes	leds/metro	Metros	K°	Ref	PVPR
15w/m	IP65	1500Lm	120	50 Metros	3200K	TLED-457	495€
15w/m	IP65	1500Lm	120	50 Metros	4200K	TLED-458	495€
15w/m	IP65	1500Lm	120	50 Metros	5000K	TLED-459	495€

Corte
cada 5cm



15 W/m 230 V 1500 Lm/m 1 120° - + IP 65 50 M

High Efficiency
120LEDS/ METRO

ALTA
LUMINOSIDAD

ACCESORIOS

ACLED - 460 Enchufe conexión Tira LED 230V Samsung 7,08€	PVPR	ACLED - 461 Conector rápido TIRA - TIRA Samsung - 230V Monocolor 7,08€	PVPR				
---	------	---	------	--	--	--	--

* Según la nueva normativa ERP ha habido un cambio en la medición de Lúmenes y vatios, pero sigue emitiendo la misma cantidad de luz. A medida que vayan entrando los nuevos modelos con ERP se irá actualizando en catálogo y cajas de color. Puede haber variación respecto a la caja del producto (comprobar en ficha técnica), todos los datos en catálogo están correctos salvo error tipográfico.

REQUIERE ACLED-067 *Enchufe conexión Tira 041-065-042*
NO REGULABLE

NEW PRICE!!

Potencia	IP	Lúmenes	leds/metro	Metros	K°	Ref	PVPR
8w/m	IP67	603Lm	120	50 Metros	3200K	TLED-041	265,68€
8w/m	IP67	603Lm	120	50 Metros	4200K	TLED-065	265,68€
8w/m	IP67	603Lm	120	50 Metros	6500K	TLED-042	265,68€

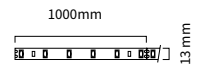

CONEXIÓN DIRECTA



ACCESORIOS

	ACLED - 070 Conector recto Tira MONOCOLOR	PVPR 1,56€		ACLED - 077 Conector 2 pin cable unión Tira Monocolor	PVPR 4,20€		ACLED - 073 Grapa PVC Tira MONOCOLOR	PVPR 0,24€		ACLED - 067 Enchufe conexión Tira MONOCOLOR	PVPR 6,21€
	CONTR - 033 Controlador LED tira MONOCOLOR <i>Máx. 80 mts.</i>	PVPR 66,12€		ACLED - 071 Tapa final Tira MONOCOLOR	PVPR 0,24€		CONTR - 034 Controlador LED tira IR 230V. MONOCOLOR <i>Máx. 50 mts.</i>	PVPR 33,24€		ACLED - 068 Conector 2 Pin Tira MONOCOLOR	PVPR 0,66€

Tira Led SMD 230V **RGB**

NEW PRICE!!

Potencia	IP	Lúmenes	leds/metro	Metros	K°	Ref	PVPR
14w/m	IP67	724Lm	120	50 Metros	RGB	TLED-043	482,94€

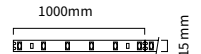

CONEXIÓN DIRECTA

ACCESORIOS

	ACLED - 072 Tapa final para Tira RGB	PVPR 0,39€		ACLED - 074 Grapa PVC Tira RGB	PVPR 0,39€		CONTR - 032 Controlador para Tira RGB CONEXIÓN POR PRESIÓN	PVPR 28,74€
	ACLED - 075 Conector 4 PIN Tira RGB	PVPR 2,73€		ACLED - 069 Conector cable Tira RGB	PVPR 4,20€		CONTR - 072 Controlador para Tira RGB CONEXIÓN POR PINCHO	PVPR 28,74€

Tira led 230V **dimmmable** con las pastillas:

2,4GHz
CONTR-022
Pastilla reguladora TRIAC
Función PUSH - 360W - Efecto memoria
52,62€

Compatible con mando

CONTR-036 **CONTR-098**

WiFi 2,4GHz **tuya**
CONTR-063
Pastilla reguladora TRIAC WIFI
Funciona para varios pulsadores - Máx 300w
60,66€

WiFi 2,4GHz Bluetooth **tuya**
CONTR-096
Pastilla reguladora TRIAC - 2,4GHz
Función PUSH - Máx 500w
84,30€

WiFi 2,4GHz **tuya**
CONTR-104
Pastilla reguladora TRIAC - 2,4GHz
Máx 150w - Accesorio no incluido **CONTR-105**
58,50€

CONTR-105
Receptor RF + Mando pulsador para **CONTR-104**
ON/OFF - Regulación
20,37€

Transporte no incluido. Para más información y descarga de fichas técnicas - www.atmoss.es -

TODOS LOS PRECIOS SON EN PVPR Y ESTÁN SUJETOS A MODIFICACIONES. LOS PRECIOS ESTÁN CORRECTOS SALVO ERROR TIPOGRÁFICO, EN ÚLTIMA INSTANCIA COMPROBAR EN TARIFA DE PRECIOS - COMPROBAR MEDIDAS CON EL ARTICULO EN FÍSICO YA QUE PUEDE HABER ERROR TIPOGRÁFICO

Tira Led Neon Flex 230V

Potencia	IP	Lúmenes	leds/metro	Metros	K°	Ref	PVPR
10w/m	IP65	800Lm	240	25 Metros	Golden 2100K	TLED-125	178,38€
10w/m	IP65	800Lm	240	25 Metros	3200K	TLED-122	178,32€
10w/m	IP65	800Lm	240	25 Metros	4200K	TLED-123	178,32€
10w/m	IP65	800Lm	240	25 Metros	6500K	TLED-124	178,32€



2500 mm

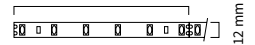

NEW!



Enchufe conexión directa incluido

ACCESORIOS

ACLED - 487
 Enchufe conexión tira led neon flex
PVPR 3,48€

ACLED - 488
 Tapa final para tira led neon flex
PVPR 0,39€

ACLED - 400
 Grapa PLS transparente
PVPR 0,39€

TLED-125 - Golden



TLED-122 -3200K



TLED-123 -4200K



TLED-124 -6500K



ACCESORIOS - PAG-196

Potencia	IP	Lúmenes	leds/metro	Metros	K°	Ref	PVPR
8w/m	IP67	800Lm	120	50 Metros	Multicolor	TLED-069	332,25€
8w/m	IP67	800Lm	120	50 Metros	RGB	TLED-086	594,33€



2500 mm

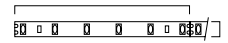

TIRA RGB NEON FLEX COMPATIBLE CON CONTROLADOR CONTR-072

ACCESORIOS

Ref ACLED - 148
 Enchufe conexión tira led neón Multicolor 230v PARA TLED-069
PVPR 11,94€

Ref ACLED - 175
 Enchufe conexión tira led neón RGB 230v PARA TLED-069
PVPR 10,38€

Ref CONTR-072
 Controlador para Tira led RGB 230v PARA TLED-086 CONEXIÓN POR PINCHO
PVPR 28,74€

Ref ACLED - 072
 Tapa final para Tira RGB
PVPR 0,39€

* Según la nueva normativa ERP ha habido un cambio en la medición de Lúmenes y vatios, pero sigue emitiendo la misma cantidad de luz. A medida que vayan entrando los nuevos modelos con ERP se irá actualizando en catálogo y cajas de color. Puede haber variación respecto a la caja del producto (comprobar en ficha técnica), todos los datos en catálogo están correctos salvo error tipográfico.

Tira Led COB OPAL

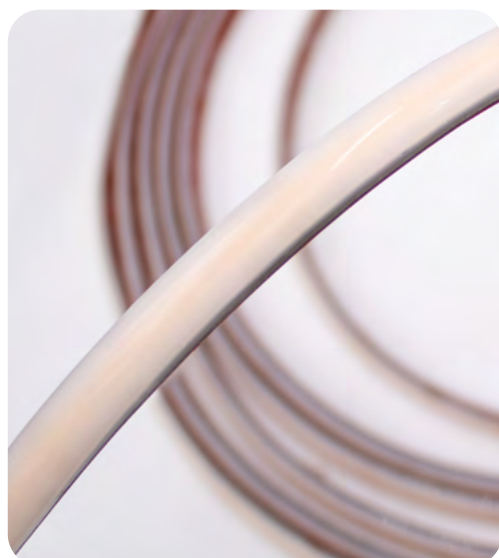
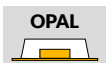

VENTAJAS

Fácil y rápida instalación:

No necesitas herramientas especiales ni estructuras adicionales. Solo retiras el adhesivo y pegas la tira donde quieras.

Menor coste:

Ahorras dinero al no tener que comprar perfiles de aluminio, difusores u otros accesorios.

Más flexibilidad en el diseño:

Las tiras pueden doblarse y adaptarse fácilmente a superficies curvas, esquinas o formas irregulares.

Menor grosor y más discreción:

Al no tener perfil, el conjunto ocupa menos espacio y se integra mejor en lugares estrechos o visibles.



Protección IP65





Tira Led COB OPAL



Tira Led COB OPAL 230V

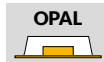

Protección silicona
BLANCO MATE

NEW!



Potencia	IP	Lúmenes	leds/metro	Metros	K°	Ref	PVPR
10w/m	IP65	1300Lm	560	25 Metros	2700K	TLED-152	297€
10w/m	IP65	1300Lm	560	25 Metros	3200K	TLED-153	297€
10w/m	IP65	1300Lm	560	25 Metros	4200K	TLED-154	297€
10w/m	IP65	1300Lm	560	25 Metros	5000K	TLED-155	297€

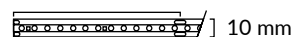

Nuevo Adhesivo posterior
3M VHB EXTRA FUERTE



ACCESORIOS

Enchufe conexión

Ref **IP65 ACLED - 237**



Conector TIRA - TIRA

Ref **IP65 ACLED - 239**



Conector ESQUINA

Ref **IP65 ACLED - 240**



Tapa FINAL

Ref **IP65 ACLED - 241**



Conector TIRA - CABLE

Ref **1,5m P65 ACLED - 238**



CONTROLADORES PÁG-168

CONTR-022, CONTR-063, CONTR-096, CONTR-104

Tira Led COB OPAL 24V

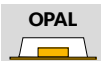

Protección silicona
BLANCO MATE

NEW!



Potencia	IP	Lúmenes	leds/metro	Metros	K°	Ref	PVPR
12w/m	IP65	1140Lm	560	5 Metros	2700K	TLED-140	48,48€
12w/m	IP65	1140Lm	560	5 Metros	3200K	TLED-141	48,48€
12w/m	IP65	1140Lm	560	5 Metros	4200K	TLED-142	48,48€
12w/m	IP65	1140Lm	560	5 Metros	5000K	TLED-143	48,48€

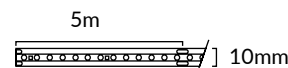

NEW PRICE!!



12w/m	IP65	1140Lm	560	50 Metros	2700K	TLED-136	470,37€
12w/m	IP65	1140Lm	560	50 Metros	3200K	TLED-137	470,37€
12w/m	IP65	1140Lm	560	50 Metros	4200K	TLED-138	470,37€
12w/m	IP65	1140Lm	560	50 Metros	5000K	TLED-139	470,37€

50m

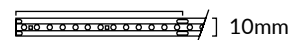

Nuevo Adhesivo posterior
3M VHB EXTRA FUERTE



ACCESORIOS

Conector TIRA-CABLE

Ref **ACLED - 502**



PVPR

4,86€

Conector ESQUINA

Ref **IP65 ACLED - 504**



PVPR

2,61€

Conector TIRA-TIRA

Ref **ACLED - 503**



PVPR

1,86€

Conector TAPA FINAL

Ref **IP65 ACLED - 505**



PVPR

0,36€

CONTROLADORES PARA TIRAS LED MONOCOLOR 24V

WIFI (CONTR-060, CONTR-097, CONTR-106) PÁG-175

NO WIFI (CONTR-029, CONTR-073, CONTR-038, CONTR-021, CONTR-012, CONTR-011, CONTR-066, CONTR-024, CONTR-058, CONTR-079, ALM-032) PÁG-176, PÁG-178

* Según la nueva normativa ERP ha habido un cambio en la medición de Lúmenes y vatios, pero sigue emitiendo la misma cantidad de luz.

A medida que vayan entrando los nuevos modelos con ERP se irá actualizando en catálogo y cajas de color.

Puede haber variación respecto a la caja del producto (comprobar en ficha técnica), todos los datos en catálogo están correctos salvo error tipográfico.

Tira Led COB 24V

IP20 | IP65 | 5M | 50M

ACCESORIOS Y CONTROLADORES PÁG - 164

NEW PRICE!!



	Potencia	IP	Lúmenes	leds/metro	Metros		K°	Ref	PVPR
IP20	10w/m	IP20	900Lm	320	5 Metros		3200K	TLED-087	23,85€
	10w/m	IP20	900Lm	320	5 Metros	↓	4200K	TLED-088	23,85€
	10w/m	IP20	900Lm	320	5 Metros		5000K	TLED-089	23,85€
IP65	10w/m	IP65	900Lm	320	5 Metros		3200K	TLED-090	35,25€
	10w/m	IP65	900Lm	320	5 Metros	↓	4200K	TLED-091	35,25€
	10w/m	IP65	900Lm	320	5 Metros		5000K	TLED-092	35,25€
IP20	10w/m	IP20	900Lm	320	50 Metros		3200K	TLED-093	228,60€
	10w/m	IP20	900Lm	320	50 Metros	↓	4200K	TLED-094	228,60€
	10w/m	IP20	900Lm	320	50 Metros		5000K	TLED-095	228,60€

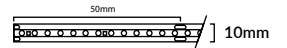
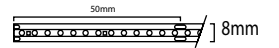

	Potencia	IP	Lúmenes	leds/metro	Metros		K°	Ref	PVPR
NEW!	10w/m	IP20	900Lm	320	5 Metros		2700K	TLED-203	21,48€
	10w/m	IP65	900Lm	320	5 Metros		2700K	TLED-204	33,24€



Nuevo Adhesivo posterior 3M VHB EXTRA FUERTE

	Potencia	IP	Lúmenes	leds/metro	Metros		K°	Ref	PVPR
IP20	12w/m	IP20	1000Lm	480	5 Metros		3200K	TLED-073	37,98€
	12w/m	IP20	1000Lm	480	5 Metros	↓	4200K	TLED-074	37,98€
	12w/m	IP20	1000Lm	480	5 Metros		5000K	TLED-075	37,98€
IP65	12w/m	IP65	1000Lm	480	5 Metros		3200K	TLED-076	49,95€
	12w/m	IP65	1000Lm	480	5 Metros	↓	4200K	TLED-077	49,95€
	12w/m	IP65	1000Lm	480	5 Metros		5000K	TLED-078	49,95€
IP20	12w/m	IP20	1000Lm	480	50 Metros		3200K	TLED-079	359,70€
	12w/m	IP20	1000Lm	480	50 Metros	↓	4200K	TLED-080	359,70€
	12w/m	IP20	1000Lm	480	50 Metros		5000K	TLED-081	359,70€

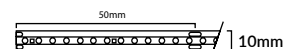
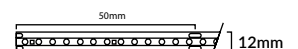

	Potencia	IP	Lúmenes	leds/metro	Metros		K°	Ref	PVPR
NEW!	12w/m	IP65	1140Lm	480	5 Metros	↓	2700K	TLED-130	46,62€



	Potencia	IP	Lúmenes	leds/metro	Metros		K°	Ref	PVPR
NEW PRICE!!	12w/m	IP65	1140Lm	480	50 Metros		3200K	TLED-131	507€
	12w/m	IP65	1140Lm	480	50 Metros	↓	4200K	TLED-132	507€
	12w/m	IP65	1140Lm	480	50 Metros		5000K	TLED-133	507€



Nuevo Adhesivo posterior 3M VHB EXTRA FUERTE

Tira led COB High Efficiency

ALTA
LUMINOSIDAD

NEW PRICE!!

	Potencia	IP	Lúmenes	leds/metro	Metros	K°	Ref	PVPR
IP20	15w/m	IP20	1500Lm	480	5 Metros	2500K	TLED-099	42,78€
	15w/m	IP20	1500Lm	480	5 Metros	3200K	TLED-096	42,78€
	15w/m	IP20	1500Lm	480	5 Metros	4200K	TLED-097	42,78€
	15w/m	IP20	1500Lm	480	5 Metros	5000K	TLED-098	42,78€
IP65	15w/m	IP65	1500Lm	480	5 Metros	3200K	TLED-100	56,01€
	15w/m	IP65	1500Lm	480	5 Metros	4200K	TLED-101	56,01€
	15w/m	IP65	1500Lm	480	5 Metros	5000K	TLED-102	56,01€
IP20	15w/m	IP20	1500Lm	480	50 Metros	3200K	TLED-103	427,95€
	15w/m	IP20	1500Lm	480	50 Metros	4200K	TLED-104	427,95€
	15w/m	IP20	1500Lm	480	50 Metros	5000K	TLED-105	427,95€

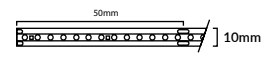
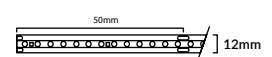
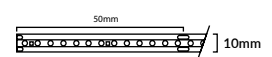

ACCESORIOS

IP 20 ACLED - 227 PVPR Conector fijo tornillo Tira-Cable IP20 10mm 2,22€	ACLED - 226 PVPR Conector fijo tornillo Tira-Tira 2P 10mm IP20 2,22€	ACLED - 228 PVPR Conector fijo tornillo Tira-Tira "T&L" 2P 10mm 3,12€	ACLED - 229 PVPR Conector invisible Tira-Tira "L" 2P 10mm IP20 1,62€	ACLED - 223 PVPR Conector rápido COB Tira-Tira IP20 c/cable 2P 10mm 5,22€	ACLED - 162 PVPR Conector rápido tira COB Tira - Tira 10mm 5 uds 6,84€
IP 20 ACLED - 208 PVPR Conector rápido LED TIRA-CABLE 2P 8MM IP20 * CON CABLE 2,70€	ACLED - 207 PVPR Conector rápido LED COB TIRA-TIRA 2-PIN 8MM IP20 24v 1,98€	ACLED - 210 PVPR Conector rápido LED TIRA-CABLE 2P 10MM IP20 * CON CABLE 2,70€	ACLED - 209 PVPR Conector rápido LED COB TIRA-TIRA 2-PIN 10MM IP20 24v 1,98€		
IP 68 ACLED - 211 PVPR Conector rápido LED COB TIRA-TIRA 2-PIN 8MM IP68 24V 4,38€	ACLED - 213 PVPR Conector rápido LED COB TIRA-TIRA 2-PIN 10MM IP68 24V 4,62€	ACLED - 212 PVPR Conector rápido LED COB TIRA-CABLE Con cable 2-PIN 8MM IP68 24V * CON CABLE 4,98€	ACLED - 214 PVPR Conector rápido LED COB TIRA-CABLE Con cable 2-PIN 10MM IP68 24V 5,22€		

CONTROLADORES PARA TIRAS LED MONOCOLOR 24V

- WIFI** (CONTR-060, CONTR-097, CONTR-106) PÁG-179
NO WIFI (CONTR-029, CONTR-073, CONTR-038, CONTR-021, CONTR-012, CONTR-011, CONTR-066, CONTR-024, CONTR-058, CONTR-079, ALM-032) PÁG-182

* Según la nueva normativa ERP ha habido un cambio en la medición de Lúmenes y vatios, pero sigue emitiendo la misma cantidad de luz. A medida que vayan entrando los nuevos modelos con ERP se irá actualizando en catálogo y cajas de color. Puede haber variación respecto a la caja del producto (comprobar en ficha técnica), todos los datos en catálogo están correctos salvo error tipográfico.

Tira Led COB 3CCT



3 en 1 TRES TIPOS DE LUZ EN LA MISMA LUMINARIA



CÁLIDA

NEUTRA

FRÍA

3CCT

NEW!

	Potencia	IP	Lúmenes	leds/metro	Metros	K°	Ref	PVPR
IP20	15w/m	IP20	1500Lm	576	5 Metros	3 CCT	TLED-106	88,29€
IP65	15w/m	IP65	1500Lm	576	5 Metros	3 CCT	TLED-107	88,29€

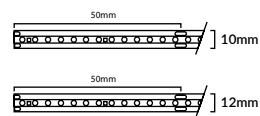

CONTROLADORES PARA TIRAS LED 3CCT 24V

WIFI - PÁG-185
CONTR-060, CONTR-097,
CONTR-108, CONTR-109,
CONTR-061, CONTR-062

NO WIFI PÁG-186, PÁG-187
CONTR-029, CONTR-027,
CONTR-073, CONTR-074,
CONTR-021, CONTR-012,
CONTR-011, CONTR-066,
CONTR-024, CONTR-058,
CONTR-079

ACCESORIOS

Ref	DESCRIPCIÓN	PVPR
ACLED - 516	CONECTOR TIRA-TIRA COB 3P IP20	0,36€
ACLED - 517	CONECTOR TIRA-CABLE 3P IP20	1,04€
ACLED - 518	CONECTOR TIRA-TIRA CABLE 3P IP20	1,38€

Serie Tiras Led COB ESPECIAL MUEBLE

ULTRA
SLIM
MUEBLES



ULTRA
SLIM
4mm
MUEBLES

Potencia	IP	Lúmenes	leds/metro	Metros	K°	Ref	PVPR
5w/m	IP20	480Lm	480	5 Metros	3200K	TLED-134	55,92€

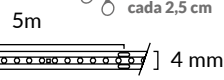

5 w/m 480 Lm/m 24V 1 120° IP 20 5 M

Nuevo Adhesivo posterior 3M VHB EXTRA FUERTE

CONTROLADORES PARA TIRAS LED MONOCOLOR 24V

WIFI - PÁG-185
CONTR-060,
CONTR-097,
CONTR-106

NO WIFI PÁG-186, PÁG-187
CONTR-029, CONTR-073,
CONTR-038, CONTR-021,
CONTR-012, CONTR-011,
CONTR-066, CONTR-024,
CONTR-058, CONTR-079

3 en 1 TRES TIPOS DE LUZ EN LA MISMA LUMINARIA

CÁLIDA NEUTRA FRÍA 3CCT

ULTRA
SLIM
5mm
MUEBLES

Potencia	IP	Lúmenes	leds/metro	Metros	K°	Ref	PVPR
9w/m	IP20	900Lm	600	5 Metros	3CCT	TLED-200	43,68€



9 w/m 900 Lm/m 24V 1 120° IP 20 5 M

CONTROLADOR PARA TIRA LED 3CCT SLIM 24V

CONTR-128



ACCESORIOS PARA TLED-134-200

ACLED - 252
CONECTOR TIRA-CABLE
2PIN - IP20 - 4mm
PVPR 1,05€

ACLED - 253
CONECTOR TIRA-TIRA
2PIN - IP20 - 4mm
PVPR 0,36€

ACLED - 254
CONECTOR TIRA-TIRA con
cable 2PIN - IP20 - 4mm
PVPR 1,38€

ULTRA
SLIM
3mm
MUEBLES

Potencia	IP	Lúmenes	leds/metro	Metros	K°	Ref	PVPR
7w/m	IP20	700Lm	400	5 Metros	2700K	TLED-201	31,92€
7w/m	IP20	700Lm	400	5 Metros	3000K	TLED-202	31,92€

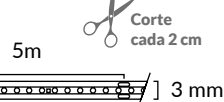

7 w/m 700 Lm/m 24V 1 120° IP 20 5 M

CONTROLADORES PARA TIRAS LED MONOCOLOR 24V

WIFI - PÁG-185
CONTR-060,
CONTR-097,
CONTR-106

NO WIFI PÁG-186, PÁG-187
CONTR-029, CONTR-073,
CONTR-038, CONTR-021,
CONTR-012, CONTR-011,
CONTR-066, CONTR-024,
CONTR-058, CONTR-079

ACCESORIOS

ACLED - 264
CONECTOR TIRA-CABLE
2PIN - IP20 - 3mm
PVPR 0,72€

ACLED - 265
CONECTOR TIRA-TIRA
2PIN - IP20 - 3mm
PVPR 0,36€

ACLED - 266
CONECTOR TIRA-TIRA con
cable 2PIN - IP20 - 3mm
PVPR 1,02€

* Según la nueva normativa ERP ha habido un cambio en la medición de Lúmenes y vatios, pero sigue emitiendo la misma cantidad de luz.

A medida que vayan entrando los nuevos modelos con ERP se irá actualizando en catálogo y cajas de color.

Puede haber variación respecto a la caja del producto (comprobar en ficha técnica), todos los datos en catálogo están correctos salvo error tipográfico.



Tira Led COB FREE CUT

Se ajusta a la medida exacta de tu instalación

NEW!

	Potencia	IP	Lúmenes	leds/metro	Metros		K°	Ref	PVPR
	12w/m	IP20	1150 Lm	576	5 Metros		2700K	TLED-174	47,04€
	12w/m	IP20	1150 Lm	576	5 Metros	↓	3200K	TLED-175	47,04€
	12w/m	IP20	1150 Lm	576	5 Metros		4000K	TLED-176	47,04€
	12w/m	IP20	1150 Lm	576	5 Metros		5000K	TLED-177	47,04€
	12w/m	IP20	1150 Lm	576	25 Metros		2700K	TLED-144	277,08€
	12w/m	IP20	1150 Lm	576	25 Metros	↓	3200K	TLED-145	277,08€
	12w/m	IP20	1150 Lm	576	25 Metros		4200K	TLED-146	277,08€
	12w/m	IP20	1150 Lm	576	25 Metros		5000K	TLED-147	277,08€
	12w/m	IP65	1150 Lm	576	25 Metros		2700K	TLED-148	346,32€
	12w/m	IP65	1150 Lm	576	25 Metros	↓	3200K	TLED-149	346,32€
	12w/m	IP65	1150 Lm	576	25 Metros		4200K	TLED-150	346,32€
	12w/m	IP65	1150 Lm	576	25 Metros		5000K	TLED-151	346,32€

 **FREE CUT**

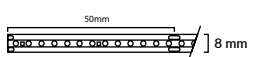







Nuevo Adhesivo posterior **3M VHB EXTRA FUERTE** 

ACCESORIOS IP20



ACLED - 233
CONECTOR TIRA-CABLE IP20
PVPR 1,04€



ACLED - 234
CONECTOR TIRA-TIRA IP20
PVPR 0,36€



ACLED - 235
CONECTOR TIRA-TIRA CABLE - IP20
PVPR 1,39€



ACLED - 236
CONECTOR FORMA "T-L" IP20
PVPR 1,74€

ACCESORIOS IP65



ACLED - 502
CONECTOR TIRA-CABLE IP65
PVPR 4,86€



ACLED - 503
CONECTOR TIRA-TIRA IP65
PVPR 1,86€



ACLED - 504
CONECTOR ESQUINA IP65
PVPR 2,61€



ACLED - 505
CONECTOR TAPA FINAL IP65
PVPR 0,36€

CONTROLADORES PARA TIRAS LED MONOCOLOR 24V

WIFI  (CONTR-060, CONTR-097, CONTR-106) PÁG-179

NO WIFI (CONTR-029, CONTR-073, CONTR-038, CONTR-021, CONTR-012, CONTR-011, CONTR-066, CONTR-024, CONTR-058, CONTR-079, ALM-032) PÁG-180, PÁG-182



Tira Led COB 24V RGB

	Potencia	IP	Lúmenes	leds/metro	Metros	K°	Ref	PVPR
IP20	14w/m	IP20	1200 Lm	576	5 Metros	RGB	TLED-117	64,14€
IP67	14w/m	IP67	1200 Lm	576	5 Metros	RGB	TLED-118	80,19€
IP20	21w/m	IP20	1600 Lm	672	25 Metros	RGB	TLED-156	311,70€
IP65	21w/m	IP65	1600 Lm	672	25 Metros	RGB	TLED-157	389,58€

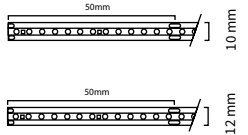
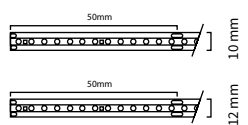

14 w/m 1200 Lm/m 24V 1 120°

Nuevo Adhesivo posterior 3M VHB EXTRA FUERTE



21 w/m 1600 Lm/m 24V 1 120°

Nuevo Adhesivo posterior 3M VHB EXTRA FUERTE



CONTROLADORES PARA TIRAS LED RGB 24V WIFI - PÁG-185 CONTR-050, CONTR-061, CONTR-062, CONTR-080

NO WIFI PÁG-186, PÁG-187 CONTR-027, CONTR-074, CONTR-039, CONTR-020, CONTR-078, CONTR-037, CONTR-049, CONTR-014, CONTR-013, CONTR-018 CONTR-065

ACCESORIOS IP20 TLED-117 - 156

ACCESORIOS IP65 TLED-118 - 157

ACLED - 242 Conector TIRA - CABLE RGB IP20 - 10mm PVPR 1,05€

ACLED - 244 Conector TIRA - TIRA con cable RGB - IP20 - 10mm PVPR 1,38€

ACLED - 243 Conector TIRA - TIRA RGB IP20 - 10mm PVPR 0,36€

ACLED - 245 Conector TIRA - CABLE cor cable RGB - IP65 PVPR 3,48€

ACLED - 247 Conector TIRA - TIRA con cable RGB - IP65 PVPR 5,52€

ACLED - 246 Conector TIRA - TIRA RGB - IP65 PVPR 1,74€

RGB + 3CCT

3 en 1 TRES TIPOS DE LUZ EN LA MISMA LUMINARIA



	Potencia	IP	Lúmenes	leds/metro	Metros	K°	Ref	PVPR
IP65	21w/m	IP20	1600 Lm	840	5 Metros	RGB+3CCT	TLED-172	95,34€

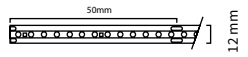

21 w/m 1600 Lm/m 24V 1 120°



Nuevo Adhesivo posterior 3M VHB EXTRA FUERTE



CONTROLADORES PARA TIRAS LED 3CCT + RGB 24V WIFI - PÁG-185 CONTR-050, CONTR-061, CONTR-062

NO WIFI PÁG-186, PÁG-187 CONTR-027, CONTR-074, CONTR-039

ACCESORIOS TLED-172

ACLED - 519 Conector TIRA - TIRA COB 6P - IP20 - 12mm PVPR 0,69€

ACLED - 520 Conector TIRA - CABLE COB 6P - IP20 - 12mm PVPR 1,38€

ACLED - 521 Conector TIRA - TIRA con cable COB 6P - IP20 - 12mm PVPR 2,08€

* Según la nueva normativa ERP ha habido un cambio en la medición de Lúmenes y vatios, pero sigue emitiendo la misma cantidad de luz. A medida que vayan entrando los nuevos modelos con ERP se irá actualizando en catálogo y cajas de color. Puede haber variación respecto a la caja del producto (comprobar en ficha técnica), todos los datos en catálogo están correctos salvo error tipográfico.

Tira Led COB DIGITAL

NEW!



IP20	Potencia	IP	Lúmenes	leds/metro	Metros	K°	Ref	PVPR
	10w/m	IP20	1150 Lm	576	5 Metros	DIGITAL 2700K - 6500K	TLED-170	83,10€



Compatible con CONTR-100
Compatible con mando CONTR-101

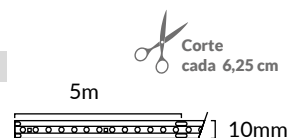

IP20	Potencia	IP	Lúmenes	leds/metro	Metros	K°	Ref	PVPR
	12w/m	IP20	1250 Lm	720	5 Metros	DIGITAL RGB	TLED-171	93,48€



Compatible con CONTR-100
Compatible con mando CONTR-101

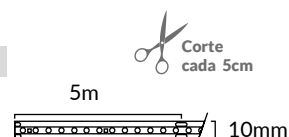

ACCESORIOS

Ref	ACLED - 516 CONECTOR TIRA-TIRA COB 3P IP20	ACLED - 517 CONECTOR TIRA-CABLE 3P IP20	ACLED - 518 CONECTOR TIRA-TIRA CABLE 3P IP20
	PVPR 0,36€	PVPR 1,04€	PVPR 1,38€



Tira Led SMD DIGITAL



Compatible con CONTR-100

IP65	Potencia	IP	Lúmenes	leds/metro	Metros	K°	Ref	PVPR
	10w/m	IP65	400 Lm	60	5 Metros	DIGITAL RGB	TLED-135	67,08€

Nuevo Adhesivo posterior
3M VHB EXTRA FUERTE



Compatible con CONTR-100
Compatible con mando CONTR-101

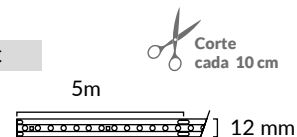

CONTROLADOR / AMPLIFICADOR TIRA LED DIGITAL



AMPLIFICADOR TIRA LED TTL **MÁX 200M**

Ref PVPR

ALM-049 69,30€

Máximo 2 tiras led digitales



AMPLIFICADOR TIRA LED TTL **6 CANALES**

Ref PVPR

ALM-050 62,34€

Máximo 6 tiras led digitales

Compatible con TLED-170-171-135



CONTROLADOR LED 8A **RGB/RGBW DIGITAL SPI**

Ref PVPR

CONTR-100 73,32€



tuya

INSTRUCCIONES

VIDEO
INSTALACIÓN

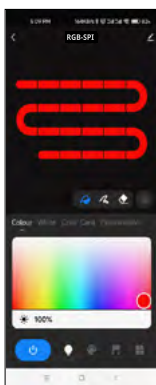

Color

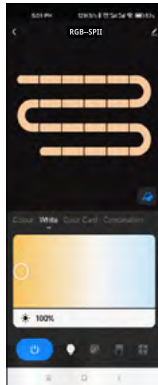

Blanco

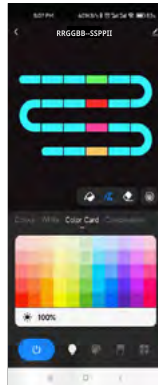

Carta de
colores

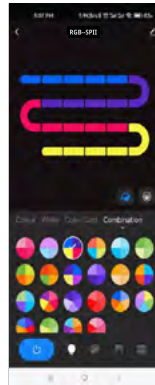

Combinación

Personaliza completamente una gran cantidad de modos de color RGB / RGBW



Ritmo musical



Escenas



Mezcla de
colores por
segmentos



Temporizador



Control por
voz



Control por
APP



16 millones
de colores



Ajuste de
brillo



PARA TIRA LED DIGITAL - Pilas CR2032 -

MANDO NEGRO CONTROLADOR RF **RGB / RGBW**

Ref PVPR

CONTR-101 48,24€



! ZONA RGB o RGBW

Tira Led SMD 24V



*Todas nuestras tiras LED son **DIMMABLES** y se pueden conectar mediante **WiFi** con su controlador correspondiente.

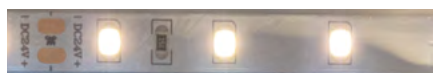

Tira LED SMD

ACCESORIOS Y CONTROLADORES PÁG - 171



*SE ACONSEJA LA INSTALACIÓN DE LAS TIRAS LED CON PERFIL DISIPADOR.



Potencia	IP	Lúmenes	leds/metro	Metros		K°	Ref	PVPR
4.8w/m	IP20	473 Lm/m	60	5 Metros		3200K	TLED-025	19,11€
4.8w/m	IP20	473 Lm/m	60	5 Metros	↓	4200K	TLED-026	19,11€
4.8w/m	IP20	473 Lm/m	60	5 Metros		5000K	TLED-027	19,11€
4.8w/m	IP67	473 Lm/m	60	5 Metros		3200K	TLED-031	29,85€
4.8w/m	IP67	473 Lm/m	60	5 Metros	↓	4200K	TLED-032	29,85€
4.8w/m	IP67	473 Lm/m	60	5 Metros		5000K	TLED-033	29,85€

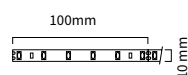
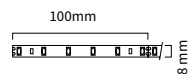

Potencia	IP	Lúmenes	leds/metro	Metros		K°	Ref	PVPR
9.6w/m	IP20	947 Lm/m	120	5 Metros		3200K	TLED-028	20,85€
9.6w/m	IP20	947 Lm/m	120	5 Metros	↓	4200K	TLED-029	20,85€
9.6w/m	IP20	947 Lm/m	120	5 Metros		6500K	TLED-030	20,85€
9.6w/m	IP67	947 Lm/m	120	5 Metros		3200K	TLED-034	37,62€
9.6w/m	IP67	947 Lm/m	120	5 Metros	↓	4200K	TLED-035	37,62€
9.6w/m	IP67	947 Lm/m	120	5 Metros		6500K	TLED-036	37,62€
9.6w/m	IP20	947 Lm/m	120	40 Metros		3200K	TLED-062	229,29€
9.6w/m	IP20	947 Lm/m	120	40 Metros	↓	4200K	TLED-063	229,29€
9.6w/m	IP20	947 Lm/m	120	40 Metros		6500K	TLED-064	229,29€
9.6w/m	IP20	947 Lm/m	120	50 Metros		3200K	TLED-082	229,29€

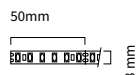
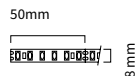
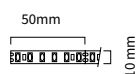
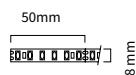

NEW PRICE!!

Potencia	IP	Lúmenes	leds/metro	Metros	K°	Ref	PVPR
14.4w/m	IP20	1250 Lm/m	60	5 Metros	3200K	TLED-008	29,70€
14.4w/m	IP20	1250 Lm/m	60	5 Metros	4200K	TLED-011	29,70€
14.4w/m	IP20	1250 Lm/m	60	5 Metros	6500K	TLED-009	29,70€
14.4w/m	IP67	1250 Lm/m	60	5 Metros	3200K	TLED-004	45,15€
14.4w/m	IP67	1250 Lm/m	60	5 Metros	4200K	TLED-012	45,15€
14.4w/m	IP67	1250 Lm/m	60	5 Metros	6500K	TLED-007	45,15€
* NO SUMERGIBLE EN EL AGUA							
14.4w/m	IP68	1250 Lm/m	60	5 Metros	3200K	TLED-044	62,85€
14.4w/m	IP68	1250 Lm/m	60	5 Metros	4200K	TLED-045	62,85€
14.4w/m	IP68	1250 Lm/m	60	5 Metros	6500K	TLED-046	62,85€
14.4w/m	IP20	1250 Lm/m	60	50 Metros	3200K	TLED-058	297,96€
14.4w/m	IP20	1250 Lm/m	60	50 Metros	4200K	TLED-059	297,96€
14.4w/m	IP20	1250 Lm/m	60	50 Metros	6500K	TLED-060	297,96€

Corte cada 10 cm

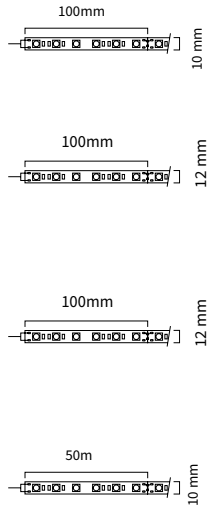

CONTROLADORES PARA TIRAS LED MONOCOLOR 24V

WIFI - PÁG-185
CONTR-060,
CONTR-097,
CONTR-106

NO WIFI PÁG-186, PÁG-187
CONTR-029, CONTR-073,
CONTR-038, CONTR-021,
CONTR-012, CONTR-011,
CONTR-066, CONTR-024,
CONTR-058, CONTR-079

ACCESORIOS IP20

Ref	ACLED - 058	ACLED - 054	ACLED - 059	ACLED - 055	ACLED - 231	ACLED - 060	ACLED - 061
	Conector Tira-Tira IP20 Monocolor 8mm	Conector Tira-Tira IP20 Monocolor 10mm	Conector Tira-Cable IP20 Monocolor 8mm	Conector Tira-Cable IP20 Monocolor 10mm	Conector rápido Tira-Cable IP20 Monocolor 10mm	Conector cable 2 hilos "I"	Conector cable 2 hilos "T"
PVPR	1,62€	1,83€	1,62€	1,83€	1,62€	2,61€	2,79€

ACCESORIOS IP65

Ref	ACLED-111	ACLED-112	ACLED-113
	Conector rápido Tira-Cable 10mm monocolor IP68	Conector rápido Tira-Tira Cable 10mm monocolor IP68	Conector rápido Tira-Tira 10mm monocolor IP68
PVPR	3,18€	4,56€	3,48€

3 en 1 TRES TIPOS DE LUZ EN LA MISMA LUMINARIA

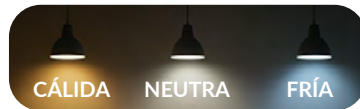

3CCT

NEW PRICE!!

* Necesario conexión con controlador para hacer el 3CCT

Potencia	IP	Lúmenes	leds/metro	Metros	K°	Ref	PVPR
8.4w/m	IP20	1100 Lm/m	60	5 Metros	3CCT	TLED-037	48,48€
8.4w/m	IP67	1100 Lm/m	60	5 Metros	3CCT	TLED-038	56,58€

Corte cada 10 cm

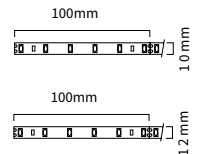

CONTROLADORES PARA TIRAS LED 3CCT 24V

WIFI - PÁG-185
CONTR-060, CONTR-097,
CONTR-108, CONTR-109,
CONTR-061, CONTR-062

NO WIFI PÁG-186, PÁG-187
CONTR-029, CONTR-027,
CONTR-073, CONTR-074,
CONTR-021, CONTR-012,
CONTR-011, CONTR-066,
CONTR-024, CONTR-058,
CONTR-079

ACCESORIOS 3CCT IP20

Ref	ACLED-267	ACLED-268	ACLED-269
	Conector rápido TIRA - TIRA con cable IP20	Conector rápido TIRA - CABLE IP20	Conector rápido TIRA - TIRA IP20
PVPR	3,27€	4,71€	3,54€

ACCESORIOS 3CCT IP68

Ref	ACLED-114	ACLED-115	ACLED-116
	Conector rápido Tira-Cable 10mm 3CCT IP68	Conector rápido Tira-Tira Cable 10mm 3CCT IP68	Conector rápido Tira-Tira 10mm 3CCT IP68
PVPR	3,27€	4,71€	3,54€

* Según la nueva normativa ERP ha habido un cambio en la medición de Lúmenes y vatios, pero sigue emitiendo la misma cantidad de luz.

A medida que vayan entrando los nuevos modelos con ERP se irá actualizando en catálogo y cajas de color.

Puede haber variación respecto a la caja del producto (comprobar en ficha técnica), todos los datos en catálogo están correctos salvo error tipográfico.

Serie Tiras Led SMD RGB / RGB + 3CCT

Tira led **SMD RGB High Efficiency**

NEW PRICE!!



Potencia	IP	Lúmenes	leds/metro	Metros	K°	Ref	PVPR
14w/m	IP20	1250 Lm/m	60	5 Metros	RGB	TLED-010	29,70€
14w/m	IP20	1250 Lm/m	60	50 Metros	RGB	TLED-061	339,42€
14w/m	IP67	1000 Lm/m	60	5 Metros	RGB	TLED-006	50,37€
14w/m	IP68	1000 Lm/m	60	5 Metros	RGB	TLED-047	62,85€

Corte cada 10 cm

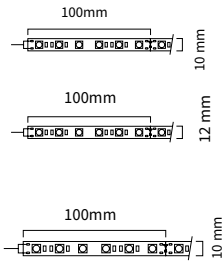

14.4 W/m

24V

1

120°

RGB

IP 20

IP 67

IP 68

50 M

5 M

NO SUMERGIBLE EN EL AGUA

ACCESORIOS TLED-010 - 061 - IP20

ACCESORIOS TLED-006 - 047 - IP65

Ref	ACLED - 056	ACLED - 057
	Conector Tira-Tira IP20 RGB 10mm	Conector Tira-Cable IP20 RGB 10mm
PVPR	2,16€	2,16€

Ref	ACLED-117	ACLED-118	ACLED-119
	Conector rápido Tira-Cable 10mm RGB IP68	Conector rápido Tira-Tira Cable 10mm RGB IP68	Conector rápido Tira-Tira 10mm RGB IP68
PVPR	3,33€	4,77€	3,75€

CONTROLADORES PARA TIRAS LED RGB 24V
WIFI - PÁG-175
CONTR-050, CONTR-061,
CONTR-062, CONTR-080

NO WIFI PÁG-176, PÁG-178
CONTR-027, CONTR-074,
CONTR-039, CONTR-020,
CONTR-078, CONTR-037,
CONTR-049, CONTR-014,
CONTR-013, CONTR-018
CONTR-065

Ref	ACLED - 205	ACLED - 206
	Conector rápido LED TIRA-CABLE 4-PIN 10MM RGB IP66	Conector rápido LED TIRA-TIRA 4-PIN 10MM RGB IP66
PVPR	3,06€	3,06€

3 en 1 TRES TIPOS DE LUZ EN LA MISMA LUMINARIA

RGB + 3CCT

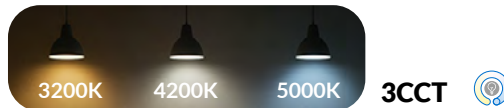

NEW PRICE!!

6 HILOS * No hay accesorios para esta tira de led



Potencia	IP	Lúmenes	leds/metro	Metros	K°	Ref	PVPR
11,2w/m	IP20	1100 Lm/m	72	5 Metros	3CCT + RGB	TLED-039	71,70€
11,2w/m	IP67	1100 Lm/m	72	5 Metros	3CCT + RGB	TLED-040	83,85€

Corte cada 16 cm

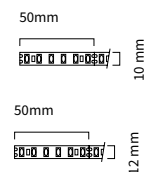

CONTROLADORES PARA TIRAS LED 3CCT + RGB 24V
WIFI - PÁG-185
CONTR-050, CONTR-061,
CONTR-062

NO WIFI PÁG-186, PÁG-187
CONTR-027,
CONTR-074,
CONTR-039



High Efficiency
240 LEDS / M



ALTA DISIPACIÓN TÉRMICA

La **Tira LED High Efficiency 24V 240 LED/m** es la elección perfecta para iluminación de cualquier espacio.

Ya que cuenta con una cantidad de **240Leds** por metro. Tiene una buena disipación de la temperatura lo que contribuye a un consumo muy poco y ahorro energético. Además cuenta con un chip **SAMSUNG** lo que hace tener una vida duradera.

21.6 w/m
3000 Lm/m
150 Lm/W
240 LEDS/M
ALTA LUMINOSIDAD

	Potencia	IP	Lúmenes	leds/metro	Metros	K°	Ref	PVPR
IP20	21.6w/m	IP20	3000 Lm/m	240	5 Metros	3000K	TLED-108	89,70€
	21.6w/m	IP20	3000 Lm/m	240	5 Metros	4000K	TLED-109	89,70€
	21.6w/m	IP20	3000 Lm/m	240	5 Metros	6000K	TLED-110	89,70€
IP20	21.6w/m	IP20	3000 Lm/m	240	5 Metros	3000K	TLED-111	107,70€
	21.6w/m	IP20	3000 Lm/m	240	5 Metros	4000K	TLED-112	107,70€
	21.6w/m	IP20	3000 Lm/m	240	5 Metros	6000K	TLED-113	107,70€

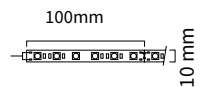

21.6 w/m
3000 Lm/m
24V
1
120°
IP 20
IP 65
5 M

Nuevo Adhesivo posterior
3M VHB EXTRA FUERTE



**CONTROLADORES
PARA TIRAS LED
MONOCOLOR 24V**

WIFI - PÁG-185
CONTR-060,
CONTR-097,
CONTR-106

NO WIFI PÁG-186, PÁG-187
CONTR-029, CONTR-073,
CONTR-038, CONTR-021,
CONTR-012, CONTR-011,
CONTR-066, CONTR-024,
CONTR-058, CONTR-079

* Según la nueva normativa ERP ha habido un cambio en la medición de Lúmenes y vatios, pero sigue emitiendo la misma cantidad de luz.

A medida que vayan entrando los nuevos modelos con ERP se irá actualizando en catálogo y cajas de color.

Puede haber variación respecto a la caja del producto (comprobar en ficha técnica), todos los datos en catálogo están correctos salvo error tipográfico.

Sensor escalera



CONTROLADOR LUZ ESCALERA CON SENSOR PIR

Ref	PVPR
CONTR-102	283,20€



32 CANALES / 1A (CANAL)

INSTRUCCIONES



VIDEO
INSTALACIÓN

Incluye:

- PIR Sensor 2Ud (1,2mts)
- Sensor de luz diurna
- Cable sensor PIR (5mts)
- Número de luces de escalera ajustable, máx. 32 peldaños
- 8 velocidades de iluminación graduadas ajustables
- 4 modos de iluminación de trabajo opcionales
- Dos controladores de luz de escalera pueden funcionar en cascada
- Control de interruptor pulsador opcional

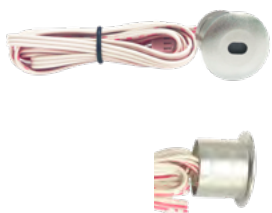

Escanea el QR para
ver el video de
instalación



CABEZAL SENSOR DE MOVIMIENTO PIR

Ref	PVPR
CONTR-103	26,82€

Serie controlador tiras led domótica

Hasta 5 canales (5 en 1), diferentes colores, con un mismo controlador en un mismo lugar

Función 5 en 1 solo en CONTR-108, 109, 061, 062

App
tuya



Convierte y controla tu instalación de tiras LED en WiFi



NEW!



PARA TIRAS MONOCOLOR

Compatible con CONTR-107 - NO INCLUIDO

* FUNCIONA CON MANDO, y APP Tuya

PASTILLA REGULACIÓN TIRA LED MONO

WIFI 10A - 240W

Ref

PVPR

CONTR-106

70,20€



tuya



Máx: 10A - 2.4GHz

* COMPATIBLE CON MANDO CONTR-107

* COMPATIBLE CON APP TUYA SMART LIFE.

48,60€



PARA TIRAS 3CCT y MONOCOLOR

* FUNCIONA CON PULSADOR, y APP Tuya

CONTROLADOR TIRA LED 3CCT

WIFI

CONTR-060

68,46€



tuya



Máx: 10.5A - 5A/CH - 2 canales - 2.4GHz

* COMPATIBLE CON APP TUYA SMART LIFE.

NEW!



PARA TIRAS 3CCT y MONOCOLOR

* FUNCIONA CON PULSADOR, Mando, y APP Tuya

CONTROLADOR TIRA LED 2 EN 1 DIM PUSH

WIFI

CONTR-095

86,40€



tuya



Máx: 30A - 30A/CH - 2.4GHz

* COMPATIBLE CON APP TUYA SMART LIFE.

* COMPATIBLE CON MANDO CONTR-030



NEW!



PARA TIRAS 3CCT y MONOCOLOR

* Funciona con Mando, y APP Tuya

CONTROLADOR WIFI 3CCT 15A

WIFI

CONTR-130

40,20€



tuya



Máx: 15A - 6A/CH - 2.4GHz

* COMPATIBLE CON APP TUYA SMART LIFE.

* COMPATIBLE CON MANDO CONTR-129



NEW!



PARA TIRAS 3CCT, RGB+W y 3CCT+RGB

* FUNCIONA CON PULSADOR, Mando, y APP Tuya

CONTROLADOR TIRA LED 5 EN 1

WIFI

CONTR-108

63,75€



tuya



Máx: 20A - 15A/CH - 5 canales - 2.4GHz

* COMPATIBLE CON APP TUYA SMART LIFE.

* COMPATIBLE CON MANDO CONTR-110



NEW!



PARA TIRAS 3CCT, RGB+W y 3CCT+RGB

* FUNCIONA CON PULSADOR, Mando, y APP Tuya

CONTROLADOR MINI TIRA LED 5 EN 1

WIFI

CONTR-109

59,85€



tuya



Máx: 10A - 6A/CH - 5 canales - 2.4GHz

* COMPATIBLE CON APP TUYA SMART LIFE.

* COMPATIBLE CON MANDO CONTR-110



PARA TIRAS 3CCT, RGB+W y 3CCT+RGB

* FUNCIONA CON APP Tuya

CONTROLADOR TIRA LED 5 EN 1

WIFI

CONTR-061

75,87€

CONTROLADOR TIRA LED 5 EN 1

WIFI - BLUETOOTH

CONTR-062

70,98€



tuya



Máx: 15A - 3A/CH - 5 canales - 2.4GHz

* COMPATIBLE CON APP TUYA SMART LIFE.

* Según la nueva normativa ERP ha habido un cambio en la medición de Lúmenes y vatios, pero sigue emitiendo la misma cantidad de luz.

A medida que vayan entrando los nuevos modelos con ERP se irá actualizando en catálogo y cajas de color.

Puede haber variación respecto a la caja del producto (comprobar en ficha técnica), todos los datos en catálogo están correctos salvo error tipográfico.



CONTROLADORES 3CCT Y RGB



PARA TIRAS 3CCT y MONOCOLOR

* FUNCIONA CON MANDO

Ref

PVPR

CONTROLADOR MiLight TIRA LED 3CCT

CONTR-029

35,07€



Máx: 10A - 20A/CH - 2 canales - 2.4GHz

* COMPATIBLE CON MANDO CONTR-030



PARA TIRAS 3CCT, RGB+W y 3CCT+RGB

* FUNCIONA CON MANDO

CONTROLADOR MiLight TIRA LED 5 EN 1

CONTR-027

49,83€



Máx: 15A - 6A/CH - 5 canales - 2.4GHz

* COMPATIBLE CON MANDO CONTR-028 (RGB Y 3CCT)
CONTR-030 (MONOCOLOR O DUAL)



PARA TIRAS 3CCT y MONOCOLOR

* FUNCIONA CON PULSADOR O CON MANDO

CONTROLADOR TIRA LED 3CCT

CONTR-073

56,10€



Máx: 20A - 20A/CH - 2 canales - 2.4GHz

* COMPATIBLE CON MANDO CONTR-030



PARA TIRAS 3CCT, RGB+W y 3CCT+RGB

* FUNCIONA CON PULSADOR O CON MANDO

CONTROLADOR TIRA LED 3CCT

CONTR-074

56,10€



Máx: 10A - 20A/CH - 5 canales - 2.4GHz

* COMPATIBLE CON MANDO CONTR-028 (RGB Y 3CCT)
CONTR-030 (MONOCOLOR O DUAL)



* COMPATIBLE CON MI-LIGHT / CONEXIÓN MICRO USB
* Sólo para dispositivos MiBoxer



CONVERTIDOR DE RF a WIFI 2,4G

CONTR-044

71,91€



Convierte un controlador de Radiofrecuencia en WIFI.



“Compatible con los principales asistentes de voz
(asistente de Google*, Amazon*, Alexa* ... etc.)”

Estas marcas son propiedad de sus respectivos propietarios,
y como tal, son reconocidas por Atmos Electric Equipment S.L
y son utilizadas únicamente con fines enunciativos.

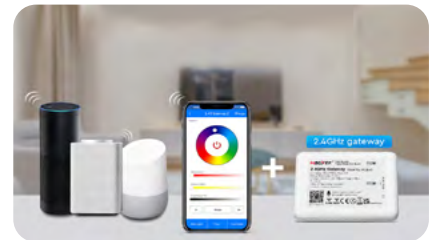

(Para controlador CONTR-027, CONTR-029, CONTR-050)

AMPLIFICADOR SEÑAL 5 CANALES

6A / CH

ALM-035

44,76 €



PASTILLA REGULADORA



Máx. 6A - Push+RF

Ref

PVPR

PASTILLA REGULADORA TIRA DE LED

MONOCOLOR

CONTR-038

54,69€



MANDO PARA PASTILLA REGULACIÓN

PARA CONTR-038

CONTR-098

47,31€



2.4GHz - 4 zonas - TIRA LED MONOCOLOR



MÁXIMO 4A - 4A POR CANAL - PUSH+RF

PASTILLA REGULADORA TIRA DE LED

RGBW / 3CCT

CONTR-039

48,78€



MANDO PARA PASTILLA REGULADORA 1 ZONA

PARA CONTR-039

CONTR-099

49,83€



2.4Ghz - 1 zona - TIRA LED RGB / 3CCT



CONTROLADORES RGB

Incluye mando con sensor infrarrojo - 6A - Mando 24 teclas
Ref
PVPR

CONTROLADOR RGB	78w	CONTR-020	14,37€
------------------------	------------	------------------	---------------

Incluye mando con sensor infrarrojo - 6A - Mando 40 teclas

CONTROLADOR RGB	78w	CONTR-078	14,37€
------------------------	------------	------------------	---------------

Incluye mando con radiofrecuencia 6A

CONTROLADOR RGB MINI RF	144W	CONTR-037	18,06€
--------------------------------	-------------	------------------	---------------

Hasta 4 tiras al mismo tiempo.

CONTROLADOR LED TIRA RGB MUSICAL 24V -	432W	CONTR-049	90,12€
---	-------------	------------------	---------------

Incluye mando con radiofrecuencia - Conexión RED RJ45

CONTROLADOR RGB MANDO SLIM RED	576W	CONTR-014	54,96€
---------------------------------------	-------------	------------------	---------------

Incluye mando con radiofrecuencia - Conexión RED RJ45

CONTROLADOR RGB MANDO TACTIL	576W	CONTR-013	72,06€
-------------------------------------	-------------	------------------	---------------

Incluye mando con radiofrecuencia - Conexión RED RJ45

CONTROLADOR RGB MANDO	576W	CONTR-018	71,49€
------------------------------	-------------	------------------	---------------

Para tiras LED 24V - 2.4GHz - Salida 6A / 4 canales

CONTROLADOR LED RGBW	24V 576W 6A 4CH	CONTR-065	81,48€
-----------------------------	------------------------	------------------	---------------



* Según la nueva normativa ERP ha habido un cambio en la medición de Lúmenes y vatios, pero sigue emitiendo la misma cantidad de luz. A medida que vayan entrando los nuevos modelos con ERP se irá actualizando en catálogo y cajas de color. Puede haber variación respecto la caja del producto (comprobar en ficha técnica), todos los datos en catálogo están correctos salvo error tipográfico.



Para tiras LED 24V Medidas: Ancho 164mm - Profundidad 65mm - Altura 40mm
Control señal: DMX512 (XLR/RJ45). Salida: 4 canales (RGBW)

	Ref	PVPR
CONTROLADOR LED DMX512 4 CANALES 8A	CONTR-119	47,25€



AMPLIFICADOR LED RGB	576W	ALM-011	39,75€
AMPLIFICADOR LED RGB NEW! 30A - 10A x 3 canales	720W	ALM-047	42,78€



CONTROLADORES MONOCOLOR / 3CCT



Incluye mando infrarrojo - Incluye conector



CONTROLADOR SLIM MONOCOLOR	144W	CONTR-021	9,78€
----------------------------	------	-----------	-------



Incluye mando codificado



CONTROLADOR MONOCOLOR	192W	CONTR-012	28,86€
-----------------------	------	-----------	--------



Incluye mando con radiofrecuencia - Mando no codificado



CONTROLADOR MONOCOLOR	600W	CONTR-011	57,60€
-----------------------	------	-----------	--------



Control remoto RF - 3 CANALES - 3CCT



CONTROLADOR LED MONOCOLOR 24V-10A * 3CH RED	CONTR-066	66,45€
---	-----------	--------

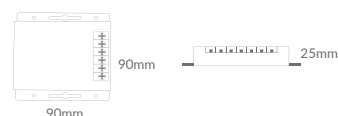

Regulación por pulsador y potenciómetro
PARA TIRAS MONOCOLOR - Hasta 4 tiras



REGULADOR I-10V 4CH x 8A	8A 4 CH	CONTR-024	173,34€
--------------------------	---------	-----------	---------



Función Push y RF 2.4Ghz - PARA TIRAS MONOCOLOR



CONTROLADOR LED DIMMABLE 24V-288W 0/1 - 10V	CONTR-058	44,76€
---	-----------	--------



Con sensor infrarrojo - Distancia detección 80mm



CONTROLADOR LED MONO 24V - 5A SENSOR Y SWITCH	CONTR-079	14,37€
---	-----------	--------



AMPLIFICADOR SEÑAL MONOCOLOR	720W	ALM-032	53,85€
------------------------------	------	---------	--------





2,4GHz

Controlador para **TLED-200**

Ref

PVPR

CONTROLADOR DUAL COLOR 24V 10A

CONTR-128

26,76€



Máx: 10A - 5A/CH - 2 canales - 2.4GHz

MANDO CONTROL REMOTO



2,4GHz - 4 Zonas Para tiras LED **MONOCOLOR** o **3CCT**

Compatible con **CONTR-029, CONTR-027, CONTR-097, CONTR-073**

Ref

PVPR

MANDO PARA CONTROLAR TIRA LED

CONTR-030

23,13€



2,4GHz - 8 Zonas Para tiras LED **RGB** y **3CCT**

Compatible con **CONTR-027, CONTR-074**

MANDO PARA CONTROLAR TIRA LED

CONTR-028

54,15€



NEW!

2,4GHz - 8 Zonas Para tiras LED **RGB** y **3CCT**

Compatible con **CONTR-108, CONTR-109**

MANDO PARA CONTROLAR TIRA LED

CONTR-110

49,56€



NEW!

PARA TLED MONOCOLOR Y DUAL COLOR

PARA CONTR-038 Y CONTR-022

RUEDA TÁCTIL - Pilas x2 AAA

Ref

PVPR

MANDO RF 4 ZONAS 3 ESCENAS **MONO / CCT**

CONTR-098

64,26€



4 ZONAS - 3 ESCENAS



NEW!

PARA TLED RGB Y RGBW

PARA CONTR-039

RUEDA TÁCTIL - Pilas x2 AAA

Ref

PVPR

MANDO RF 1 ZONAS 2 ESCENAS **RGB / RGBW**

CONTR-099

64,26€



1 ZONA - 2 ESCENAS



NEW!

PARA TLED CCT

PARA CONTR-130

RUEDA TÁCTIL - Pilas x2 AAA

Ref

PVPR

MANDO RF 4 ZONAS **CCT**

CONTR-129

23,46€



4 ZONAS



CONTROLADORES DE PARED



Para tiras 3CCT, RGB+W y 3CCT+RGB - MÁXIMO 15A

CONTROLADOR TACTIL DE PARED TIRA LED **EMPOTRABLE** CONTR-031 68,61€



Para tiras 3CCT - MÁXIMO 15A

CONTROLADOR TACTIL DE PARED TIRA LED **EMPOTRABLE** CONTR-026 61,41€



SENSORES

2,4GHz - Sensor infrarrojo 120° - 0/5metros - **45segundos**

Para tira perfil 3A - 24V

Medidas: 38x12x1.2mm



SENSOR DE MOVIMIENTO INFRARROJO MINI ACLED-132 11,22€



2,4GHz - Distancia de detección 80mm

Para tira perfil 5A - 24V **REGULABLE**

Medidas: 40x12x1.2mm



SENSOR DE MOVIMIENTO MANO IR MINI ACLED-155 7,17€



2,4GHz - POTENCIA MÁXIMA 120W

Para tira perfil 5A - 24V **REGULABLE**

Medidas: 38x12x1.2mm



CONTROLADOR TOUCH MINI CONTR-057 7,17€

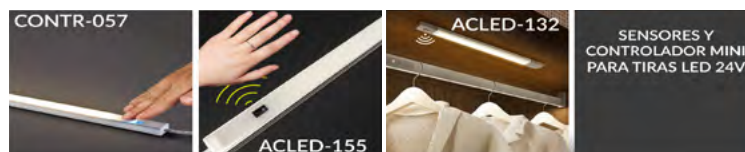



PERFILES LED DE EMPOTRAR CON

NEW PRICE!!

Perfil led - Empotrar 24V

Todos los perfiles viene incluidos las tapas finales, garras de sujeción y el difusor.

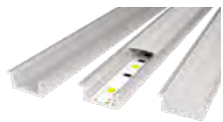

Longitud 2m Difusor OPAL

PROTECTOR ALUMINIO TIRA LED *IP44 EMPOTRAR* Ref ACLED-021 PVPR 10,08€

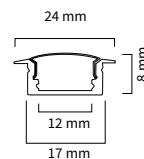

Longitud 2m Difusor OPAL

PROTECTOR ALUMINIO TIRA LED *BLANCO IP44 EMPOTRAR* Ref PRF-225 PVPR 10,50€

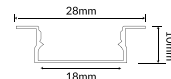

Longitud 2m Difusor OPAL

PROTECTOR ALUMINIO TIRA LED *BLANCO IP44 EMPOTRAR* Ref PRF-226 PVPR 11,52€



Longitud 2m Difusor OPAL

PROTECTOR ALUMINIO TIRA LED *IP44 EMPOTRAR* Ref PRF-221 PVPR 8,94€



Longitud 2m Difusor OPAL - Color Negro

PROTECTOR ALUMINIO NEGRO TIRA LED *IP44 EMPOTRAR* Ref ACLED-139 PVPR 11,88€

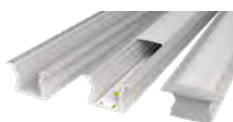
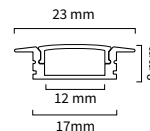

Longitud 2m Difusor OPAL

PROTECTOR ALUMINIO TIRA LED *IP44 EMPOTRAR* Ref ACLED-052 PVPR 11,55€

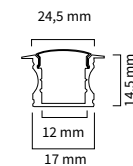

Longitud 2m Difusor OPAL

PROTECTOR ALUMINIO TIRA LED *BLANCO IP44 EMPOTRAR* Ref ACLED-153 PVPR 13,50€

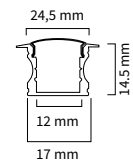

Longitud 2m Difusor OPAL - Solo para Tiras de LED IP20

PROTECTOR ALUMINIO PARA DOBLE TIRA LED IP20 *EMPOTRAR* Ref ACLED-178 PVPR 24,30€

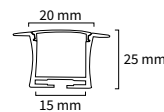

Longitud 2m Difusor OPAL

PROTECTOR ALUMINIO TIRA LED *IP44 EMPOTRAR* Ref PRF-227 PVPR 13,95€

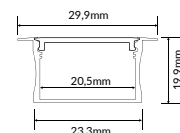

* Según la nueva normativa ERP ha habido un cambio en la medición de Lúmenes y vatios, pero sigue emitiendo la misma cantidad de luz. A medida que vayan entrando los nuevos modelos con ERP se irá actualizando en catálogo y cajas de color. Puede haber variación respecto la caja del producto (comprobar en ficha técnica), todos los datos en catálogo están correctos salvo error tipográfico.

Perfil led - Superficie 24v

Todos los perfiles viene incluidos las tapas finales, garras de sujeción y el difusor.

NEW PRICE!!

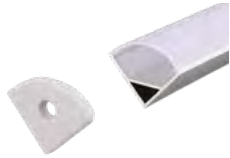

Longitud 2m Difusor OPAL

PROTECTOR ALUMINIO ANGULAR TIRA LED **SUPERFICIE**

Ref PVPR
PRF-220 8,94€

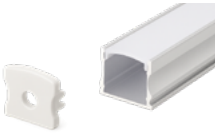
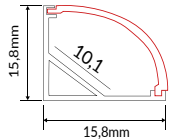

Longitud 2m Difusor OPAL

PROTECTOR ALUMINIO ANGULAR TIRA LED **SUPERFICIE**

Ref PVPR
PRF-224 10,38€

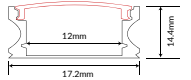

Longitud 2m Difusor OPAL

PROTECTOR ALUMINIO BLANCO TIRA LED **SUPERFICIE**

Ref PVPR
ACLED-136 11,01€

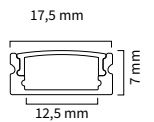

Longitud 2m Difusor OPAL

PROTECTOR ALUMINIO NEGRO TIRA LED **SUPERFICIE**

Ref PVPR
ACLED-137 11,01€

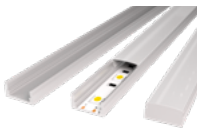
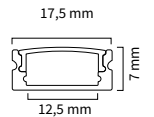

Longitud 2m Difusor OPAL

PROTECTOR ALUMINIO TIRA LED **SUPERFICIE**

Ref PVPR
ACLED-022 9,33€

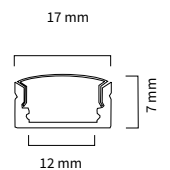

Longitud 2m Difusor OPAL

PROTECTOR ALUMINIO TIRA LED **SUPERFICIE**
PROTECTOR ALUMINIO BLANCO TIRA LED **SUPERFICIE**

Ref PVPR
ACLED-091 11,94€
ACLED-170 13,02€

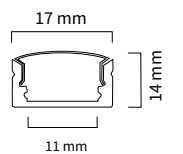



Longitud 2m Difusor OPAL

PROTECTOR ALUMINIO FLEXIBLE TIRA LED SUPERFICIE Ref ACLED-045 PVPR 6,90€

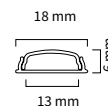

Longitud 2m Difusor OPAL

PROTECTOR ALUMINIO ANGULAR TIRA LED SUPERFICIE ACLED-023 8,94€

PROTECTOR ALUMINIO ANGULAR BLANCO TIRA LED SUPERFICIE ACLED-216 9,45€

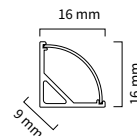

Longitud 2m

PROTECTOR ALUMINIO DISIPADOR TIRA LED SUPERFICIE ACLED-097 11,13€

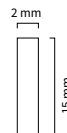

Longitud 2m Difusor OPAL

PROTECTOR ALUMINIO DOBLE TIRA LED SUPERFICIE ACLED-140 20,46€

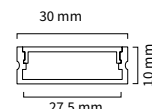

PROTECTOR ALUMINIO TIRA LED 230V - SUPERFICIE / EMPOTRAR



PROTECTOR ALUMINIO 230V TIRA LED SUPERFICIE ACLED-135 13,35€

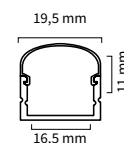

PROTECTOR ALUMINIO 230V TIRA LED SUPERFICIE PRF-222 8,94€

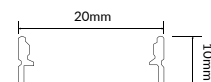

PROTECTOR ALUMINIO 230V TIRA LED EMPOTRAR PRF-223 11,01€

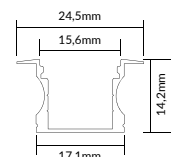

PROTECTORES DE ALUMINIO - TIRAS DE LED 24V



Ref ACLED - 038 Tapa para perfil de aluminio empotrar (2u). Para ACLED-021

Ref ACLED - 039 Tapa para perfil de aluminio superficie (2u). Para ACLED-022

Ref ACLED - 040 Tapa para perfil de aluminio angular (2u). Para ACLED-023

Ref ACLED - 095 Tapa para perfil de aluminio superficie (2u). Para ACLED-091

Ref ACLED - 096 Tapa para perfil de aluminio empotrar (2u). Para ACLED-052

Ref ACLED - 255 Tapa final l 2x5mm CON AGUJERO

Ref ACLED - 256 Tapa final l 2x5mm SIN AGUJERO

PVPR 0,72€ 0,72€ 0,72€ 0,72€ 0,72€ 0,24€ 0,24€



Ref ACLED - 041 Grapa sujeción clips enganches perfil aluminio angular

Ref ACLED - 042 Grapa sujeción clips enganches perfil aluminio superficie

Ref ACLED - 043 Grapa sujeción clips enganches perfil aluminio empotrar

Ref ACLED - 053 Difusor OPAL para perfil aluminio de Tira LED 2mts

Ref ACLED - 109 Difusor OPAL para perfil aluminio angular de Tira LED 2mts

PVPR 0,54€ 0,54€ 0,54€ 3,60€ 3,60€

* Según la nueva normativa ERP ha habido un cambio en la medición de Lúmenes y vatios, pero sigue emitiendo la misma cantidad de luz. A medida que vayan entrando los nuevos modelos con ERP se irá actualizando en catálogo y cajas de color. Puede haber variación respecto la caja del producto (comprobar en ficha técnica), todos los datos en catálogo están correctos salvo error tipográfico.



ALIMENTADOR TIRA DE LED ATMOSS® IP20 | IP67

GRAN

Calidad / Durabilidad

ALTA

Versatilidad / Disipación



COMFORT
VISUAL

Encendido y apagado
de forma progresiva

Alimentador Tira LED ATMOSS



Ref	ALM-051	ALM-053	ALM-036	ALM-037	ALM-038	ALM-039	ALM-040
	36W 24V IP20	40W 24V IP20	60W 24V IP20	100W 24V IP20	150W 24V IP20	200W 24V IP20	300W 24V IP20
PVPR	18,72€	23,46€	27,99€	38,49€	44,85€	55,98€	70,29€

IP
20



Ref	ALM-041	ALM-042	ALM-043	ALM-044	ALM-045	ALM-046
	60W 24V IP67	100W 24V IP67	150W 24V IP67	200W 24V IP67	300W 24V IP67	600W 24V IP67
PVPR	34,98€	60,42€	78,87€	87,45€	108,45€	153,90€

IP
67



ALIMENTADOR MEANWELL TIRA DE LED

Alimentador Tira LED MEANWELL



Ref	ALM-029	ALM-019	ALM-030	ALM-020	ALM-031	ALM-016	ALM-017	ALM-021
	35W 24V	50W 24V	75W 24V	100W 24V	150W 24V	200W 24V	350W 24V	600W 24V
PVPR	40,08€	41,34€	50,10€	56,34€	68,85€	91,35€	117,66€	343,05€



Tensión de salida 12V



	Ref	PVPR
Alimentador Meanwell	LRS-100-12 100W	ALM-026 63,81€
Alimentador Meanwell	LRS-100-12 200W	ALM-027 133,08€
Alimentador Meanwell	LRS-100-12 350W	ALM-028 157,83€



	Ref	PVPR
ALIMENTADOR MEANWELL LPV	35W-24V ESTANCO IP67	ALM-022 45,51€
ALIMENTADOR MEANWELL LPV	60W-24V ESTANCO IP67	ALM-023 50,10€
ALIMENTADOR MEANWELL LPV	100W-24V ESTANCO IP67	ALM-024 77,67€
ALIMENTADOR MEANWELL LPV	150W-24V ESTANCO IP67	ALM-025 110,16€



Tensión de salida 24V - Rango de entrada 100 - 305V - 10A



ALIMENTADOR MEANWELL ELG-240 - 240W	ALM-034	211,77€
-------------------------------------	---------	---------



Accesorios



ACCESORIOS TIRA LED COB 230V

COB



ACCESORIOS PARA TLED-152-153-154-155-158-159-160-161

<p>Ref Enchufe conexión IP65 ACLED - 237</p>  <p>PVPR 6,54€</p>	<p>Ref Conector TIRA - TIRA IP65 ACLED - 239</p>  <p>PVPR 1,74€</p>	<p>Ref Conector ESQUINA IP65 ACLED - 240</p>  <p>PVPR 2,46€</p>	<p>Ref Tapa FINAL IP65 ACLED - 241</p>  <p>PVPR 0,36€</p>
<p>Ref Conector TIRA - CABLE 1,5m P65 ACLED - 238</p>  <p>PVPR 8,31€</p>			

ACCESORIOS PARA TLED 126-127-128-129

<p>ACLED - 497 PVPR 2,61€</p> <p>Enchufe conexión 12mm - P65</p> 	<p>ACLED - 498 PVPR 0,36€</p> <p>Cable 1 metro sin enchufe 12mm - P65</p> 	<p>ACLED - 496 PVPR 1,86€</p> <p>Conector TIRA - TIRA recto 12mm - P65</p> 
<p>ACLED - 494 PVPR 7,08€</p> <p>Conector TIRA-TIRA esquina 12mm - P65</p> 	<p>ACLED - 495 PVPR 8,94€</p> <p>Tapa final 12mm - P65</p> 	

ACCESORIOS PARA TLED 114-115-116

<p>Necesario conexión con ACLED-201</p> <p>ACLED - 201 PVPR 7,80€</p> <p>Enchufe conexión 230V 12mm - P65</p> 	<p>ACLED-202 PVPR 0,48€</p> <p>Tapa final 230V COB</p> 	<p>ACLED-203 PVPR 4,50€</p> <p>Conector TIRA-TIRA</p> 	<p>ACLED-204 PVPR 0,48€</p> <p>Grapa PVC</p> 
<p>CONTR-077 PVPR 68,46€</p> <p>CONTROLADOR TIRA COB MONOCOLOR INFRARROJO 230V 720W MÁX 50MTS</p> 			

ACCESORIOS TIRA LED SMD 230V

SMD













ACCESORIOS PARA TLED 169-119-120-121

<p>ACLED - 232 PVPR 6,21€</p> <p>Enchufe conexión</p> 	<p>ACLED - 222 PVPR 1,56€</p> <p>Conector medio 2PIN TIRA - TIRA</p> 	<p>ACLED - 220 PVPR 0,24€</p> <p>Grapa PVC</p> 	<p>ACLED - 221 PVPR 0,24€</p> <p>Tapa final</p> 
---	---	---	--

* ENCHUFE DE CONEXIÓN INCLUIDO

ACCESORIOS PARA TLED 070-071-072

<p>ACLED - 154 PVPR 7,08€</p> <p>Enchufe conexión Tira LED 2835 230V</p> 	<p>ACLED - 126 PVPR 3,06€</p> <p>Conector para tira 3528 c/tornillos 230v MONOCOLOR</p> 	<p>ACLED - 127 PVPR 0,87€</p> <p>Tapa inicial para tira 3528 230v MONOCOLOR</p> 	<p>ACLED - 128 PVPR 0,81€</p> <p>Tapa final para tira 3528 230v MONOCOLOR</p> 
<p>ACLED - 129 PVPR 0,66€</p> <p>Cable 15cm para tira 3528 230v MONOCOLOR</p> 	<p>ACLED - 130 PVPR 2,16€</p> <p>Silicona para tira 3528 230v MONOCOLOR</p> 	<p>ACLED - 154 PVPR 7,08€</p> <p>Enchufe conexión Tira LED 2835 230V MONOCOLOR</p> 	<p>ACLED - 158 PVPR 0,54€</p> <p>Tapa final para Tira LED 2835 230V MONOCOLOR</p> 
<p>ACLED - 159 PVPR 4,20€</p> <p>Conector cable unión tira-tira Tira LED 2835 230V MONOCOLOR</p> 	<p>ACLED - 160 PVPR 0,45€</p> <p>Grapa rígida Tira LED 2835 230V MONOCOLOR</p> 	<p>CONTR - 055 PVPR 57,06€</p> <p>Controlador LED tira 2835 - 230V MONOCOLOR Máx. 50 mts.</p> 	

* Según la nueva normativa ERP ha habido un cambio en la medición de Lúmenes y vatios, pero sigue emitiendo la misma cantidad de luz.

A medida que vayan entrando los nuevos modelos con ERP se irá actualizando en catálogo y cajas de color.

Puede haber variación respecto a la caja del producto (comprobar en ficha técnica), todos los datos en catálogo están correctos salvo error tipográfico.



ACCESORIOS PARA **TLED-457-458-459**



ACLED - 460
Enchufe conexión
Tira LED 230V Samsung

PVPR
7,08€



ACLED - 461
Conector rápido TIRA - TIRA
Samsung - 230V Monocolor

PVPR
7,08€

ACCESORIOS PARA **TLED-041-065-042**



ACLED - 070
Conector recto Tira
MONOCOLOR

PVPR
1,56€



ACLED - 077
Conector 2 pin cable
unión Tira Monocolor

PVPR
4,20€



ACLED - 073
Grapa PVC Tira
MONOCOLOR

PVPR
0,24€



ACLED - 067
Enchufe conexión Tira
MONOCOLOR

PVPR
6,21€



CONTR - 033
Controlador LED tira
MONOCOLOR
Máx. 80 mts.

PVPR
66,12€



ACLED - 071
Tapa final Tira
MONOCOLOR

PVPR
0,24€



CONTR - 034
Controlador LED
tira IR 230V.
MONOCOLOR
Máx. 50 mts.

PVPR
33,24€



ACLED - 068
Conector 2 Pin Tira
MONOCOLOR

PVPR
0,66€

ACCESORIOS PARA **TLED-043**



ACLED - 072
Tapa final para
Tira RGB

PVPR
0,39€



ACLED - 074
Grapa PVC
Tira RGB

PVPR
0,39€



CONTR - 032
Controlador para
Tira RGB
CONEXIÓN POR
PRESIÓN

PVPR
28,74€



ACLED - 075
Conector 4 PIN
Tira RGB

PVPR
2,73€



ACLED - 069
Conector cable
Tira RGB

PVPR
4,20€



CONTR - 072
Controlador para
Tira RGB
CONEXIÓN POR
PINCHO

PVPR
28,74€

ACCESORIOS TIRA LED 230V

NEON FLEX



ACCESORIOS PARA **TLED-125-122-123-124**



ACLED - 487
Enchufe conexión
tira led neon flex

PVPR
3,48€



ACLED - 488
Tapa final para
tira led neon flex

PVPR
0,39€



ACLED - 400
Grapa PLS
transparente

PVPR
0,39€

ACCESORIOS PARA **TLED-069-086**



ACLED - 148
Enchufe conexión
tira led neón
Multicolor 230v
PARA TLED-069

PVPR
11,94€



ACLED - 175
Enchufe conexión
tira led neón
RGB 230v
PARA TLED-069

PVPR
10,38€



CONTR-072
Controlador para
Tira led
RGB 230v
PARA TLED-086
CONEXIÓN POR PINCHO

PVPR
28,74€



ACLED - 072
Tapa final para
Tira RGB

PVPR
0,39€

ACCESORIOS TIRA LED 230V

COB OPAL



ACCESORIOS PARA **TLED-152-153-154-155**

Ref

Enchufe conexión
IP65 ACLED - 237



PVPR 6,54€

Conector TIRA - TIRA
IP65 ACLED - 239



PVPR 1,74€

Conector ESQUINA
IP65 ACLED - 240



PVPR 2,46€

Tapa FINAL
IP65 ACLED - 241



PVPR 0,36€

Ref

Conector TIRA - CABLE
1,5m P65 ACLED - 238



PVPR 8,31€



ACCESORIOS PARA **TLED-140-141-142-143-136-137-138-139**

Conector **TIRA-CABLE**
Ref **ACLED - 502**
PVPR **4,86€**



Conector **ESQUINA**
IP65 Ref **ACLED - 504**
PVPR **2,61€**



Conector **TIRA-TIRA**
Ref **ACLED - 503**
PVPR **1,86€**



Conector **TAPA FINAL**
IP65 Ref **ACLED - 505**
PVPR **0,36€**



ACCESORIOS **TIRA LED COB 24V**

COB

IP 20

Ref **ACLED - 227**
Conector fijo
tornillo Tira-Cable
IP20 10mm



PVPR **2,22€**

Ref **ACLED - 226**
Conector fijo
tornillo Tira-Tira
2P 10mm IP20



PVPR **2,22€**

Ref **ACLED - 228**
Conector fijo
tornillo Tira-Tira
"T&L" 2P 10mm



PVPR **3,12€**

Ref **ACLED - 229**
Conector invisible
Tira-Tira "L"
2P 10mm IP20

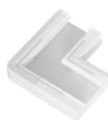

PVPR **1,62€**

Ref **ACLED - 223**
Conector rápido
COB Tira-Tira **IP20**
c/cable **2P 10mm**



PVPR **5,22€**

Ref **ACLED - 162**
Conector rápido
tira COB Tira - Tira
10mm 5 uds



PVPR **6,84€**

IP 20

Ref **ACLED - 208**
*** CON CABLE**
Conector
rápido LED
TIRA-CABLE
2P 8MM IP20



PVPR **2,70€**

Ref **ACLED - 207**
Conector
rápido LED COB
TIRA-TIRA
2-PIN 8MM IP20 24v



PVPR **1,98€**

Ref **ACLED - 210**
*** CON CABLE**
Conector
rápido LED
TIRA-CABLE
2P 10MM IP20



PVPR **2,70€**

Ref **ACLED - 209**
Conector
rápido LED COB
TIRA-TIRA
2-PIN 10MM IP20 24v



PVPR **1,98€**

Sellar juntas con silicona para una mayor protección.

IP 68

Ref **ACLED - 211**
Conector rápido LED
COB TIRA-TIRA
2-PIN 8MM IP68
24V



PVPR **4,38€**

Ref **ACLED - 213**
Conector rápido LED
COB TIRA-TIRA
2-PIN 10MM
IP68 24V



PVPR **4,62€**

Ref **ACLED - 212**
Conector *** CON CABLE**
rápido LED COB
TIRA-CABLE Con cable
2-PIN 8MM IP68
24V

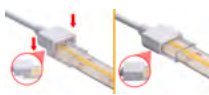

PVPR **4,98€**

Ref **ACLED - 214**
Conector *** CON CABLE**
rápido LED COB
TIRA-CABLE Con cable
2-PIN 10MM IP68
24V

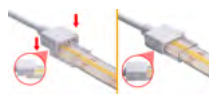

PVPR **5,22€**

ACCESORIOS PARA **TLED 130 - 131 - 132 - 133**

IP 65

Ref **ACLED - 502**
Conector Cob
Tira-Cable
300mm - IP65



PVPR **4,86€**

Ref **ACLED - 158**
Tapa final para
Tira led - **IP65**



PVPR **0,54€**

Ref **ACLED - 503**
Conector Cob
Tira-Tira recto
10mm - IP65



PVPR **1,86€**

Ref **ACLED - 504**
Conector Cob
Tira-Tira esquina
10mm - IP65



PVPR **2,61€**

**ACCESORIOS TIRA LED SLIM COB 24V****SLIM COB** **ACCESORIOS PARA TLED-134-200**



ACLED - 252
CONECTOR TIRA-CABLE
2PIN - IP20 - 4mm
PVPR 1,05€



ACLED - 253
CONECTOR TIRA-TIRA
2PIN - IP20 - 4mm
PVPR 0,36€



ACLED - 254
CONECTOR TIRA-TIRA con
cable 2PIN - IP20 - 4mm
PVPR 1,38€

ACCESORIOS PARA TLED-201-202

ACLED - 264
CONECTOR TIRA-CABLE
2PIN - IP20 - 3mm



ACLED - 265
CONECTOR TIRA-TIRA
2PIN - IP20 - 3mm



ACLED - 266
CONECTOR TIRA-TIRA con
cable 2PIN - IP20 - 3mm

ACCESORIOS TIRA LED COB 24V**FREE CUT COB** **ACCESORIOS PARA TLED-174-175-176-177-144 - 145 - 146 - 147**



ACLED - 233
CONECTOR
TIRA-CABLE
IP20
PVPR 1,04€



ACLED - 234
CONECTOR
TIRA-TIRA
IP20
PVPR 0,36€



ACLED - 235
CONECTOR
TIRA-TIRA
CABLE - IP20
PVPR 1,39€



ACLED - 236
CONECTOR
FORMA "T-L"
IP20
PVPR 1,74€

ACCESORIOS PARA TLED 136 - 137 - 138 - 139 - 140 - 141 - 142 - 143



ACLED - 502
CONECTOR
TIRA-CABLE
IP65
PVPR 4,86€



ACLED - 503
CONECTOR
TIRA-TIRA
IP65
PVPR 1,86€



ACLED - 504
CONECTOR
ESQUINA
IP65
PVPR 2,61€



ACLED - 505
CONECTOR
TAPA FINAL
IP65
PVPR 0,36€

ACCESORIOS TIRA LED COB 24V**COB RGB****ACCESORIOS PARA TLED 117-156**



ACLED - 242
Conector
TIRA - CABLE RGB
IP20 - 10mm
PVPR 1,05€



ACLED - 230
Conector invisible
Tira-Tira Recto
4P 10mm IP20
PVPR 1,80€



ACLED - 243
Conector
TIRA - TIRA RGB
IP20 - 10mm
PVPR 0,36€



ACLED - 244
Conector
TIRA - TIRA con cable
RGB - IP20 - 10mm
PVPR 1,38€



ACLED - 225
Conector rápido
RGB Tira-Cable IP20
c/cable 4P 10mm
PVPR 4,56€



ACLED - 224
Conector rápido
RGB Tira-Tira IP20
c/cable 4P 10mm
PVPR 7,32€

ACCESORIOS PARA TLED 118-157



ACLED - 245
Conector
TIRA - CABLE con
cable RGB - IP65
PVPR 3,48€



ACLED - 246
Conector
TIRA - TIRA
RGB - IP65
PVPR 1,74€



ACLED - 247
Conector
TIRA - TIRA con
cable RGB - IP65
PVPR 5,52€



ACCESORIOS TIRA LED DIGITAL 24V

DIGITAL



ACCESORIOS PARA TLED-170-171

COB DIGITAL



ACLED - 516
CONECTOR TIRA-TIRA COB
3P IP20

PVPR 0,36€



ACLED - 517
CONECTOR TIRA-CABLE
3P IP20

PVPR 1,04€



ACLED - 518
CONECTOR TIRA-TIRA CABLE
3P IP20

PVPR 1,38€

ACCESORIOS PARA TLED-135

SMD DIGITAL



ACLED - 249
CONECTOR TIRA-CABLE
4PIN - IP64 - 10mm

PVPR 3,72€



ACLED - 250
CONECTOR TIRA-TIRA
4PIN - IP64 - 10mm

PVPR 1,86€



ACLED - 251
CONECTOR TIRA-TIRA con cable
4PIN - IP64 - 10mm

PVPR 5,91€

CONECTOR TIRA LED MONOCOLOR



Ref

ACLED - 058
Conector
Tira-Tira IP20
Monocolor 8mm

ACLED - 054
Conector
Tira-Tira IP20
Monocolor 10mm

ACLED - 059
Conector
Tira-Cable IP20
Monocolor 8mm

ACLED - 055
Conector
Tira-Cable IP20
Monocolor 10mm

ACLED - 231
Conector rápido
Tira-Cable IP20
Monocolor 10mm

ACLED - 060
Conector cable
2 hilos "I"

ACLED - 061
Conector cable
2 hilos "T"

PVPR

1,62€

1,83€

1,62€

1,83€

1,62€

2,61€

2,79€



Ref

ACLED-111
Conector rápido
Tira-Cable 10mm
monocolor IP68

ACLED-112
Conector rápido
Tira-Tira Cable 10mm
monocolor IP68

ACLED-113
Conector rápido
Tira-Tira 10mm
monocolor IP68

PVPR

3,18€

4,56€

3,48€

CONECTOR TIRA LED 3CCT



ACCESORIOS PARA TLED 037

Ref ACLED-267
Conector rápido
TIRA - TIRA con cable
IP20

TLED-037

Ref ACLED-268
Conector rápido
TIRA - CABLE
IP20

TLED-037

Ref ACLED-269
Conector rápido
TIRA - TIRA
IP20

TLED-037

PVPR

3,27€

4,71€

3,54€

ACCESORIOS PARA TLED 038

Ref ACLED-114
Conector rápido
Tira-Cable 10mm
3CCT IP68

TLED-038

Ref ACLED-115
Conector rápido
Tira-Tira Cable
10mm 3CCT IP68

TLED-038

Ref ACLED-116
Conector rápido
Tira-Tira 10mm
3CCT IP68

TLED-038

PVPR

3,27€

4,71€

3,54€

* Según la nueva normativa ERP ha habido un cambio en la medición de Lúmenes y vatios, pero sigue emitiendo la misma cantidad de luz.

A medida que vayan entrando los nuevos modelos con ERP se irá actualizando en catálogo y cajas de color.

Puede haber variación respecto a la caja del producto (comprobar en ficha técnica), todos los datos en catálogo están correctos salvo error tipográfico.



ACCESORIOS - TIRAS DE LED 24V

SMD

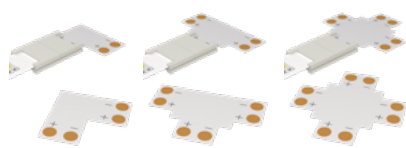

UNIÓN SOLDABLE TIRA LED **MONOCOLOR**

MONO
COLOR



	Ref	PVPR
UNIÓN SOLDABLE TIRA DE LED MONOCOLOR "L"	ACLED-019	1,20€
UNIÓN SOLDABLE TIRA DE LED MONOCOLOR "T"	ACLED-017	1,20€
UNIÓN SOLDABLE TIRA DE LED MONOCOLOR "X"	ACLED-015	1,20€

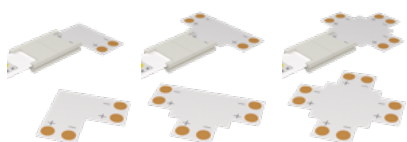

UNIÓN SOLDABLE TIRA LED **RGB**

RGB



UNIÓN SOLDABLE TIRA DE LED RGB "L"	ACLED-020	1,20€
UNIÓN SOLDABLE TIRA DE LED RGB "T"	ACLED-018	1,20€
UNIÓN SOLDABLE TIRA DE LED RGB "X"	ACLED-016	1,20€

CONECTOR TIRA LED **RGB**

RGB

SMD



IP
20



ACCESORIOS PARA **TLED 010 - 061**



Ref	ACLED - 056	ACLED - 057
	Conector	Conector
	Tira-Tira IP20	Tira-Cable IP20
	RGB 10mm	RGB 10mm

PVPR	2,16€	2,16€
------	-------	-------



IP
68



ACCESORIOS PARA **TLED 006 - 047**



ACLED-117	ACLED-118	ACLED-119	ACLED - 205	ACLED - 206
Conector rápido	Conector rápido	Conector rápido	Conector rápido LED	Conector rápido LED
Tira-Cable 10mm	Tira-Tira Cable 10mm	Tira-Tira 10mm	TIRA-CABLE	TIRA-TIRA
RGB IP68	RGB IP68	RGB IP68	4-PIN 10MM RGB IP66	4-PIN 10MM RGB IP66

3,33€	4,77€	3,75€	3,06€	3,06€
-------	-------	-------	-------	-------



Ref	ACLED - 001 <i>Grapa de plástico para Tira de LED IP67</i>	ACLED - 002 <i>Tapá final para Tira de LED IP67</i>	ACLED - 105 <i>Tubo termorretractil transparente Ø15mm - 1mts.</i>	ACLED - 467 <i>Tubo termorretractil negro Ø15mm - 1mts.</i>
PVPR	0,39€	0,39€	17,70€	17,70€

CABLES



Ref	ACLED - 062 <i>Cable 2 hilos 0.52 para conexiones LED</i>	ACLED - 063 <i>Cable 4 hilos 0.34 para conexiones LED</i>	ACLED - 064 <i>Cable 5 hilos 0.34 para conexiones LED</i>	ACLED - 215 <i>Cable 6 HILOS 0.34 Para conexiones led 15cm</i>	ACLED - 156 <i>Cable alimentación DC hembra 5,5 blanco</i>	ACLED - 157 <i>Cable alimentación DC macho 5,5 blanco</i>
PVPR	0,45€	0,60€	0,87€	1,38€	1,59€	1,59€





Serie **Proyector exterior**



PROYECTOR MINI **MINI** DE ALTA POTENCIA LUMÍNICA **SLIM**

DIMMABLE

3 en 1 TRES TIPOS DE LUZ
EN LA MISMA LUMINARIA



CAMBIO DE COLOR DE LUZ
CON **CONTROL REMOTO**

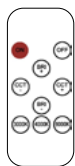

MANDO INCLUIDO



PROYECTOR SMD BLACKBODY MANDO y MEMORIA.
50W 3CCT IP65 PRY-141 - 67,32€



PRY-141

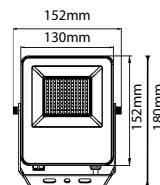

PROYECTOR SMD BLACKBODY MANDO y MEMORIA.
100W 3CCT IP65 PRY-142 - 113,40€



PRY-142

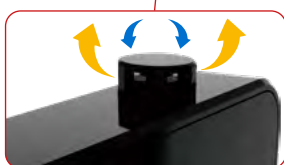
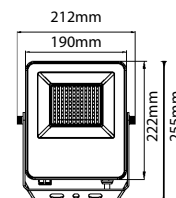

Válvula anticondensación

Equilibra la diferencia de presión de aire entre el interior y el exterior de la lámpara para evitar la condensación.

NEW!



LENTES PRISMÁTICAS

ALTA
LUMINOSIDAD

185
Lm/w

High Efficiency
185Lm/w

500 W **PROYECTOR EXTERIOR**
DE ALTA POTENCIA LUMÍNICA

Ideal para iluminar grandes espacios

LIFUD
Led Driver

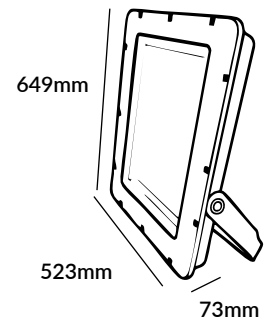

PROYECTOR EXTERIOR LED	NEW!	500W IP65	K°	Ref	PVPR
			5000K	PRY-447	669,45€

- 500 W
- 80000 Lm
- 230 V
- 1
- 120°
- IP 65
- >0,9 FP
- ↓

PROYECTOR EXTERIOR Alta luminosidad



300 W **ALTA** **185** **High Efficiency**
LUMINOSIDAD Lm/w 185Lm/w

PROYECTOR EXTERIOR LED	300W IP65	K°	Ref	PVPR
		4200K	PRY-445	249,18€
		5000K	PRY-446	249,18€

- 300 W
- 55500 Lm
- 230 V
- 4
- 120°
- IP 65
- >0,9 FP
- ↓

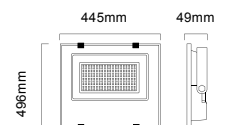

* Según la nueva normativa ERP ha habido un cambio en la medición de Lúmenes y vatios, pero sigue emitiendo la misma cantidad de luz. A medida que vayan entrando los nuevos modelos con ERP se irá actualizando en catálogo y cajas de color. Puede haber variación respecto a la caja del producto (comprobar en ficha técnica), todos los datos en catálogo están correctos salvo error tipográfico.



PROYECTOR EXTERIOR *Alta luminosidad*



High Efficiency
160Lm/w

ROTACIÓN
360°



			K°	Ref	PVPR
PROYECTOR EXTERIOR	30W IP65	NEW!	3200K	PRY-439	42,90€
PROYECTOR EXTERIOR	30W IP65		4200K	PRY-124	42,90€
PROYECTOR EXTERIOR	30W IP65		5000K	PRY-106	42,90€

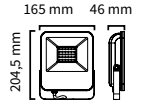

PROYECTOR EXTERIOR	50W IP65		3200K	PRY-125	66,72€
PROYECTOR EXTERIOR	50W IP65		4200K	PRY-126	66,72€
PROYECTOR EXTERIOR	50W IP65		5000K	PRY-107	66,72€

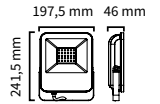

PROYECTOR EXTERIOR	100W IP65	NEW!	3200K	PRY-418	108,57€
--------------------	-----------	------	-------	---------	---------

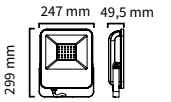

PROYECTOR EXTERIOR	150W IP65	NEW!	3200K	PRY-416	178,77€
PROYECTOR EXTERIOR	150W IP65		4200K	PRY-128	178,77€

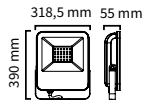

PROYECTOR EXTERIOR	200W IP65	NEW!	3200K	PRY-417	243,09€
PROYECTOR EXTERIOR	200W IP65		4200K	PRY-129	243,09€

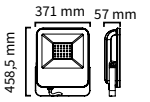

GRAN EFICIENCIA
LUMÍNICA

GRAN
LUMINOSIDAD

High Efficiency
185LM/W



Proyector exterior
ALTA LUMINOSIDAD

NEW!



ALTA
LUMINOSIDAD

185
Lm/w

High Efficiency
185Lm/w

LED CHIP
ALTA CALIDAD



PROYECTOR EXTERIOR LED	NEW!	50W IP65	K°	Ref	PVPR
			4200K	PRY-440	46,98€

50 W 9300 Lm 230 V 4 120° IP 65 >0,9 FP

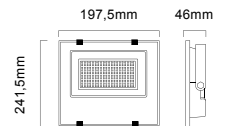

PROYECTOR EXTERIOR LED	NEW!	100W IP65	K°	Ref	PVPR
			4200K	PRY-441	86,04€
			5000K	PRY-442	86,04€

100 W 18500 Lm 230 V 4 120° IP 65 >0,9 FP

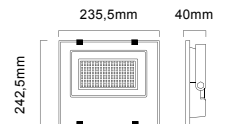

PROYECTOR EXTERIOR LED	NEW!	150W IP65	K°	Ref	PVPR
			5000K	PRY-443	132,06€

150 W 27750 Lm 230 V 4 120° IP 65 >0,9 FP

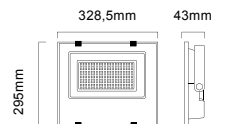

PROYECTOR EXTERIOR LED	NEW!	200W IP65	K°	Ref	PVPR
			5000K	PRY-444	173,70€

200 W 37000 Lm 230 V 4 120° IP 65 >0,9 FP

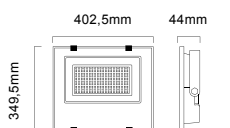

* Según la nueva normativa ERP ha habido un cambio en la medición de Lúmenes y vatios, pero sigue emitiendo la misma cantidad de luz. A medida que vayan entrando los nuevos modelos con ERP se irá actualizando en catálogo y cajas de color. Puede haber variación respecto a la caja del producto (comprobar en ficha técnica), todos los datos en catálogo están correctos salvo error tipográfico.



Proyector exterior MINI

ROTACIÓN 140°



		K°	Ref	PVPR
PROYECTOR EXTERIOR MINI	10W IP67	3200K	PRY-133	15,72€
PROYECTOR EXTERIOR MINI	10W IP67	4200K	PRY-134	15,72€
PROYECTOR EXTERIOR MINI	10W IP67	5000K	PRY-117	15,72€

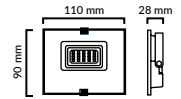

PROYECTOR EXTERIOR MINI	20W IP67	3200K	PRY-135	22,02€
PROYECTOR EXTERIOR MINI	20W IP67	4200K	PRY-136	22,02€
PROYECTOR EXTERIOR MINI	20W IP67	5000K	PRY-118	22,02€

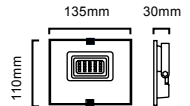

PROYECTOR EXTERIOR MINI	30W IP67	3200K	PRY-400	29,64€
PROYECTOR EXTERIOR MINI	30W IP67	4200K	PRY-399	29,64€
PROYECTOR EXTERIOR MINI	30W IP67	5000K	PRY-119	29,64€

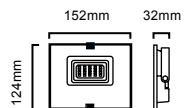

PROYECTOR EXTERIOR MINI	50W IP67	3200K	PRY-402	42,09€
PROYECTOR EXTERIOR MINI	50W IP67	4200K	PRY-401	42,09€
PROYECTOR EXTERIOR MINI	50W IP67	5000K	PRY-120	42,09€

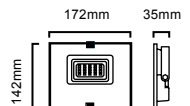

PROYECTOR EXTERIOR MINI	100W IP67	5000K	PRY-121	68,52€
-------------------------	-----------	-------	---------	--------

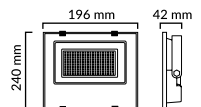

NEW!



PROYECTOR EXTERIOR MINI	150W IP67	5000K	PRY-405	105,75€
-------------------------	-----------	-------	---------	---------

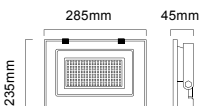

NEW!



PROYECTOR EXTERIOR MINI	200W IP67	5000K	PRY-406	132,39€
-------------------------	-----------	-------	---------	---------

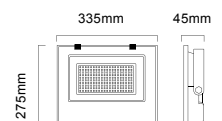

PROYECTOR EXTERIOR MINI CON SENSOR DE MOVIMIENTO

ROTACIÓN 140°



PROYECTOR EXTERIOR MINI	50W IP65	3200K	PRY-404	57,93€
PROYECTOR EXTERIOR MINI	50W IP65	4200K	PRY-403	57,93€
PROYECTOR EXTERIOR MINI	50W IP65	5000K	PRY-130	57,93€

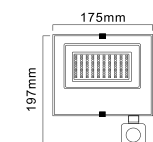

PROYECTOR EXTERIOR MINI	100W IP65	5000K	PRY-131	84,33€
-------------------------	-----------	-------	---------	--------

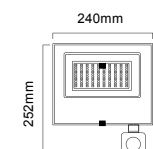



PROYECTOR EXTERIOR ULTRASLIM



ROTACIÓN
270°

		K°	Ref	PVPR
PROYECTOR EXTERIOR	10W IP67	4200K	PRY-074	17,91€

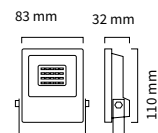

PROYECTOR EXTERIOR	50W IP67	5000K	PRY-084	65,01€
--------------------	----------	-------	---------	--------

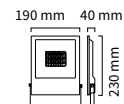

PROYECTOR EXTERIOR	150W IP67	5000K	PRY-066	119,85€
--------------------	-----------	-------	---------	---------

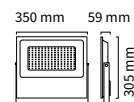

PROYECTOR EXTERIOR	200W IP67	3200K	PRY-067	321,36€
--------------------	-----------	-------	---------	---------

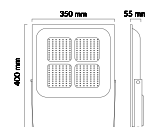

PROYECTOR EXTERIOR BLANCO



ROTACIÓN
270°

		K°	Ref	PVPR
PROYECTOR EXTERIOR BLANCO	10W IP66	3200K	PRY-085	17,91€
PROYECTOR EXTERIOR BLANCO	10W IP66	4200K	PRY-086	17,91€
PROYECTOR EXTERIOR BLANCO	10W IP66	5000K	PRY-087	17,91€

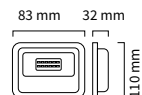

PROYECTOR EXTERIOR BLANCO	20W IP66	3200K	PRY-088	28,71€
PROYECTOR EXTERIOR BLANCO	20W IP66	4200K	PRY-089	28,71€
PROYECTOR EXTERIOR BLANCO	20W IP66	5000K	PRY-070	28,71€

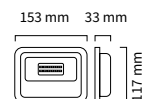

PROYECTOR EXTERIOR BLANCO	30W IP66	3200K	PRY-090	43,17€
PROYECTOR EXTERIOR BLANCO	30W IP66	4200K	PRY-091	43,17€
PROYECTOR EXTERIOR BLANCO	30W IP66	5000K	PRY-071	43,17€



PROYECTOR EXTERIOR BLANCO	50W IP66	3200K	PRY-092	64,83€
PROYECTOR EXTERIOR BLANCO	50W IP66	4200K	PRY-093	64,83€
PROYECTOR EXTERIOR BLANCO	50W IP66	5000K	PRY-072	64,83€



* Según la nueva normativa ERP ha habido un cambio en la medición de Lúmenes y vatios, pero sigue emitiendo la misma cantidad de luz.

A medida que vayan entrando los nuevos modelos con ERP se irá actualizando en catálogo y cajas de color.

Puede haber variación respecto a la caja del producto (comprobar en ficha técnica), todos los datos en catálogo están correctos salvo error tipográfico.



SERIE CLASSIC

Eficiencia
110Lm/w



		K°	Ref	PVPR
PROYECTOR EXTERIOR	20W IP66	5000K	● PRY-148	28,02€

20 W
2200 Lm
230 V
20
120°
IP 66
>0,9 FP
↓



PROYECTOR EXTERIOR	30W IP66	5000K	● PRY-149	34,74€
--------------------	-----------------	-------	-----------	--------

30 W
3300 Lm
230 V
10
120°
IP 66
>0,9 FP
↓



PROYECTOR EXTERIOR	50W IP66	5000K	● PRY-150	47,70€
--------------------	-----------------	-------	-----------	--------

50 W
5500 Lm
230 V
10
120°
IP 66
>0,9 FP
↓



PROYECTOR EXTERIOR	100W IP66	5000K	● PRY-151	84,30€
--------------------	------------------	-------	-----------	--------

100 W
11.000 Lm
230 V
5
120°
IP 66
>0,9 FP
↓



Proyector exterior RGB

PROYECTOR EXTERIOR RGB

MODO DE CONTROL CONTROLADOR INFRARROJO



ROTACIÓN 270°

INCLUYE MANDO / CON MEMORIA / ROTACIÓN 270°

K° Ref PVPR

PROYECTOR EXTERIOR RGB **50W 4000Lm IP66** RGB PRY-100 103,38€



PROYECTORES SINCRONIZADOS

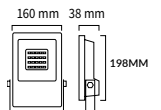

ROTACIÓN 360°

INCLUYE MANDO / CON MEMORIA / ROTACIÓN 360°

PROYECTOR EXTERIOR **20W - 800Lm - IP65** 20 RGB 3CCT PRY-113 35,40€

PROYECTOR EXTERIOR **30W - 1200Lm - IP65** 20 RGB 3CCT PRY-114 49,14€

PROYECTOR EXTERIOR **50W - 2000Lm - IP65** 10 RGB 3CCT PRY-115 57,06€

PROYECTOR EXTERIOR **100W - 4000Lm - IP65** 10 RGB 3CCT PRY-116 92,43€

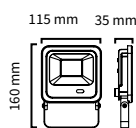

PRY-113

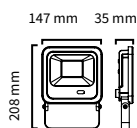

PRY-114

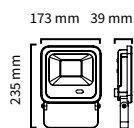

PRY-115

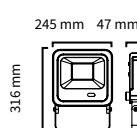

PRY-116

* Según la nueva normativa ERP ha habido un cambio en la medición de Lúmenes y vatios, pero sigue emitiendo la misma cantidad de luz. A medida que vayan entrando los nuevos modelos con ERP se irá actualizando en catálogo y cajas de color. Puede haber variación respecto a la caja del producto (comprobar en ficha técnica), todos los datos en catálogo están correctos salvo error tipográfico.

ILUMINA TU EXTERIOR

Proyector exterior domótico

MODO DE CONTROL

CONTROLADOR RF 2.4Ghz y WiFi



CONTROL REMOTO + INCLUIDO

			K°	Ref	PVPR
PROYECTOR EXTERIOR RGB + 3CCT TUYA	30W IP65			PRY-146	104,04€
30W	230V	1	120°	IP65	>0,9 FP
				WiFi	RGB 3CCT
					tuya
PROYECTOR EXTERIOR RGB + 3CCT TUYA	50W IP65			PRY-147	113,82€
50W	230V	1	120°	IP65	>0,9 FP
				WiFi	RGB 3CCT
					tuya

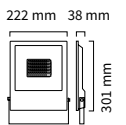
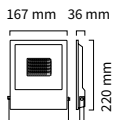

2 MODOS DE CONTROL: WIFI + CONTROLADOR REMOTO - INCLUYE MANDO - CON MEMORIA
 Para el funcionamiento del mando a distancia es necesario vincular primero el proyector a su conexión wifi.



CONTROL REMOTO + INCLUIDO

PROYECTOR EXTERIOR WIFI	10W - 750Lm - IP65	RGB 3CCT	PRY-104	62,73€
PROYECTOR EXTERIOR WIFI	20W - 1600Lm - IP65	RGB 3CCT	PRY-105	66,18€

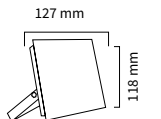

Accesorios

SOPORTE PICA 17 CM PARA PROYECTOR WIFI

Ref PVPR



PICA 17 CM	PARA PROYECTOR WIFI PRY-104	10w	ACLED-122	4,95€
PICA 17 CM	PARA PROYECTOR WIFI PRY-116	100w	ACLED-125	14,94€



PICA JARDIN 16 CM	UNIVERSAL - 2 UNIDADES		ACLED-217	2,34€
-------------------	------------------------	--	-----------	-------

Sensor de movimiento HF 5.8GHz para proyector 100w



Radio 5-10mts. - 25-2000 LUX - 5 Seg.-20 Min.

ACLED-088 24,54€

Sensor de movimiento Infrarrojo para proyector



Radio 5-10mts. - 3-2000 LUX - 10 Seg.-7 Min.

ACLED-087 14,10€

Soporte Kit Sensor



Compatible con los proyectores OSRAM : 20w, 30w, 50w y 100w de Atmos

Incluye conector, lira y tornillería

ACLED-098 Para proyector 20W	ACLED-099 Para proyector 30W	ACLED-100 Para proyector 50W	ACLED-101 Para proyector 100W
20,10€	20,10€	25,23€	25,23€

Protector sobretensión transitorio para LED SPD-20-240P



Protege sobretensiones de hasta 20kA



AXLED - 011 54€

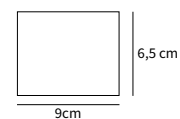

Conector de cable Estanco



Para proyector "I"

ACLED -044 8,67€

Conector de cable Estanco



Para proyector "T"

ACLED - 079 15,90€

Soporte brazo para proyector Exterior



Máx. 100W - 80cm

ACLED-025 56,70€



Serie **Gama Solar**



Ángulo ajustable
90°

¿Te imaginas no depender nunca más de la red eléctrica?

Con la iluminación solar, eso es posible. Es como decirle adiós a las facturas interminables y a los cortes de luz.

Instalas las luces donde quieras, sin preocuparte por cables, permisos complicados o tarifas que suben cada año. Solo necesitas el sol, y el resto funciona solo.

Puedes ahorrar hasta un 80% en costes de energía.

Es simple: menos líos, más ahorro, y una libertad que no tiene precio.

Piensa en todo lo que podrías hacer con ese dinero que ya no gastas en luz.

La iluminación solar es ese cambio que te da tranquilidad y te pone por delante.

¿Te animas a probar?



Conoce la nueva gama en
ILUMINACIÓN SOLAR

Serie Farolas Solar

NEW!



Battery
Li-ion
LITHIUM
CLASE A

GRAN AUTONOMÍA
3.2V 1500mAh

SERIE ALUMINIO

		K°	Ref	PVPR
FAROLA LED SOLAR 63MM DIAM C/MANDO	1800Lm LED IP65	3200K	FRL-056	185,40€
FAROLA LED SOLAR 63MM DIAM C/MANDO	1800Lm LED IP65	4200K	FRL-048	185,40€
FAROLA LED SOLAR 63MM DIAM C/MANDO	1800Lm LED IP65	5000K	FRL-049	185,40€

1800 Lm 1 IP 65 150°

SENSOR PIR MOVIMIENTO

Altura de instalación recomendada: 4m máx
Rango detección: 3m máx

SENSOR CREPUSCULAR

Disponible control remoto

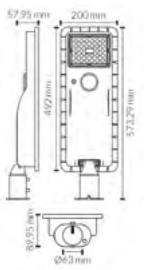

Battery
Li-ion
LITHIUM
CLASE A

GRAN AUTONOMÍA
3.2V 2000mAh

SERIE ALUMINIO

		K°	Ref	PVPR
FAROLA LED SOLAR 63MM DIAM C/MANDO	2600Lm LED IP65	3200K	FRL-057	224,55€
FAROLA LED SOLAR 63MM DIAM C/MANDO	2600Lm LED IP65	4200K	FRL-050	224,55€
FAROLA LED SOLAR 63MM DIAM C/MANDO	2600Lm LED IP65	5000K	FRL-051	224,55€

2600 Lm 1 IP 65 150°

SENSOR PIR MOVIMIENTO

Altura de instalación recomendada: 4m máx

SENSOR CREPUSCULAR

Disponible control remoto

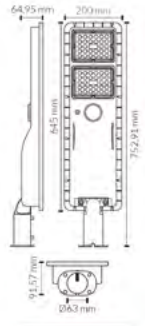

Battery
Li-ion
LITHIUM
CLASE A

GRAN AUTONOMÍA
3.2V 3000mAh

SERIE ALUMINIO

		K°	Ref	PVPR
FAROLA LED SOLAR 63MM DIAM C/MANDO	3400Lm LED IP65	3200K	FRL-058	289,08€
FAROLA LED SOLAR 63MM DIAM C/MANDO	3400Lm LED IP65	4200K	FRL-052	289,08€
FAROLA LED SOLAR 63MM DIAM C/MANDO	3400Lm LED IP65	5000K	FRL-053	289,08€

3400 Lm 1 IP 65 150°

SENSOR PIR MOVIMIENTO

Altura de instalación recomendada: 4m máx

SENSOR CREPUSCULAR

Disponible control remoto

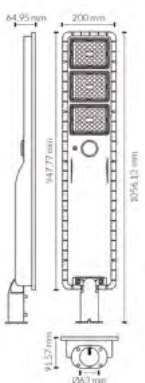

Ø 60mm

		Ref	PVPR
SOPORTE PARA FAROLA SOLAR FRL-048/058	GRIS	ACLED-493	12,30€



CARGA SOLAR



CONTROL INTELIGENTE DE LUZ



RESISTENTE AL AGUA IP65



SENSOR PIR DE MOVIMIENTO



NEW!



GRAN AUTONOMÍA 3.2V 1000mAh

FAROLA LED SOLAR 50MM DIAM C/MANDO

1100Lm LED IP65

K Ref PVPR 5000K FRL-046 154,71€

1100 Lm

1

IP 65

360°

SENSOR PIR MOVIMIENTO

Disponible control remoto

SENSOR CREPUSCULAR



Altura de instalación recomendada: 4m máx

Rango detección: 4m máx



GRAN AUTONOMÍA 3.2V 1800mAh

FAROLA LED SOLAR 50MM DIAM C/MANDO

2100Lm LED IP65

K Ref PVPR 5000K FRL-047 225,60€

2100 Lm

1

IP 65

360°

SENSOR PIR MOVIMIENTO

Disponible control remoto

SENSOR CREPUSCULAR

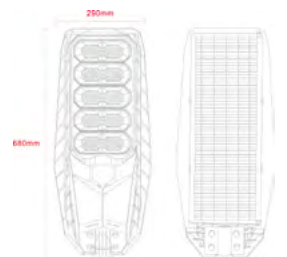

Ø BASE 50mm

SOPORTE PARA FAROLA SOLAR FRL-046/047

NEGRO

Ref PVPR ACLED-492 15,54€

* Según la nueva normativa ERP ha habido un cambio en la medición de Lúmenes y vatios, pero sigue emitiendo la misma cantidad de luz. A medida que vayan entrando los nuevos modelos con ERP se irá actualizando en catálogo y cajas de color. Puede haber variación respecto la caja del producto (comprobar en ficha técnica), todos los datos en catálogo estan correctos salvo error tipográfico.



MODO DE CONTROL
CONTROLADOR RF 2.4Ghz



INCLUYE MANDO

GRAN AUTONOMÍA
3.2V 1800mAh

* ØBase 50mm Sensor de movimiento y crepuscular

FAROLA LED	1080Lm	Bateria LifeP04 18Ah/3.2V	K°	Ref	PVPR
			4200K	FRL-018	154,71€

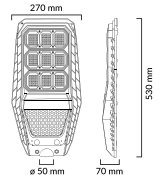

GRAN AUTONOMÍA
3.2V 3000mAh

* ØBase 50mm Sensor de movimiento y crepuscular

FAROLA LED	2130Lm	Bateria LifeP04 30Ah/3.2V	4200K	FRL-020	225,60€
FAROLA LED	2130Lm	Bateria LifeP04 30Ah/3.2V	5000K	FRL-021	225,60€

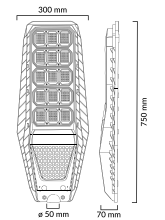

* ØBase 50mm

FAROLA LED	2130Lm	Soporte para farola FRL-018 a FRL-021	NEGRO	ACLED-166	16,86€
------------	--------	---------------------------------------	-------	-----------	--------

FAROLA SOLAR LED - PANEL SOLAR INTEGRADO

 2630 LED Chip

Battery
 Li-ion
 LITHIUM

 SENSOR PIR
 DE MOVIMIENTO

 SENSOR
 CREPUSCULAR

AUTONOMÍA
 3.2V 1000mAh

MODO DE CONTROL CONTROLADOR RF 2.4Ghz

 INCLUYE
 MANDO

 Ø base 48mm - COMPATIBLE CON ACLED-102-103-104 -
 SENSOR DE MOVIMIENTO Y CREPUSCULAR

				Kº	Ref	PVPR
FAROLA SOLAR LED	950Lm	Batería LifePO4 Litio 10Ah	4200K		FRL-012	156,87€
FAROLA SOLAR LED	950Lm	Batería LifePO4 Litio 10Ah	5000K		FRL-013	156,87€

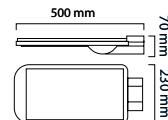
AUTONOMÍA
 3.2V 1500mAh

 INCLUYE
 MANDO

Ø base 48mm - COMPATIBLE CON ACLED-102-103-104 - SENSOR DE MOVIMIENTO Y CREPUSCULAR

FAROLA SOLAR LED	1900Lm	Batería LifePO4 Litio 15Ah	4200K		FRL-010	170,31€
FAROLA SOLAR LED	1900Lm	Batería LifePO4 Litio 15Ah	5000K		FRL-011	170,31€

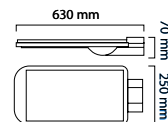

* ØBase 5cm - 50cm

Soporte para farola FRL-010 a FRL-013	GRIS	ACLED-171	16,86€
---------------------------------------	------	-----------	--------

Serie Proyector solar con panel externo

PROYECTOR SOLAR **CON PANEL EXTERNO**



MODO DE CONTROL
CONTROLADOR RF 2.4Ghz



RADAR
SENSOR

GRAN
AUTONOMÍA
3.2V 2000mAh

PROYECTOR SOLAR CON MANDO **BATERÍA LifeP04 BYD 3.2V 20Ah** 5000K **PRY-123 113,85€**

545
Lm
PRY-122

2010
Lm
PRY-123



DESCARGAR
INSTRUCCIONES

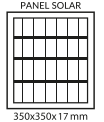
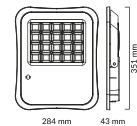

NOTA IMPORTANTE PARA LA PUESTA EN MARCHA DEL PANEL

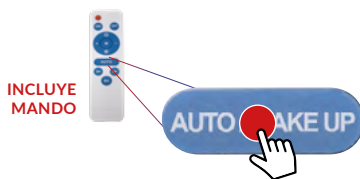

Para poder usar el proyector, hay que desbloquear el mando pulsando en medio, el botón "AUTO/WAKE UP".

El proyector esta bloqueado debido a un sistema de protección para que la batería no se agote.

NEW!



BATERÍA
3.2V 1200mAh

MODO DE CONTROL
CONTROLADOR RF 2.4Ghz

PROYECTOR SOLAR CON MANDO **BATERÍA LifeP04 BYD 3.2V 12Ah** 5000K **PRY-160 77,85€**

1200
Lm

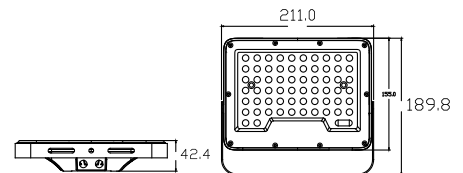



PROYECTOR SOLAR 3CCT CON PANEL EXTERNO

MODO DE CONTROL
CONTROLADOR RF 2.4Ghz



3 en 1 TRES TIPOS DE LUZ
EN LA MISMA LUMINARIA



Switch
3CCT



BATERÍA
3.2V 2500mAh

ALUMINIO - SENSOR CREPUSCULAR Panel solar (6V 20W) + proyector

PROYECTOR SOLAR CON MANDO BATERÍA LifeP04 BYD 3.2V 25Ah 3CCT PRY-132 107,85€

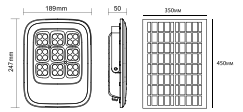

RADAR
SENSOR INCLUYE
MANDO

BATERÍA
3.2V 4000mAh

ALUMINIO - SENSOR CREPUSCULAR Panel solar (6V 40W) + proyector

PROYECTOR SOLAR CON MANDO BATERÍA LifeP04 BYD 3.2V 40Ah 3CCT PRY-137 141,90€

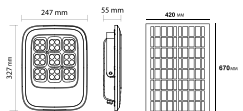

* Según la nueva normativa ERP ha habido un cambio en la medición de Lúmenes y vatios, pero sigue emitiendo la misma cantidad de luz. A medida que vayan entrando los nuevos modelos con ERP se irá actualizando en catálogo y cajas de color. Puede haber variación respecto la caja del producto (comprobar en ficha técnica), todos los datos en catálogo están correctos salvo error tipográfico.



2 MODOS DE CONTROL

CONTROLADOR
RF 2.4Ghz

WIFI



INCLUYE
MANDO

Battery
Li-ion
LITHIUM

Proyector solar con cámara domótico

2 MODOS DE CONTROL

WIFI + CONTROLADOR RF 2.4Ghz

COMPATIBLE
CON APP **tuya**

WiFi + RF

**GRAN
AUTONOMÍA**
3000mAh

SENSOR DE MOVIMIENTO Y CREPUSCULAR

PROYECTOR SOLAR CON CÁMARA 3000Lm Bateria Li-On 30Ah

Kº	Ref	PVPR
6000K	PRY-140	296,25€

Campo de detección: 5 - 8 metros Ángulo de detección: 200º



SENSOR PIR
DE MOVIMIENTO

SENSOR
CREPUSCULAR

1	120º	3000 Lm	IP 66	WiFi
WiFi	Clock	Sun	Battery	RF

- Sensor de movimiento
- Sensor de luz
- Cámara HD
- Automaticamente se encienden las luces cuando detecta movimiento.



Proyector solar de trabajo

LUZ EMERGENCIA



3 MODOS DE LUZ / LUZ EMERGENCIA

PROYECTOR SOLAR AMARILLO 3.7V 5000mAh Li-ion 6000K PRY-143 74,07€

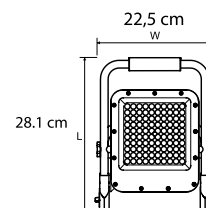

3 MODOS DE LUZ / LUZ EMERGENCIA

PROYECTOR SOLAR AMARILLO 3.7V 10.000mAh Li-ion 6000K PRY-144 106,20€

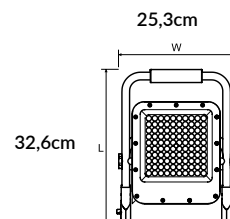

3 MODOS DE LUZ / LUZ EMERGENCIA

PROYECTOR SOLAR AMARILLO 3.7V 15.000mAh Li-ion 6000K PRY-145 143,67€

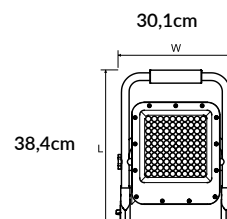

* Según la nueva normativa ERP ha habido un cambio en la medición de Lúmenes y vatios, pero sigue emitiendo la misma cantidad de luz. A medida que vayan entrando los nuevos modelos con ERP se irá actualizando en catálogo y cajas de color. Puede haber variación respecto la caja del producto (comprobar en ficha técnica), todos los datos en catálogo están correctos salvo error tipográfico.



NEW PRICE!!

CAMPANA SOLAR CON PANEL EXTERNO



MODO DE CONTROL
CONTROLADOR RF 2.4Ghz

RADAR
SENSOR

	K°	Ref	PVPR
CAMPANA SOLAR 1800Lm 3.2V 25Ah IP65	5000K	CMP-026	164,70 €



INCLUYE MANDO

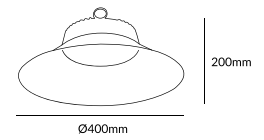

1800 Lm
5
120°
IP 65
↓

FAROLA SOLAR DE JARDIN

Nuestras farolas LED para exteriores son ideales para iluminación exterior comercial, industrial o residencial.



MODO DE CONTROL
CONTROLADOR RF 2.4Ghz

* MASTIL EN GRIS NO INCLUIDO



Fuente de luz de altos lúmenes



Configuración de temporizador



Panel solar



IP65 Impermeable



Batería de alta calidad



Ahorro de energía

NEW!



Battery
Li-ion
LITHIUM



INCLUYE MANDO



BATERÍA
3.2V 4000mAh

COMPATIBLE CON
MASTIL FRL-035



K°

Ref

PVPR

FAROLA SOLAR 3600Lm 3.2V 40Ah IP65 3CCT FRL-061 292,38 €

3600 Lm

1

120°

IP 65



3 en 1 TRES TIPOS DE LUZ
EN LA MISMA LUMINARIA

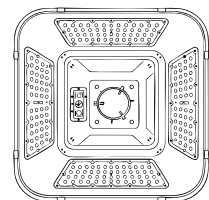

57cm

57cm

8 cm

* Según la nueva normativa ERP ha habido un cambio en la medición de Lúmenes y vatios, pero sigue emitiendo la misma cantidad de luz.

A medida que vayan entrando los nuevos modelos con ERP se irá actualizando en catálogo y cajas de color.

Puede haber variación respecto la caja del producto (comprobar en ficha técnica), todos los datos en catálogo estan correctos salvo error tipográfico.

Serie Farolas UFO Solar

MODO DE CONTROL CONTROLADOR RF 2.4Ghz



INCLUYE MANDO

COMPATIBLE CON MASTIL FRL-035



GRAN AUTONOMÍA
3.2V 2000mAh

Ø base 80mm - SENSOR DE MOVIMIENTO Y CREPUSCULAR

FAROLA SOLAR LED UFO 900Lm Batería LifePO4 Litio 3.2V / 20Ah 3200K FRL-014 131,46€

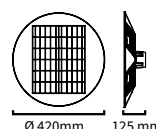

INCLUYE MANDO

NUEVO DISEÑO
COMPATIBLE CON MASTIL FRL-035



GRAN AUTONOMÍA
3.2V 2000mAh

Ø base 75mm - SENSOR DE MOVIMIENTO Y CREPUSCULAR

FAROLA SOLAR LED UFO 900Lm Batería LifePO4 Litio 3.2V/20Ah 3200K FRL-031 149,70€

FAROLA SOLAR LED UFO 900Lm Batería LifePO4 Litio 3.2V/20Ah 5000K FRL-032 149,70€

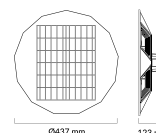

INCLUYE MANDO

NUEVO DISEÑO
COMPATIBLE CON MASTIL FRL-035



GRAN AUTONOMÍA
3.2V 2500mAh

Ø base 75mm - SENSOR DE MOVIMIENTO Y CREPUSCULAR

FAROLA SOLAR LED UFO 1400Lm Batería LifePO4 Litio 3.2V/25Ah 3200K FRL-033 201,30€

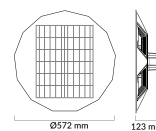

NUEVO DISEÑO | **NUEVA BATERÍA**



NEW!



Disponible control remoto

INSTALACIÓN MÁXIMA 3 METROS
COMPATIBLE CON MASTIL FRL-035



GRAN AUTONOMÍA
3.2V 2000mAh

Ø BASE 77mm - SENSOR DE MOVIMIENTO Y CREPUSCULAR

K°

Ref

PVPR

FAROLA LED SOLAR 50MM DIAM C/MANDO	1800Lm LED IP65	3200K	FRL-054	215,70€
FAROLA LED SOLAR 50MM DIAM C/MANDO	1800Lm LED IP65	5000K	FRL-055	215,70€



TEMPORIZADOR



CONTROL DE LUZ INTELIGENTE



MANDO A DISTANCIA



SENSOR DE MOVIMIENTO PIR



78mm

550mm

INSTALACIÓN MÁXIMA 3 METROS
COMPATIBLE CON MASTIL FRL-035



GRAN AUTONOMÍA
3.2V 1500mAh

Ø BASE 77mm - SENSOR DE MOVIMIENTO Y CREPUSCULAR

FAROLA LED SOLAR 50MM DIAM C/MANDO	1300Lm LED IP65	5000K	FRL-060	201,30€
------------------------------------	-----------------	-------	---------	---------



TEMPORIZADOR



CONTROL DE LUZ INTELIGENTE



MANDO A DISTANCIA



SENSOR DE MOVIMIENTO PIR

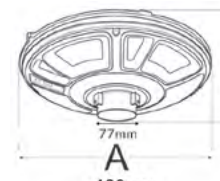

60mm

420mm



NEW!



Disponible control remoto



COMPATIBLE SOLO PARA FAROLAS SOLAR UFO

FAROLA MASTIL 3 METROS PARA FRL NEW UFO CON AGARRE SUELO

FRL-035 336,69€



- * Farola UFO no incluida
- * Disponible solo comprando nuestra Farola Solar UFO.
- * Venta sin montaje.
- * Pintado en color negro.

Diametro final para farola Ø73mm

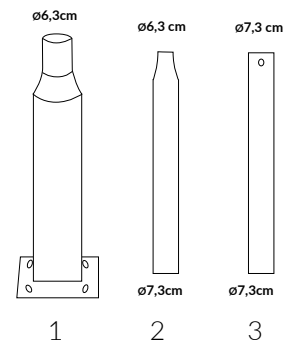

Orden de colocación

Serie Apliques solares



ESPECIAL
**PUERTAS,
FACHADAS Y
LETREROS**



**GRAN
AUTONOMÍA**
3.7V 2000mAh*2

APLIQUE SOLAR PARED

3.7V 2000mAh Li-ion *2Uds

K°

3200K

Ref

APQ-098

PVPR

50,85€

1000
Lm

1

120°

IP
65

SENSOR PIR
DE MOVIMIENTO

3 MODOS DE USO





3 en 1 TRES TIPOS DE LUZ
EN LA MISMA LUMINARIA

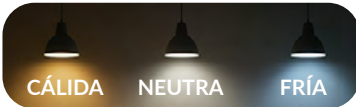

BATERÍA
3.2V 5000mAh

	K°	Ref	PVPR
APLIQUE SOLAR PARED	3CCT	APQ-100	-----

- 700 Lm
- 1
- 90°
- IP 65

2 MODOS DE INSTALACIÓN

- PARED
- COLUMNA

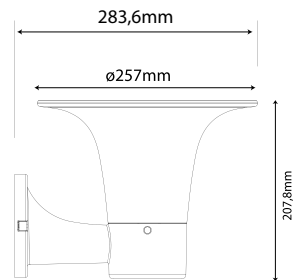

* Según la nueva normativa ERP ha habido un cambio en la medición de Lúmenes y vatios, pero sigue emitiendo la misma cantidad de luz. A medida que vayan entrando los nuevos modelos con ERP se irá actualizando en catálogo y cajas de color. Puede haber variación respecto la caja del producto (comprobar en ficha técnica), todos los datos en catálogo están correctos salvo error tipográfico.



BATERÍA MEJORADA DE LARGA DURACIÓN

K° Ref

APLIQUE SOLAR PARED 3.7V 2500mAh Li-ion

3CCT PRY-162



NEW!



GRAN AUTONOMÍA
3.7V 2500mAh



3 MODOS DE USO

3 en 1 TRES TIPOS DE LUZ
EN LA MISMA LUMINARIA

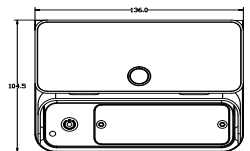
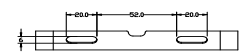
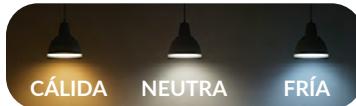

BATERÍA MEJORADA DE LARGA DURACIÓN

K° Ref

APLIQUE SOLAR PARED 3.7V 2500mAh * 2 Li-ion

3CCT PRY-163



NEW!



GRAN AUTONOMÍA
3.7V 2500mAh*2



3 MODOS DE USO

3 en 1 TRES TIPOS DE LUZ
EN LA MISMA LUMINARIA

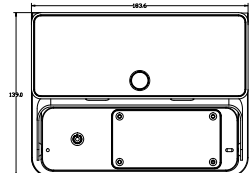
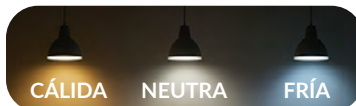

RADAR SENSOR

K° Ref PVPR

APLIQUE SOLAR PARED CON RADAR SENSOR 3.7V 2600mAh Li-ion

5000K APQ-058 26,85€



GRAN AUTONOMÍA
3.7V 2600mAh



ROTACIÓN 180°



Botón en el lateral



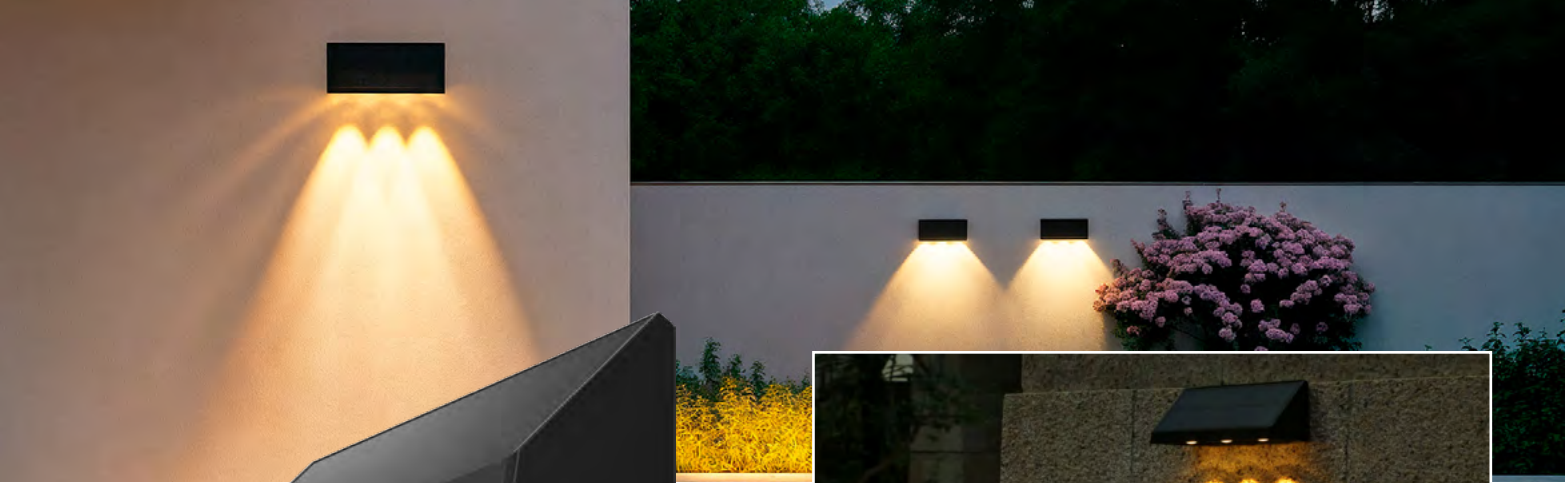

NEW!



GRAN AUTONOMÍA
3.7V 1800mAh

APLIQUE SOLAR PARED 3.7V 1800mAh Li-ion K° 3200K Ref APQ-095 PVPR 22,80€

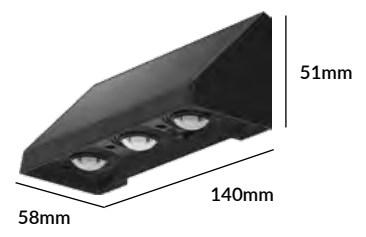

GRAN AUTONOMÍA
3.7V 1200mAh

APLIQUE SOLAR PARED 3.7V 1200mAh Li-ion K° 3CCT Ref APQ-096 PVPR 18€



3 en 1 TRES TIPOS DE LUZ EN LA MISMA LUMINARIA

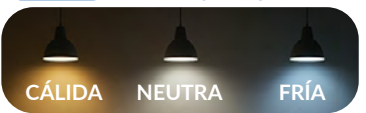

NEW!



* Según la nueva normativa ERP ha habido un cambio en la medición de Lúmenes y vatios, pero sigue emitiendo la misma cantidad de luz. A medida que vayan entrando los nuevos modelos con ERP se irá actualizando en catálogo y cajas de color. Puede haber variación respecto la caja del producto (comprobar en ficha técnica), todos los datos en catálogo están correctos salvo error tipográfico.

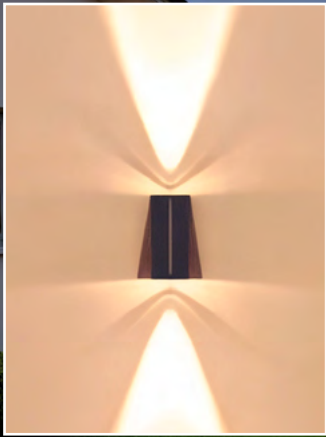

NEW!



APLIQUE SOLAR PARED

3.7V 1800mAh Li-ion

K°

Ref

PVPR

3200K



APQ-091

26,85€

200
Lm



90°

IP
65



75mm



150mm

120mm



GRAN AUTONOMÍA
3.7V 1800mAh

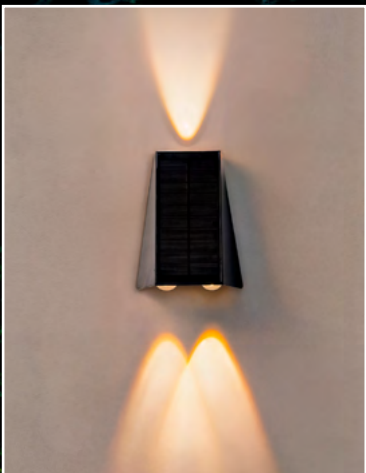

NEW!



APLIQUE SOLAR PARED

3.7V 1800mAh Li-ion

K°

Ref

PVPR

3200K



APQ-092

28,50€

300
Lm



90°

IP
65



75mm



150mm

120mm



GRAN AUTONOMÍA
3.7V 1800mAh

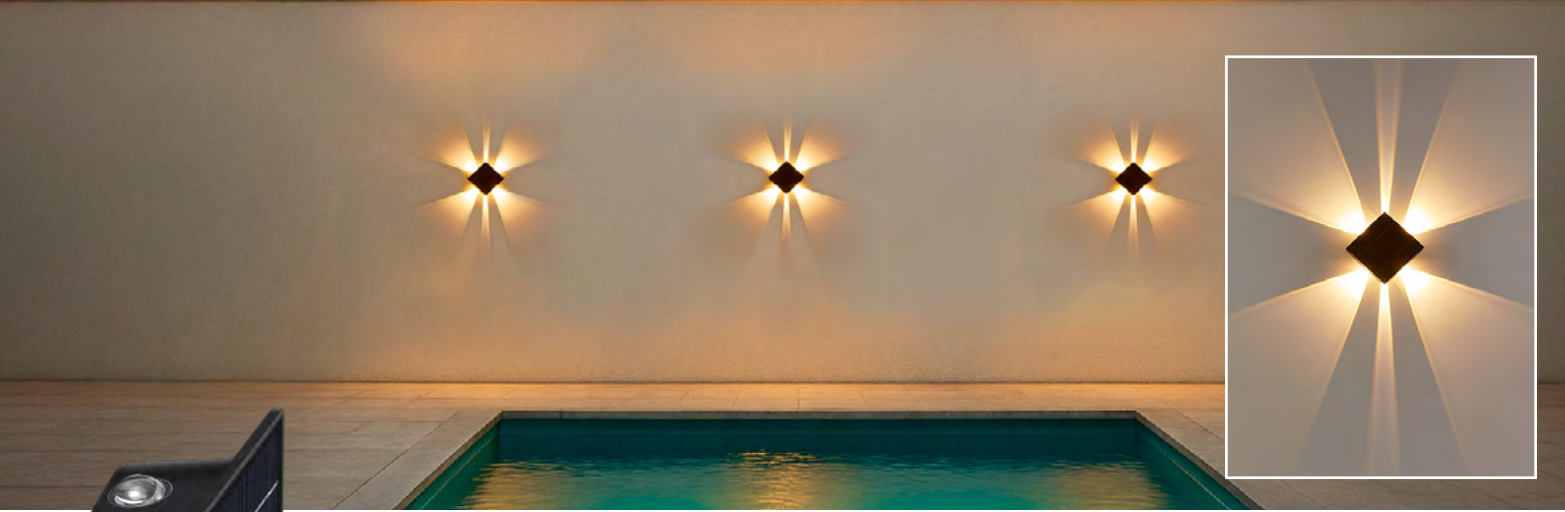

NEW!



APLIQUE SOLAR PARED	3.7V 1800mAh Li-ion	K°	Ref	PVPR
		3200K	APQ-089	28,50€

200 Lm
1
90°
IP 65
↓

Battery
Li-ion
LITHIUM

GRAN AUTONOMÍA
3.7V 1800mAh

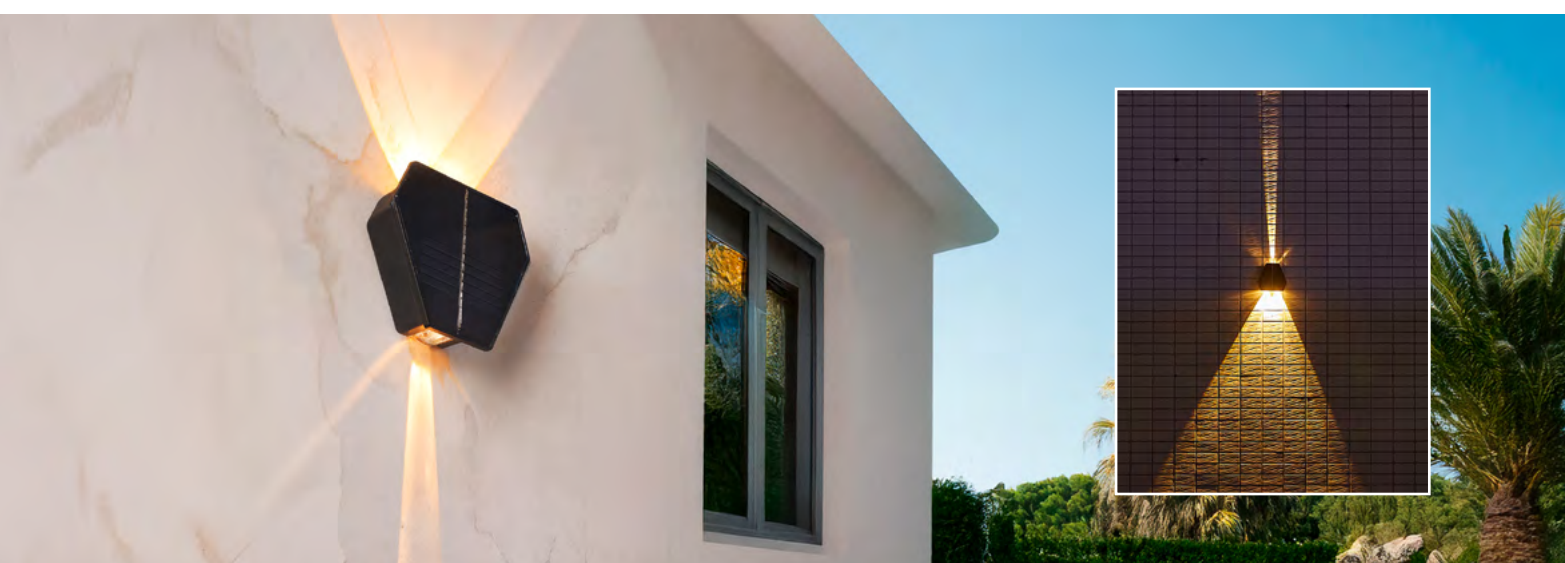
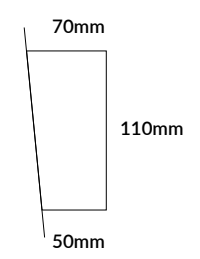
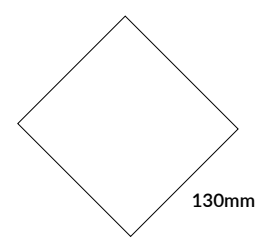

NEW!



APLIQUE SOLAR PARED	3.7V 1800mAh Li-ion	K°	Ref	PVPR
		3200K	APQ-090	23,85€

200 Lm
1
90°
IP 65
↓

Battery
Li-ion
LITHIUM

GRAN AUTONOMÍA
3.7V 1800mAh

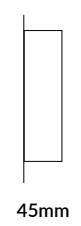
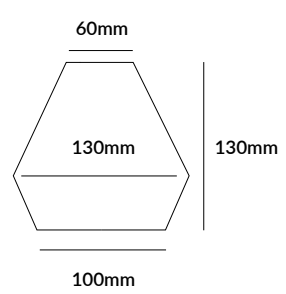

* Según la nueva normativa ERP ha habido un cambio en la medición de Lúmenes y vatios, pero sigue emitiendo la misma cantidad de luz. A medida que vayan entrando los nuevos modelos con ERP se irá actualizando en catálogo y cajas de color. Puede haber variación respecto la caja del producto (comprobar en ficha técnica), todos los datos en catálogo están correctos salvo error tipográfico.

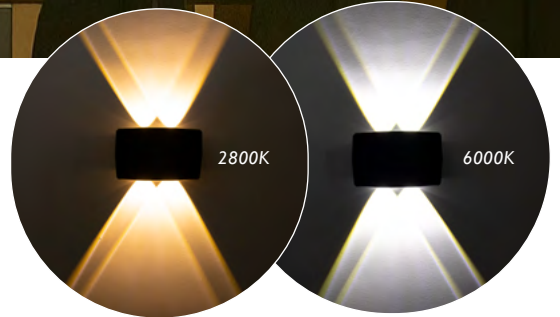
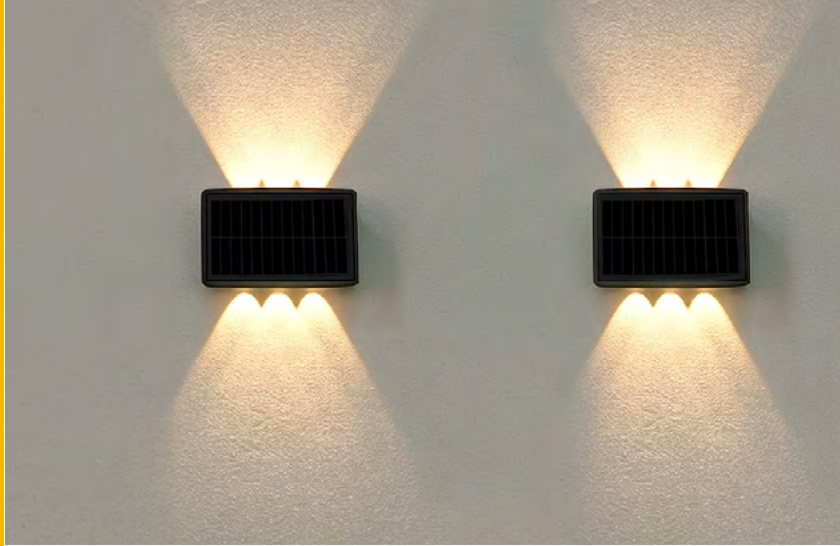

APLIQUE LED SOLAR 4 y 6 LEDS



2 EN 1 DUAL COLOR 4LEDS SMD5050
2 COLORES EN 1

APLIQUE LED SOLAR 18650 3.7V 1800mAh 2800K 6000K APQ-055 26,85€



GRAN AUTONOMÍA
3.7V 1800mAh

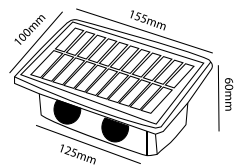

Botón en la parte trasera



2 EN 1 DUAL COLOR 6LEDS SMD5050
2 COLORES EN 1

APLIQUE LED SOLAR 18650 3.7V 2200mAh 2800K 6000K APQ-057 35,85€



GRAN AUTONOMÍA
3.7V 2200mAh

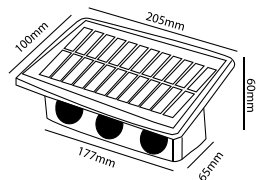

RGB 4LEDS SMD5050

APLIQUE LED SOLAR 18650 3.7V 1800mAh RGB APQ-056 26,85€



GRAN AUTONOMÍA
3.7V 1800mAh

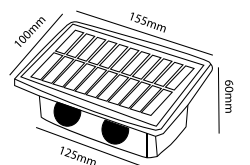

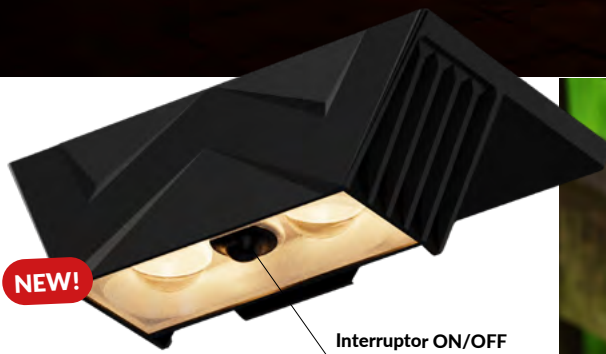

2 Modos de instalación: (Accesorios incluidos)

• Cinta adhesiva 3M

• Anclado con tornillo



Batería
3.2V 500mAh

APLIQUE SOLAR VALLA

3.2V 500mAh Li-ion

K° Ref PVPR

3200K ● APQ-099 19,05€

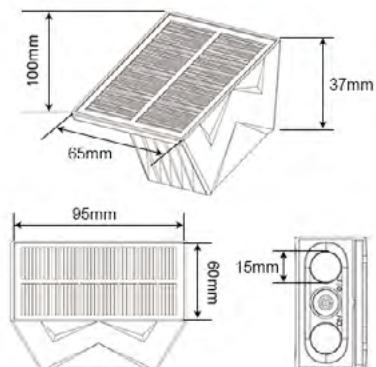

* Según la nueva normativa ERP ha habido un cambio en la medición de Lúmenes y vatios, pero sigue emitiendo la misma cantidad de luz. A medida que vayan entrando los nuevos modelos con ERP se irá actualizando en catálogo y cajas de color. Puede haber variación respecto la caja del producto (comprobar en ficha técnica), todos los datos en catálogo están correctos salvo error tipográfico.



NEW!

APLIQUE SOLAR PARED	3.7V 3600mAh Li-ion	K°	Ref	PVPR
		3200K	APQ-088	43,56€



4 MODOS



1º MODO - 100% LUZ

2º MODO - 30% LUZ

3º MODO - INTENSIDAD DE LUZ AUMENTA Y DISMINUYE DE FORMA AUTOMÁTICA

4º MODO - LUZ PARPADEANTE



GRAN AUTONOMÍA
3.7V 3600mAh



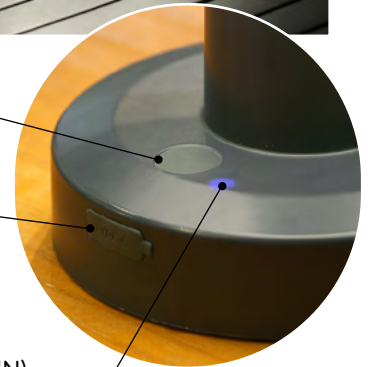
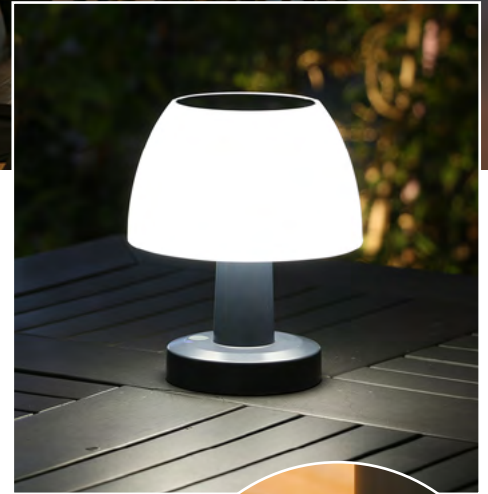

Botón ON/OFF

Carga USB Tipo-C

Led indicador Azul (Modo IN)



4 MODOS DE LUZ

- 1ª 25%
- 2º 50%
- 3º 75%
- 4º 100%

2 MODOS IN/OUT

IN - Modo interior:

Para uso en interiores, utilice un cable tipo C para conectar la alimentación de 5 V para cargar la batería e iluminar la lámpara. El sensor de luz no funciona en este modo: la lámpara no se enciende ni se apaga automáticamente. Para encenderla o apagarla, presione el interruptor ON/OFF. Modo IN, La luz indicadora IN se encenderá luz azul.

EX - Modo exterior:

Para uso en exteriores, el panel solar carga la batería. El sensor de luz funciona: La lámpara se apaga automáticamente durante el día y se enciende automáticamente por la noche. Ofrece una luz que dura desde el anochecer hasta el amanecer.

Botón IN/OUT



18cm

15cm

LÁMPARA DE MESA

3.7V 2200mAh Li-ion

K°
4000K

Ref
LMP-100

PVPR
45,15€



* Según la nueva normativa ERP ha habido un cambio en la medición de Lúmenes y vatios, pero sigue emitiendo la misma cantidad de luz. A medida que vayan entrando los nuevos modelos con ERP se irá actualizando en catálogo y cajas de color. Puede haber variación respecto a la caja del producto (comprobar en ficha técnica), todos los datos en catálogo están correctos salvo error tipográfico.



NEW!



GRAN AUTONOMÍA
3.7V 1500mAh

SERIE PLASTIC

APLIQUE LED SOLAR PARED 2 DIRECCIONES

IP65

3200K

● APQ-071

Ref

PVPR



Ángulo de luz AJUSTABLE

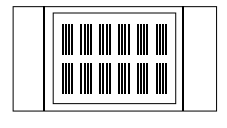

130mm

85mm



GRAN AUTONOMÍA
3.7V 1500mAh

SERIE PLASTIC

APLIQUE LED SOLAR PARED 2 DIRECCIONES

IP65

3200K/5000K

● ● APQ-072

Ref

PVPR

24,54€



Ángulo de luz AJUSTABLE



DUAL COLOR



3200K
5000K

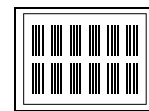

95mm

80mm

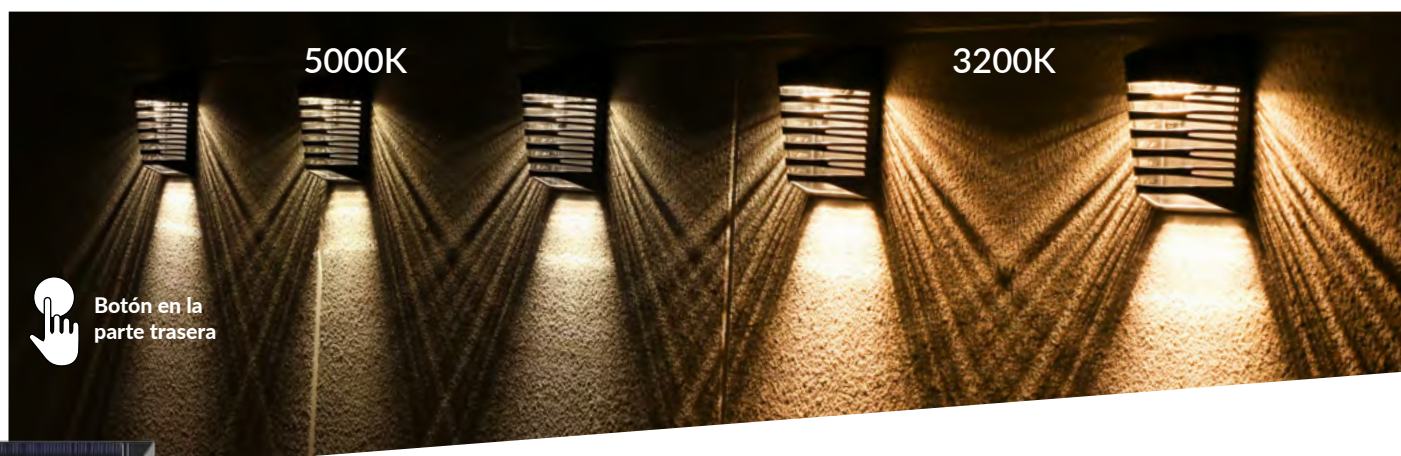

5000K

3200K



Botón en la parte trasera



Batería
3.2V 500mAh

APLIQUE LED SOLAR NEGRO RECTANGULAR *Batería Li-Tio 3.2V 500mAh*

K°

Ref

PVPR

3200K ●

APQ-053

20,58€

APLIQUE LED SOLAR NEGRO RECTANGULAR *Batería Li-Tio 3.2V 500mAh*

5000K ●

APQ-054

20,58€



5.25 CM

12 CM



APLIQUE LED SOLAR CON RADAR SENSOR

DOS COLORES DE
LUZ DISPONIBLES

DISEÑO MODERNO MINIMALISTA

3200K ● 5000K ●

APLIQUE LED SOLAR	IP65	BATERÍA 18650 3.7V 1800mAh	300Lm	3200K	●	APQ-059	29,85€
APLIQUE LED SOLAR	IP65	BATERÍA 18650 3.7V 1800mAh	300Lm	5000K	●	APQ-060	29,85€
APLIQUE LED SOLAR	IP65	BATERÍA 18650 3.7V 2200mAh	400Lm	3200K	●	APQ-061	41,85€
APLIQUE LED SOLAR	IP65	BATERÍA 18650 3.7V 2200mAh	400Lm	5000K	●	APQ-062	41,85€

SENSOR RADAR
DE MOVIMIENTO

**GRAN
AUTONOMÍA**
3.7V 1800mAh
3.7V 2200mAh



NEW!



**GRAN
AUTONOMÍA**
3.7V 1500mAh

SERIE PLASTIC

Ref PVPR

APLIQUE LED SOLAR PARED PIRAMIDE NEGRO IP65 5000K ● APQ-075 11,28€



SENSOR PIR
MOVIMIENTO



**GRAN
AUTONOMÍA**
3.7V 1200mAh

SENSOR DE MOVIMIENTO PIR Y SENSOR CREPUSCULAR

APLIQUE LED SOLAR PARED IP65 BATERÍA ION LITIO 1200mAh 3.7V 3200K ● APQ-003 12,66€



SENSOR PIR DE MOVIMIENTO ● SENSOR CREPUSCULAR

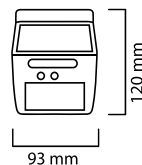

NEW PRICE!!



**GRAN
AUTONOMÍA**
3.7V 2200mAh

SENSOR DE MOVIMIENTO PIR Y SENSOR CREPUSCULAR

APLIQUE LED SOLAR PARED IP65 BATERÍA LIFEPO4 2200mAh 3200K ● APQ-005 16,50€
APLIQUE LED SOLAR PARED IP65 BATERÍA LIFEPO4 2200mAh 5000K ● APQ-006 16,50€



SENSOR PIR DE MOVIMIENTO ● SENSOR CREPUSCULAR

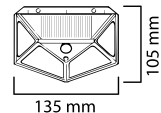

NEW PRICE!!



**GRAN
AUTONOMÍA**
3.7V 2200mAh

SENSOR DE MOVIMIENTO PIR Y SENSOR CREPUSCULAR

APLIQUE LED SOLAR PARED IP65 212LED 2 BATERÍA LIFEPO4 2200mAh 3200K ● APQ-044 23,85€
APLIQUE LED SOLAR PARED IP65 212LED 2 BATERÍA LIFEPO4 2200mAh 5000K ● APQ-045 23,85€



SENSOR PIR DE MOVIMIENTO ● SENSOR CREPUSCULAR

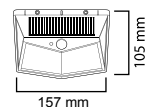

* Según la nueva normativa ERP ha habido un cambio en la medición de Lúmenes y vatios, pero sigue emitiendo la misma cantidad de luz. A medida que vayan entrando los nuevos modelos con ERP se irá actualizando en catálogo y cajas de color. Puede haber variación respecto a la caja del producto (comprobar en ficha técnica), todos los datos en catálogo están correctos salvo error tipográfico.

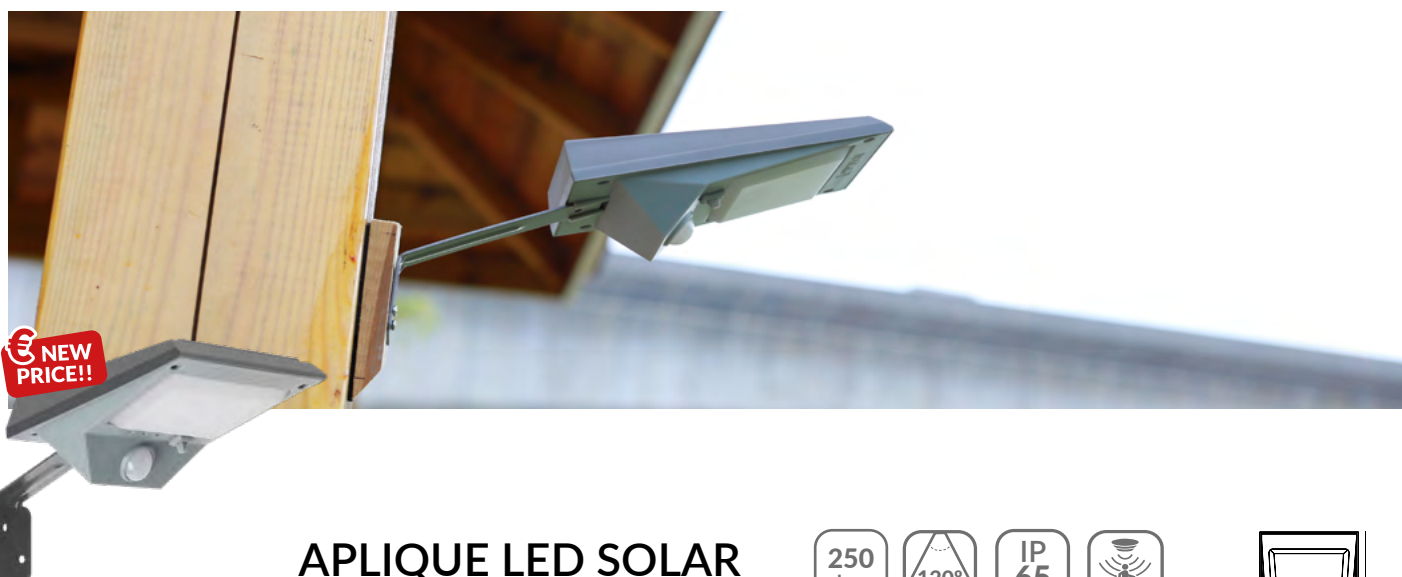

APLIQUE LED SOLAR CON SENSOR DE MOVIMIENTO

250
Lm

120°

IP
65

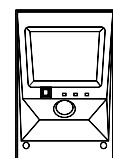

151mm

104mm



Botón
3 MODOS



**GRAN
AUTONOMÍA**
3.2V 2000mAh

SENSOR DE MOVIMIENTO PIR - BRAZO GRIS - 18LEDS SMD2835

APLIQUE LED SOLAR MFA

Batería Li-Tio 3.2V 2000mAh

3200K



APQ-051

38,85€



APLIQUE LED SOLAR MFA

Batería Li-Tio 3.2V 2000mAh

5000K



APQ-052

38,85€



3 MODOS - Luz indicadora de cada modo 1  2  3 

- **Modo1: Sensor de movimiento + modo de luz tenue.** La luz tenue siempre encendida (10Lm) si detecta movimiento se activa a 250Lm
- **Modo2: Modo sensor de movimiento.** Si detecta movimiento se enciende gradualmente hasta 250Lm. Sin detección de movimiento se apaga.
- **Modo3: Modo siempre encendido.** Luz fuerte (50Lm) durante las primeras 5horas, luz tenue (20Lm) durante las siguientes 5 horas.

APLIQUE LED SOLAR

Tres focos 38Leds

GRAN ÁNGULO
DE APERTURA 270°



Botón en la parte trasera

NEW PRICE!!



GRAN AUTONOMÍA
3.2V 2500mAh

APLIQUE LED SOLAR TRES FOCOS *LIFEP04 3.2V 2500mAh Li-ion*

5000K

APQ-050 53,85€

400 Lm

24

120°

IP 65



SENSOR PIR DE MOVIMIENTO

SENSOR CREPUSCULAR

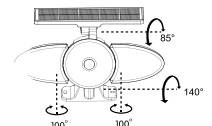
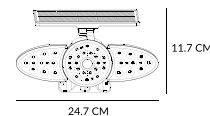

NEW PRICE!!



GRAN AUTONOMÍA
3.7V 6000mAh

SENSOR DE MOVIMIENTO PIR Y SENSOR CREPUSCULAR

APLIQUE LED SOLAR DOBLE FOCO ORIENTABLE *LIFEP04 3.7V 6000mAh Li-ion*

3200K

APQ-013 53,85€

1200 Lm

8

120°

IP 65



SENSOR PIR DE MOVIMIENTO

SENSOR CREPUSCULAR

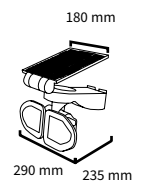

SOLAR VINTAGE



NEW PRICE!!

Battery
Li-ion
LITHIUM

GRAN
AUTONOMÍA
3.7V 1500mAh

LÁMPARA LED SOLAR PARED 5000K

IP65

5000K

APQ-073

PVPR

12,90€



IP 65

150 Lm



SENSOR MOVIMIENTO



SERIE PLASTIC



SOLAR VINTAGE



Battery
Li-ion
LITHIUM

GRAN
AUTONOMÍA
3.7V 1500mAh

Panel solar 5.5V 2w

APLIQUE LED SOLAR

Botón en la parte delantera

3200K

APQ-063

38,85€

200 Lm

120°

IP 65



SENSOR PIR DE MOVIMIENTO

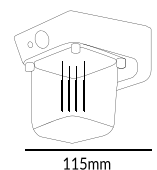



Serie solar jardin

Pared y suelo

DUAL
COLOR



Batería
3.7V 600mAh

Incluido Acc de pared y suelo

SERIE PLASTIC

LED INCLUIDO

APLIQUE SOLAR PARED/SUELO
DUAL COLOR 3200K / 5000K

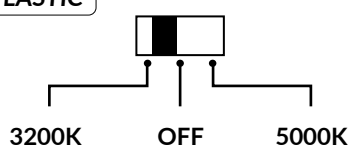

Ref PVPR
APQ-076 26,85€



- IP 65
- Batería 3.7V 600mAh
- Panel solar - 5V 80mA
- Gran autonomía
- Carga solar 6-8Hrs



* Según la nueva normativa ERP ha habido un cambio en la medición de Lúmenes y vatios, pero sigue emitiendo la misma cantidad de luz. A medida que vayan entrando los nuevos modelos con ERP se irá actualizando en catálogo y cajas de color. Puede haber variación respecto la caja del producto (comprobar en ficha técnica), todos los datos en catálogo están correctos salvo error tipográfico.



Battery
Li-ion
LITHIUM



GRAN
AUTONOMÍA
3.7V 2000mAh

Accesorios de pared y suelo incluidos x2

BATERÍA: 3.7V 2000mAh - 2 FORMAS DE COLOCACIÓN (PARED - SUELO)

Ref PVPR

APLIQUE LED SOLAR PARED PIRAMIDE NEGRO IP65 5000K APQ-074 59,40€



SENSOR
MOVIMIENTO

SERIE ALUMINIO



PANEL - VIDRIO



Battery
Li-ion
LITHIUM



GRAN
AUTONOMÍA
3.7V 2600mAh

3 en 1 TRES TIPOS DE LUZ
EN LA MISMA LUMINARIA

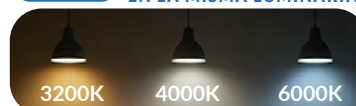

SENSOR CREPUSCULAR - INCLUIDO ACCESORIO DE PARED

FAROLA LED SOLAR JARDIN PARED IP65 BATERÍA LIFEPO4 3.7V 2.6Ah Li-ion 3CCT FRL-022 50,85€



SENSOR
CREPUSCULAR

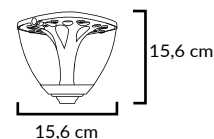

ACLED-167/168/169

NO VIENEN INCLUIDOS
SE VENDEN POR SEPARADO



ACLED - 168
Soporte tubo 20cm
para farola solar
jardin FRL-022

7,56€



ACLED - 169
Soporte pica 23cm
para farola solar
jardin FRL-022

9,42€



ACLED - 167
Soporte base suelo
para farola solar
jardin FRL-022
Ø 6mm

7,56€



Botón en la parte trasera



FOCO DE PROYECCIÓN



NEW!



GRAN AUTONOMÍA
3.7V 1800mAh

ACCESORIO PARED Y SUELO

	K°	Ref	PVPR
APLIQUE SOLAR VALLA	3200K	APQ-097	23,76€

- 100 Lm
- 1
- 90°
- IP 65
- ↓



BOTÓN ON/OFF

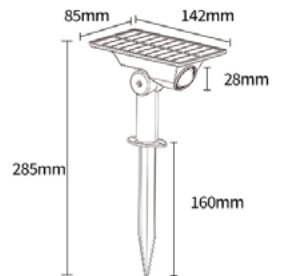

* Según la nueva normativa ERP ha habido un cambio en la medición de Lúmenes y vatios, pero sigue emitiendo la misma cantidad de luz. A medida que vayan entrando los nuevos modelos con ERP se irá actualizando en catálogo y cajas de color. Puede haber variación respecto la caja del producto (comprobar en ficha técnica), todos los datos en catálogo están correctos salvo error tipográfico.



Botón en la parte trasera

Battery
Li-ion
LITHIUM

GRAN
AUTONOMÍA
3.2V 2200mAh

ACLED-194 CCT **2 EN 1** DUAL COLOR

- MODO 1: Blanco frio - Brillo bajo
- MODO 2: Blanco frio - Alta luminosidad
- MODO 3: Blanco calido - Brillo bajo
- MODO 4: Blanco calido - Alta luminosidad
- MODO 5: OFF

ACLED-195 RGB

- MODO 1: Blanco frio
- MODO 2: Rojo
- MODO 3: Verde
- MODO 4: Azul
- MODO 5: Cambio gradual de color
- MODO 6: OFF

NEW PRICE!!



ACCESORIO PARED Y SUELO

	K°	Ref	PVPR
FOCO PICA JARDIN 24LED Bateria Li-Tio 18650 3.2V 2200mAh	3200K	ACLED-194	26,85€
FOCO PICA JARDIN 24LED Bateria Li-Tio 18650 3.2V 2200mAh	5000K	ACLED-195	26,85€

100 Lm 60 120° IP 65 DUAL COLOR RGB

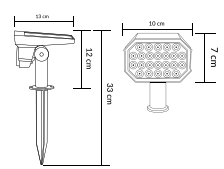

DISTANCIA SENSOR 4 -6 Metros - INSTALACIÓN EN PARED O SUELO

CONTROL POR MANDO A DISTANCIA

APLIQUE LED SOLAR PARED - PICA	Bateria 1800mAh*2 (3600mAh)	APQ-064	44,85 €
--------------------------------	-----------------------------	---------	---------

850 Lm IP 65 DUAL COLOR SENSOR PIR DE MOVIMIENTO ALTA LUMINOSIDAD AUTONOMÍA BATTERY Li-ion LITHIUM GRAN AUTONOMÍA 3.2V 3600mAh



FOCO PICA JARDIN

60 LEDS 2835



GRAN AUTONOMÍA
3.7V 2200mAh



ACLED-200..... 38,85€



Batería Li-Tio 18650 3.7V 2200mAh

MODOS DE ILUMINACIÓN

- Modo 1 (Pulsar 1 vez) Luz blanca 6000K
- Modo 2 (Pulsar 2 veces) Luz blanca 6000K brillante
- Modo 3 (Pulsar 3 veces) Luz cálida 3200K
- Modo 4 (Pulsar 4 veces) Luz cálida 3200K brillante
- Modo 5 : OFF

* Según la nueva normativa ERP ha habido un cambio en la medición de Lúmenes y vatios, pero sigue emitiendo la misma cantidad de luz. A medida que vayan entrando los nuevos modelos con ERP se irá actualizando en catálogo y cajas de color. Puede haber variación respecto la caja del producto (comprobar en ficha técnica), todos los datos en catálogo están correctos salvo error tipográfico.





Serie **Farolas y Campana**



Ø Base 48mm

FAROLA LED	30W	K°	Ref	PVPR
		5000K	FRL-003	56,31€

30 W 3000 Lm 230 V 1 120° IP 65 >0,9 FP

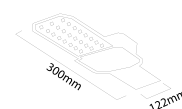

Ø Base 48mm

FAROLA LED	50W	K°	Ref	PVPR
		3200K	FRL-004	86,70€

50 W 5000 Lm 230 V 1 120° IP 65 >0,9 FP

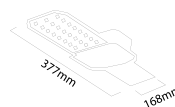

Ø Base 60mm

FAROLA LED	100W	K°	Ref	PVPR
		3200K	FRL-007	173,34€

100 W 10.000 Lm 230 V 1 120° IP 65 >0,9 FP

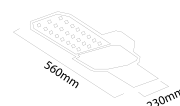

Ø Base 48mm

FAROLA LED	30W	K°	Ref	PVPR
		3200K	FRL-036	78,96€
		4200K	FRL-024	78,96€
		5000K	FRL-025	78,96€

30 W 3500 Lm 230 V 1 120° IP 65 >0,9 FP

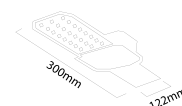

Ø Base 48mm

FAROLA LED	50W	K°	Ref	PVPR
		3200K	FRL-026	118,35€
		4200K	FRL-027	118,35€
		5000K	FRL-028	118,35€

50 W 5500 Lm 230 V 1 120° IP 65 >0,9 FP

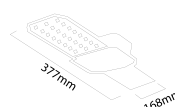

Ø Base 60mm

FAROLA LED	100W	K°	Ref	PVPR
		3200K	FRL-037	241,98€
		4200K	FRL-029	241,98€
		5000K	FRL-030	241,98€

100 W 10.500 Lm 230 V 1 120° IP 65 >0,9 FP

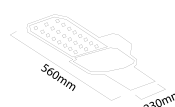

Soporte Articulado para Farolas

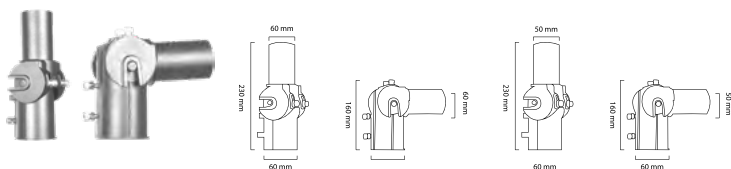

ACLED-102 50-60 cm 46,08€ Válido para FRL-024/025/026/027/028 y FRL-010/011/012/013 FRL-003, 004, 036

ACLED-103 60-60 cm 50,37€ Válido para FRL-029/030

Soporte Acople para Farolas



ACLED-104 50-60 cm

24,54€

Válido para FRL-026/027/028/029/030 y FRL-010/011

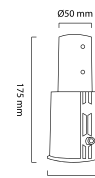

ACLED - 171
Soporte para farola FRL-024 a FRL-030
Ø 50mm 46 cm
16,86€



ACLED - 166
Soporte para farola FRL-024 a FRL-030
Ø 50mm 46cm
16,86€



Farola UFO

3potencias

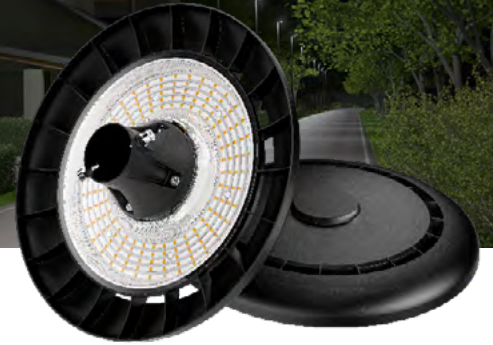

3POTENCIAS
80W/100W/120W

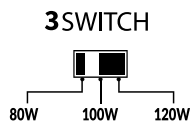

3 en 1 TRES TIPOS DE LUZ
EN LA MISMA LUMINARIA

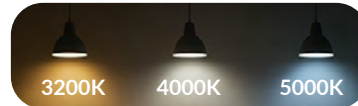

NEW!



Ø Base 63mm - Aluminio

FAROLA LED UFO 3POTENCIAS 80W / 100W / 120W

K°	Ref	PVPR
3CCT 	FRL-059	179,85€



* Según la nueva normativa ERP ha habido un cambio en la medición de Lúmenes y vatios, pero sigue emitiendo la misma cantidad de luz. A medida que vayan entrando los nuevos modelos con ERP se irá actualizando en catálogo y cajas de color. Puede haber variación respecto la caja del producto (comprobar en ficha técnica), todos los datos en catálogo están correctos salvo error tipográfico.

Serie campanas



	100W	K°	Ref	PVPR
CAMPANA LED INDUSTRIAL ERIAL	100W	4200K	CMP-005	89,70€
CAMPANA LED INDUSTRIAL ERIAL	100W	5000K	CMP-006	89,70€

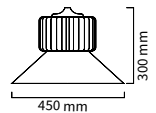

CAMPANA LED INDUSTRIAL ERIAL	150W	4200K	CMP-001	105 €
CAMPANA LED INDUSTRIAL ERIAL	150W	5000K	CMP-002	105 €

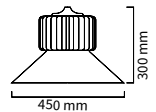

CAMPANA LED INDUSTRIAL ERIAL	200W	5000K	CMP-004	110,40€
------------------------------	------	-------	---------	---------

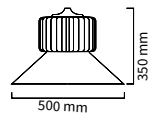

Max. 4 lámparas de 30W



PORTALÁMPARAS	4xE27 - E40	ACLED-010	22,77€
---------------	-------------	-----------	--------

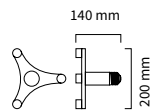

PORTALAMPARA REDUCTOR	E40 A E27	PORTLM-003	2,70€
-----------------------	-----------	------------	-------



Max. 4 lámparas de 30W

COMBINAR CON 4 Lámparas DE 30W Y ADAPTADOR 4XE27-E40 (ACLED-010)



CAMPANA INDUSTRIAL ALUMINIO	Ø 52cm E40	ACLED-024	61,23€
-----------------------------	------------	-----------	--------

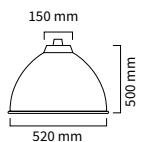



Campana UFO 3 potencias

3 POTENCIAS
120W/150W/200W

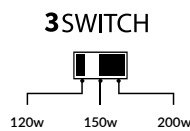

3 en 1 TRES TIPOS DE LUZ EN LA MISMA LUMINARIA



High Efficiency
170Lm/w

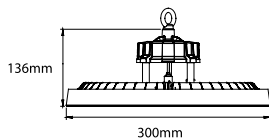

LIFUD®

	K°	Ref	PVPR
CAMPANA LED UFO REGULABLE	3CCT	CMP-027	137,94€

120 W 150 W 200 W
230 V 4 120° 65 IP 08 IK >0,9 FP 1-10V ↓



LIFUD®

	K°	Ref	PVPR
CAMPANA LED UFO REGULABLE	3CCT	CMP-028	192,36€

120 W 150 W 200 W
230 V 4 120° 65 IP 08 IK >0,9 FP 1-10V
 SENSOR PIR MOVIMIENTO



	Ref	PVPR
CONTROL REMOTO PARA CMP-027/028	ACLED-514	72,60€

* Según la nueva normativa ERP ha habido un cambio en la medición de Lúmenes y vatios, pero sigue emitiendo la misma cantidad de luz. A medida que vayan entrando los nuevos modelos con ERP se irá actualizando en catálogo y cajas de color. Puede haber variación respecto la caja del producto (comprobar en ficha técnica), todos los datos en catálogo están correctos salvo error tipográfico.



NEW PRICE!!

High Efficiency
170Lm/w

LIFUD
Led Driver



CAMPANA LED UFO	REGULABLE	100W	K°	Ref	PVPR
			5000K	CMP-020	111 €

100 W 17000 Lm 230 V 4 120° >0,9 FP 1-10v

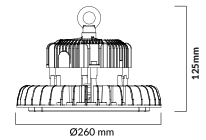

CAMPANA LED UFO	REGULABLE	150W	4000K	CMP-021	117 €
CAMPANA LED UFO	REGULABLE	150W	5000K	CMP-022	117 €

150 W 25500 Lm 230 V 4 120° >0,9 FP 1-10v

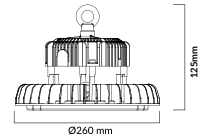

CAMPANA LED UFO	REGULABLE	200W	5000K	CMP-023	125,85€
-----------------	-----------	------	-------	---------	---------

200 W 34000 Lm 230 V 4 120° >0,9 FP 1-10v

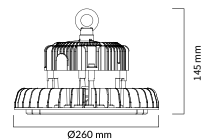

NEW PRICE!!

LED CHIP
ALTA CALIDAD

High Efficiency
140Lm/w

LIFUD
Led Driver



CAMPANA LED UFO	REGULABLE	100W	4200K	CMP-015	98,40€
-----------------	-----------	------	-------	---------	--------

100 W 14000 Lm 230 V 4 120° >0,9 FP 1-10v

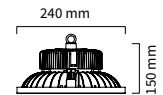

CAMPANA LED UFO	REGULABLE	200W	4200K	CMP-018	113,70€
-----------------	-----------	------	-------	---------	---------

200 W 28000 Lm 230 V 4 120° >0,9 FP 1-10v

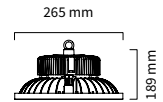

Regulador 1-10v para campana



REGULADOR LED CAMPANA 1-10V + CAJA DE SUPERFICIE	Ref	PVPR
	ACLED-314	109,56€

NEW PRICE!!



INCLUYE MANDO 360° DETECCIÓN

Potencia Máx: 1000W LED - 2000W Incandescente 10-2000lux - máx.10mts radio

SENSOR MOVIMIENTO.HF PARA CAMPANA UFO **5'8GH 360° 10mt** ACLED-145 38,85€

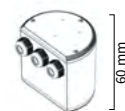

INSTALACIÓN MÁXIMA 3 CAMPANAS

15w - 100mA PARA CMP-020/021/022/023/015/018/014

EMERGENCIA KIT PARA CAMPANA UFO **IP65** EMR-025 142,89€



SISTEMA AUTOTEST

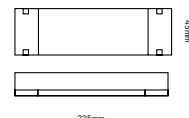

Voltaje entrada 10-22.5 V - 5mA



CONVERTIDOR SEÑAL **DALI A PWM** **IP67** ACLED-176 46,74€



Policarbonato
Compatible c/ CMP-015-018-027 - Apertura 90°

REFRACTORA PARA CAMPANA UFO SAMSUNG **90° 260mm** CMP-019 44,04€

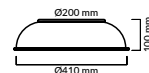

Para Campanas UFO Compatible para CMP-027

SOPORTE AJUSTABLE TIPO "U" UFO ACLED-146 28,71€





Serie **Emergencia y sensores**



Luz de emergencia industrial 2x10w

- Hora de emergencia: >1,5horas
- Duración de la batería: 6,4V - 3400mAh
- Tiempo de carga: 24horas
- Grado IP: IP65
- Lúmenes: 1000Lm
- CCT (K): 6000K



NEW!

SISTEMA AUTOTEST

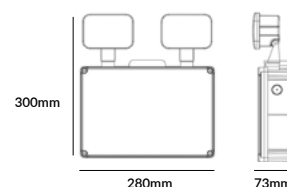

LUZ EMERGENCIA LED DOBLE INDUSTRIAL	2x10w 1000Lm	Ref	PVPR
		EMR-030	144,24€



Serie KIT DE EMERGENCIA

NEW!



SISTEMA AUTOTEST



PARA DOWNLIGHTS Y PANEL LED

KIT DE EMERGENCIA PARA DOWNLIGHTS Y PANEL LED	3 - 60w	Ref	PVPR
		EMR-035	40,95€

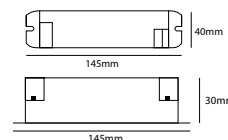

NEW!



SISTEMA AUTOTEST



PARA TUBO DE LED

KIT DE EMERGENCIA PARA TUBO DE LED	3 - 40w	Ref	PVPR
		EMR-036	96,45€

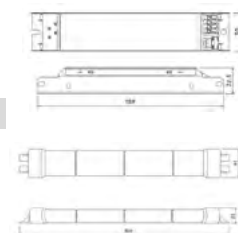

PARA CAMPANAS UFO

INSTALACIÓN MÁXIMA 3 CAMPANAS

CMP-020/021/022/023/015/018/014

KIT DE EMERGENCIA PARA CAMPANA UFO LED ESTANCA	15w	Ref	PVPR
		EMR-025	142,89€

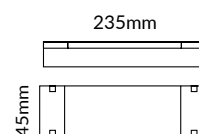

SISTEMA AUTOTEST



VIDEO DE INSTALACIÓN CON CAMPANAS

* Según la nueva normativa ERP ha habido un cambio en la medición de Lúmenes y vatios, pero sigue emitiendo la misma cantidad de luz.

A medida que vayan entrando los nuevos modelos con ERP se irá actualizando en catálogo y cajas de color.

Puede haber variación respecto la caja del producto (comprobar en ficha técnica), todos los datos en catálogo estan correctos salvo error tipográfico.

Serie emergencia superficie

NEW PRICE!!



Caja ABS/Dif. PC - Autonomía 60'	Permanent&NoPermanent	Ref	PVPR
EMERGENCIA LED PERMANENT & NO PERMANENT	75LUM IP20 0.75W	EMR-009	22,80€
EMERGENCIA LED PERMANENT & NO PERMANENT	150LUM IP20 1.5W	EMR-010	32,85€
EMERGENCIA LED PERMANENT & NO PERMANENT	250LUM IP20 2W	EMR-011	36,93€
EMERGENCIA LED PERMANENT & NO PERMANENT	400LUM IP20 4W	EMR-012	44,70€

0,75 W
1,5 W
2 W
4 W
230 V
50
IP 20

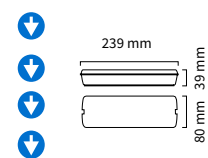

Caja ABS/Dif. PC - Autonomía 60'	Permanent&NoPermanent	Ref	PVPR
EMERGENCIA LED AUTO-TEST PERMANENT & NO PERMANENT	75LUM IP20 0.75W	EMR-017	33,72€
EMERGENCIA LED AUTO-TEST PERMANENT & NO PERMANENT	150LUM IP20 1.5W	EMR-018	42,42€
EMERGENCIA LED AUTO-TEST PERMANENT & NO PERMANENT	250LUM IP20 2W	EMR-019	45,30€
EMERGENCIA LED AUTO-TEST PERMANENT & NO PERMANENT	400LUM IP20 4W	EMR-020	50,40€



SISTEMA AUTOTEST

0,75 W
1,5 W
2 W
4 W
230 V
50
IP 20

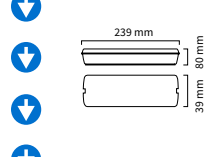

MARCO DE EMPOTRAR TECHO PARA EMERGENCIA LED	EMR-002	7,05€
CAJA Y MARCO EMPOTRAR PARED EMERGENCIA LED	EMR-003	10,65€
CAJA ESTANCA IP65	EMR-006	18,90€

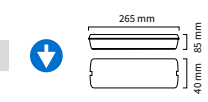
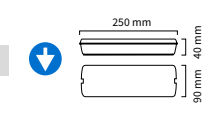
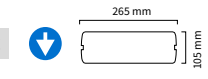



PEGATINAS SALIDA EMERGENCIA



210x68mm

PEGATINA SALIDA DE EMERGENCIA IZQUIERDA EMR-015 2,70€



210x68mm

PEGATINA SALIDA DE EMERGENCIA DERECHA EMR-016 2,70€



210x68mm

PEGATINA SALIDA DE EMERGENCIA ATRÁS EMR-014 2,70€



210x68mm

PEGATINA SALIDA EMR-013 2,70€



SISTEMA AUTOTEST

Emergencia superficie estanco IP65

Nuevo diseño

ELEGANTE / MINIMALISTA

Caja ABS/Dif. PC - Autonomía 60'

No Permanente

Ref

PVPR

EMERGENCIA LED NO PERMANENTE	150LUM IP65	3W	EMR-031	32,85€	↓
EMERGENCIA LED NO PERMANENTE	250LUM IP65	4W	EMR-032	37,71€	↓
EMERGENCIA LED NO PERMANENTE	400LUM IP65	5W	EMR-033	50,85€	↓

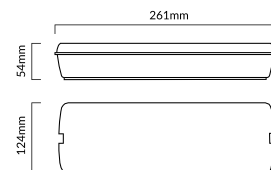

	Ref	PVPR
Marco de empotrar de emergencia	EMR-034	4,50€

* Según la nueva normativa ERP ha habido un cambio en la medición de Lúmenes y vatios, pero sigue emitiendo la misma cantidad de luz.

A medida que vayan entrando los nuevos modelos con ERP se irá actualizando en catálogo y cajas de color.

Puede haber variación respecto la caja del producto (comprobar en ficha técnica), todos los datos en catálogo están correctos salvo error tipográfico.

Serie emergencia superficie

EMERGENCIA DE INTERIOR IP20



Battery
Li-ion 3,7V
1500mAh

Permanent & NoPermanent - Aislamiento CLASE II -
AUTONOMÍA 60' - Li-ion 3,7V/1.5aH

Ref

EMERGENCIA CIRCULAR SUPERFICIE PERMANENT & NO PERMANENT

EMR-037

40,68€

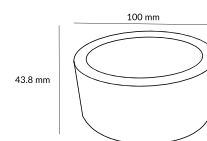

EMERGENCIA DE EXTERIOR IP65



Battery
Li-ion 3,7V
1500mAh

Permanent & NoPermanent - Aislamiento CLASE II -
AUTONOMÍA 60' - Li-ion 3,7V/1.5aH

Ref

EMERGENCIA CIRCULAR SUPERFICIE PERMANENT & NO PERMANENT

EMR-038

49,68€

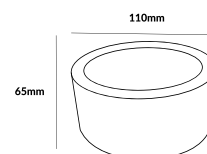



NEW PRICE!!

Battery
Li-ion
LITHIUM
Li-ion 3,7V
1500mAh



SISTEMA
AUTOTEST

Permanent & NoPermanent - Aislamiento CLASE II -
AUTONOMÍA 60' - Li-ion 3,7V/1.5aH

LÁMPARA DE EMERGENCIA LED EMPOTRAR AUTO-TEST

Ref PVPR

EMR-021 41,25€

8 W 400 Lm 230 V 40 IP 20 15 Leds

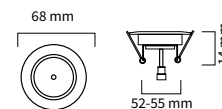

SISTEMA
AUTOTEST

Permanent & NoPermanent - Aislamiento CLASE II -
AUTONOMÍA 60' - Li-ion 3,7V/1.5aH

EMERGENCIA LED MINI CUADRADO BLANCO EMPOTRAR

Ref PVPR

EMR-022 41,85€

8 W 400 Lm 230 V 40 IP 20 15 Leds

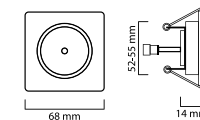

ARO PARA EMERGENCIA MINI
EMR-021



EMR-028 6,48€
Negro



EMR-027 6,48€
Aluminio

DISPONIBLE ARO DE SUSTITUCION

Aro sustitución:
Negro - Aluminio



NEW!

Battery
Li-ion
LITHIUM
Li-ion 3,7V
1500mAh

Permanent & NoPermanent -
AUTONOMÍA 60' - Li-ion 3,7V/1.5aH

LUZ EMERGENCIA LED EMPOTRAR

5w 250Lm

Ref

Ref

EMR-029 40,80€

5 W 250 Lm 230 V IP 20

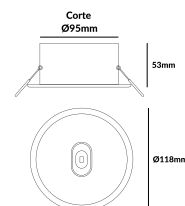



Serie **Sensores**

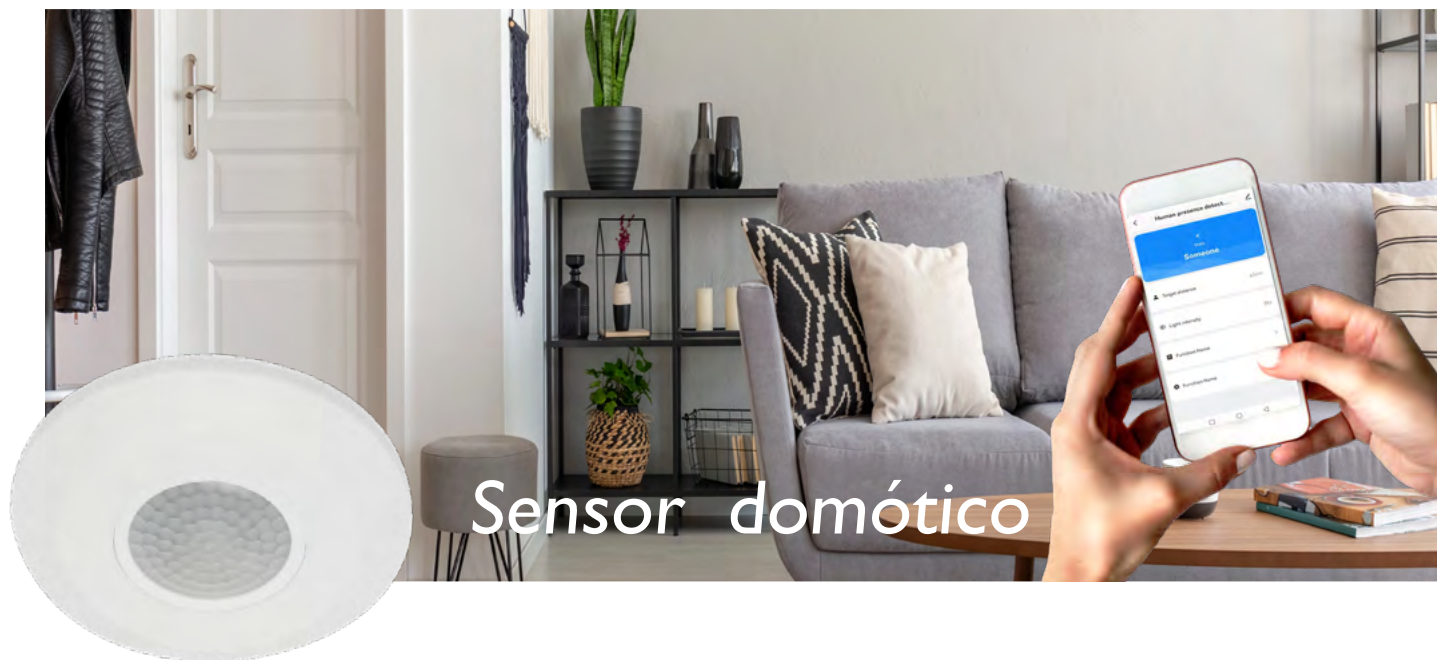

Sensor domótico

NEW!



Altura de instalación 2,2 - 4m
 Distancia detección 6 mts <10-2000lux 5seg - 60min

SENSOR DE MOVIMIENTO INFRARROJO SUPERFICIE TUYA **2000W** Ref ACLED-515 58,74€



tuya

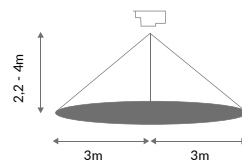

CORTE Ø80mm

Altura de instalación 2 - 4m
 0-1000lux 5seg - 60min
 Diámetro de detección de presencia: 2-6 m.
 Diámetro de detección de movimiento y micro movimiento: 8 m

NEW!



SENSOR PRESENCIA EMPOTRABLE 2,4GHz TUYA **WiFi** ACLED-477 143,16€



tuya

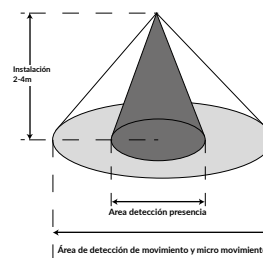
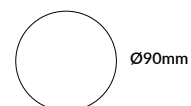



SENSORES - ALTA FRECUENCIA

SENSOR DE MICROONDAS

Altura de instalación: Pared 1.5 - 3.5 mts Techo 2 - 8 mts

Distancia detección Techo: 2-16 mts Pared: 5 - 15mts - 3-2000lux - 10seg - 12min



SENSOR DE MOVIMIENTO ALTA FRECUENCIA 5.8Ghz 300W ACLED-008 25,11€

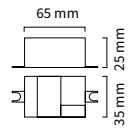

SENSOR DE MICROONDAS

Distancia detección PARED 5-15mts - TECHO 2-16 mts - 25 - 2000lux - 5seg - 30min

300w LED - 400w Fluorescente - 800w Incandescente



SENSOR DE MOVIMIENTO ALTA FRECUENCIA AREA LUX MINI 5.8Ghz 300W ACLED-089 28,71€

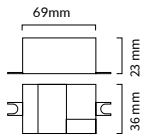

SENSOR DE MICROONDAS

Distancia detección PARED 5-15mts - TECHO 1-8 mts - <3-2000lux - 10seg - 12min

120w LED



SENSOR DE MOVIMIENTO ALTA FRECUENCIA AREA LUX MINI 5.8Ghz 120W ACLED-507 20,16€

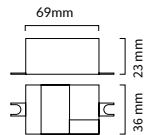

DISTANCIA REGULABLE

Altura instalación: 2-6m

Distancia detección REGULABLE 1-8mts - 3-2000lux - 10seg - 12min



SENSOR DE MOVIMIENTO ALTA FRECUENCIA 5.8Ghz 1000W ACLED-085 30,30€

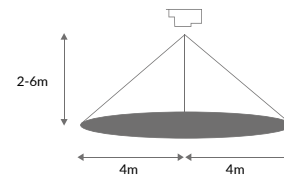

SENSORES - REAL PRESENCIA

SENSOR PRESENCIA

Altura de instalación: 2,5m - 4m

Señal de movimiento máxima de 4-5m (radio) (Movimiento de la mano, movimiento de la cabeza)

Señal de respiración de 2-3 m (radio).- 12min



SENSOR DE PRESENCIA EMPOTRADO 360° 400W LED IP65 ACLED-485 79,86€

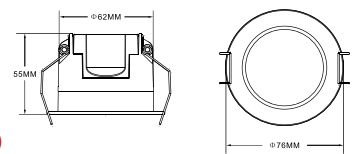

Ref PVPR

Altura de instalación 2 - 2,5m

Distancia de DETECCIÓN REGULABLE 1,2 - 4,6m



SENSOR DE PRESENCIA SUPERFICIE 360° 1000W LED IP65 ACLED-486 63,42€

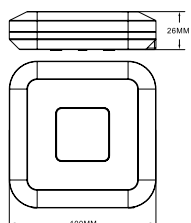

NEW!



CORTE Ø70mm

Altura de instalación 2 - 2,5m

Distancia de DETECCIÓN REGULABLE 1,2,4,6m

Lux regulable 10/30/100 lux

10 seg - 15min

SENSOR DE PRESENCIA SUPERFICIE/EMPOTRADO

360° 400W LED IP20

Ref

PVPR

ACLED-491

77,46€

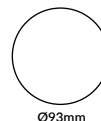

Ø93mm

SUPERFICIE

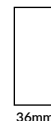

36mm

EMPOTRADO



8mm

SENSOR DE PRESENCIA



Altura de instalación 2,2 - 4m

Distancia detección 20mts 3 - 2000lux 10seg - 15min

SENSOR DE PRESENCIA 2 EN 1 | EMPOTRADO / SUPERFICIE | 1000W

ACLED-081

35,07€

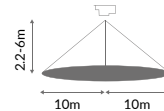
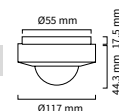

Sensor de presencia 6mts - Distancia máxima de movimiento 20mts 3 - 2000lux 10seg - 30min

SENSOR DE PRESENCIA INFRARROJO

1000W

ACLED-093

38,25€

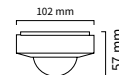

Sensor caja estanco

NEW!



Altura de instalación 1 - 1,8m

Distancia de DETECCIÓN 10m

SENSOR DE MOVIMIENTO ESTANCO | 190° 500W LED IP65

Ref

PVPR

ACLED-478

31,65€

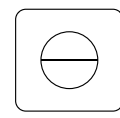
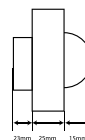

85mm

NEW!



INCLUYE MANDO

Altura de instalación 1 - 1,8m

Distancia de DETECCIÓN 10m

SENSOR DE MOVIMIENTO INFRARROJO CAJA ESTANCA | 180-360° 1000W LED IP65

Ref

PVPR

ACLED-484

42,30€

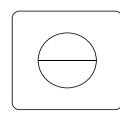
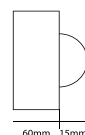

85mm

* Según la nueva normativa ERP ha habido un cambio en la medición de Lúmenes y vatios, pero sigue emitiendo la misma cantidad de luz.

A medida que vayan entrando los nuevos modelos con ERP se irá actualizando en catálogo y cajas de color.

Puede haber variación respecto la caja del producto (comprobar en ficha técnica), todos los datos en catálogo están correctos salvo error tipográfico.



SENSORES - INFRARROJO EMPOTRADO

NEW!



CORTE Ø62mm - Altura instalación: 2-4m
Distancia diámetro máxima 6mts 5 - 2000lux 10seg - 15min

SENSOR MOVIMIENTO INFRARROJO EMPOTRADO 300W ACLED-032 18,93€

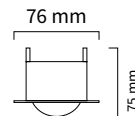
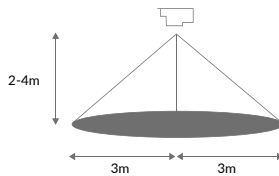

NEW!



CORTE Ø42mm - Altura instalación: 2,2-4m
Distancia diámetro máxima 6mts 3 - 2000lux 10seg - 15min

SENSOR MOVIMIENTO INFRARROJO EMPOTRADO 300W ACLED-046 19,71€

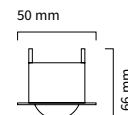
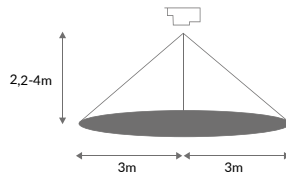

NEW!



CORTE Ø65mm
Distancia diámetro máxima 8mts - 3-2000lux
10seg - 7min - Máx. 1000W LED - Altura de instalación 2,2 - 4m

SENSOR MOVIMIENTO INFRARROJO EMPOTRADO 1000W ACLED-108 21,60€



Ref PVPR

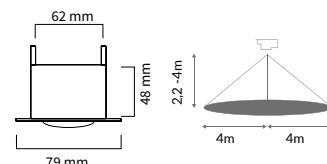

NEW!



Altura de instalación 2 - 4m
Distancia diámetro máxima 6mts 10 - 2000lux - 5/30seg-1/3/5/8min - 180° - 360°

SENSOR MOVIMIENTO INFRARROJO MINI EMPOTRADO 200W ACLED-033 17,91€

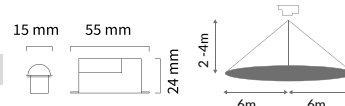

NEW!



CORTE Ø63-66mm
Altura de instalación 1,8 - 4m
Distancia de DETECCIÓN 8m

SENSOR DE MOVIMIENTO INFRARROJO EMPOTRADO 360° 600W LED IP65 ACLED-470 17,07€



Ref PVPR

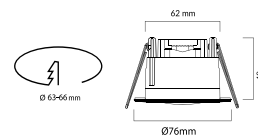

NEW!



CORTE Ø67mm
Altura de instalación: 2,2 - 4mts
Distancia detección Ø8mts

SENSOR DE MOVIMIENTO INFRARROJO EMPOTRADO 360° 300W LED IP20 ACLED-480 19,02€



Ref PVPR

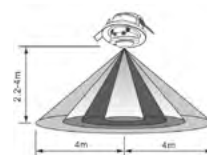
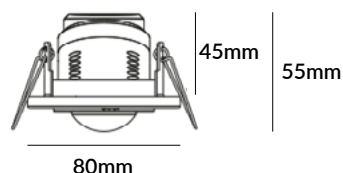

Altura de instalación:
2,2 - 4mts



NEW!

CORTE Ø12mm

Distancia diámetro máxima 3-6mts - 10 - 2000lux
5seg - 8min - Máx. 120W LED

SENSOR MOVIMIENTO INFRARROJO EMPOTRADO 12-24V 120/360° 120W ACLED-508 25,44€

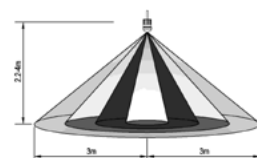

Altura de instalación: 2,2-4m

SENSOR MOVIMIENTO EMPOTRADO PARED



Distancia diámetro máxima 8mts - 3-2000lux
10seg - 7min - Máx. 200W LED

SENSOR MOVIMIENTO INFRARROJO EMPOTRADO PARA CAJA 200W ACLED-120 27,45€

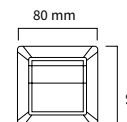

Distancia diámetro máxima 9mts 3 - 2000lux 10seg - 7min

SENSOR MOVIMIENTO INFRARROJO PARA CAJA UNIVERSAL 200W ACLED-084 27,45€

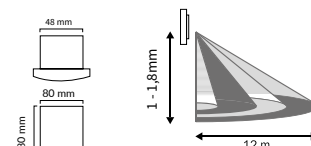

SENSORES - INFRARROJO EMPOTRADO / SUPERFICIE

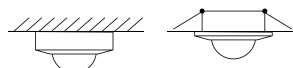

SENSOR 2 EN 1 EMPOTRADO SUPERFICIE



CORTE Ø76mm

Altura de instalación 2,2 - 6m

Distancia diámetro máxima 6mts - 10-2000lux
10seg - 7min - Máx. 1000W LED/ 500W INCANDESCENTE

SENSOR MOVIMIENTO INFRARROJO EMPOTRADO / SUPERFICIE 1000W ACLED-107 22,44€

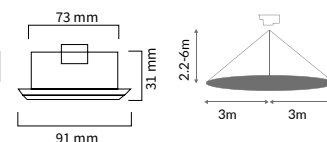

DISTANCIA REGULABLE

CORTE Ø54,5mm

Altura de instalación 2,2 - 4m

Distancia diámetro **REGULABLE** máxima 16mts - 10-2000lux -
10seg - 7min - Máx. 1000W LED/ 2000W INCANDESCENTE

SENSOR MOVIMIENTO INFRARROJO EMPOTRADO / SUPERFICIE 1000W ACLED-197 32,34€

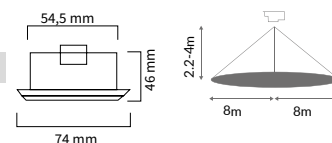

NEW!

CORTE Ø63-66mm

Altura de instalación 2,2 - 4m

Distancia de DETECCIÓN 8m

SENSOR DE MOVIMIENTO INFRARROJO SUPERFICIE/EMPOTRAR 360° 600W LED IP20 ACLED-472 18,84€

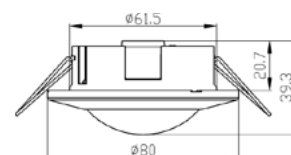

* Según la nueva normativa ERP ha habido un cambio en la medición de Lúmenes y vatios, pero sigue emitiendo la misma cantidad de luz.

A medida que vayan entrando los nuevos modelos con ERP se irá actualizando en catálogo y cajas de color.

Puede haber variación respecto a la caja del producto (comprobar en ficha técnica), todos los datos en catálogo están correctos salvo error tipográfico.



SENSORES - INFRARROJO SUPERFICIE

DISTANCIA REGULABLE



Altura de instalación 2,2 - 4m

Distancia detección **REGULABLE** 2-20mts 10 - 2000lux 10seg - 10min

SENSOR DE MOVIMIENTO INFRARROJO SUPERFICIE 300W ACLED-036 35,94 €

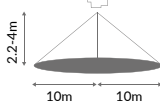
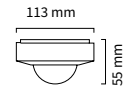

DISTANCIA REGULABLE



Altura de instalación 2,2 - 4m

Distancia detección **REGULABLE** 2-6 mts 10 - 2000lux 10seg - 10min

SENSOR DE MOVIMIENTO INFRARROJO SUPERFICIE SLIM 1000W ACLED-037 22,77€

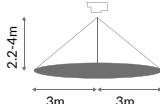
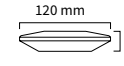

Altura de instalación 2,2 - 4m

Distancia diámetro máxima 8mts - <3-2000lux
10seg-15min - Máx. 300W LED/ 1000W INCANDESCENTE



SENSOR MOVIMIENTO INFRARROJO SUPERFICIE 300W ACLED-106 19,17€

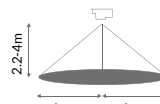
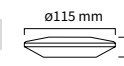

Altura de instalación 2,2 - 4m

Distancia detección 8 mts 10 - 2000lux 10seg - 7min



SENSOR DE MOVIMIENTO INFRARROJO MINI 100W ACLED-086 14,25€

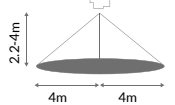
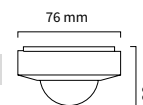

DISTANCIA REGULABLE

NEW!



Altura de instalación 2,2 - 4m

Distancia diámetro **REGULABLE** detección 16mts 3 - 2000lux 10seg - 3min

SENSOR DE MOVIMIENTO INFRARROJO MINI SUPERFICIE 1000W ACLED-198 32,34€

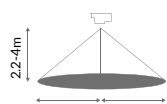
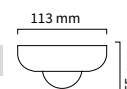

Altura de instalación 2,2 - 4m

Distancia detección 6mts 3 - 2000lux 10seg - 7min



SENSOR DE MOVIMIENTO INFRARROJO SUPERFICIE 300W ACLED-047 16,71€

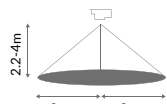
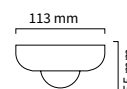

Altura de instalación 4 - 10m

Distancia detección 20 mts 3 - 2000lux 10seg - 30min



SENSOR DE MOVIMIENTO INFRARROJO SUPERFICIE SLIM 1000W ACLED-082 34,65€

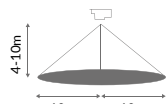
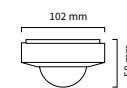

NEW!



TECHO PARED

Altura de instalación 1,8 - 2,5m
Distancia detección 12mts 3 - 2000lux 10seg - 15min

SENSOR DE MOVIMIENTO INFRARROJO 600W ACLED-471 25,62€

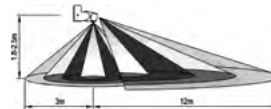

DISTANCIA REGULABLE



Altura de instalación 1,8 - 2,5m
Distancia detección REGULABLE 5 - 12mts 3 - 2000lux 10seg - 7min

SENSOR DE MOVIMIENTO INFRARROJO 300W ACLED-031 17,91€

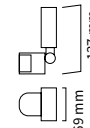
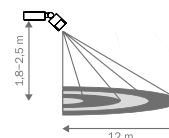

Altura de instalación 1,8 - 2,5m

Distancia detección 10 mts 3 - 2000lux 10seg - 15min

SENSOR DE MOVIMIENTO INFRARROJO SUPERFICIE SLIM 300W ACLED-080 19,50€

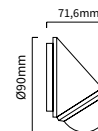
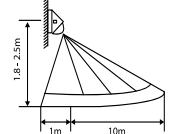

Altura de instalación 1,8 - 2,5m

Distancia detección 12mts 3 - 2000lux 10 - 15min

SENSOR DE MOVIMIENTO INFRARROJO 300W ACLED-028 22,77€

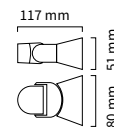
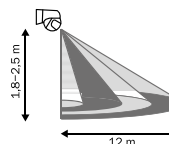

Altura de instalación 1,8 - 2,5m

Distancia detección 12mts 3 - 2000lux 10seg - 7min

SENSOR DE MOVIMIENTO INFRARROJO 300W ACLED-027 16,26€

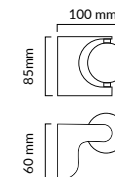
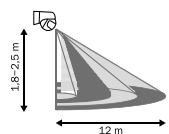

Altura de instalación 1,8 - 2,5m

Distancia detección 12mts 3 - 2000lux 10seg - 7min

SENSOR DE MOVIMIENTO INFRARROJO 300W ACLED-026 19,17€

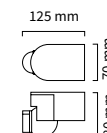
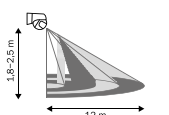

Altura de instalación 1,8 - 2,5m

Distancia detección 12mts 10 - 2000lux 10seg - 15min

SENSOR DE MOVIMIENTO INFRARROJO SUPERFICIE 300W ACLED-035 19,95€

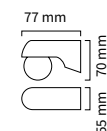
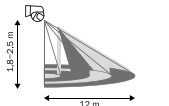



NEW!

Altura de instalación 1,8 - 2,5m
Distancia detección 12mts 3 - 2000lux 10seg - 15min

SENSOR DE MOVIMIENTO INFRARROJO SUPERFICIE 60W(12v) - 120w (24v) ACLED-506 20,61€

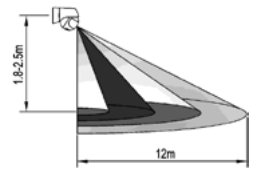

Altura de instalación: 1,8-2,5m



Altura de instalación 2,2 - 4m
Distancia detección 20mts 10 - 2000lux
Tiempo de retraso: Min.10sec± 3sec
Max.7min ± 2min

MINI

SENSOR MOVIMIENTO INFRARROJO MINI SUPERFICIE 20m 360° 300W ACLED-218 27,72€



Ref PVPR

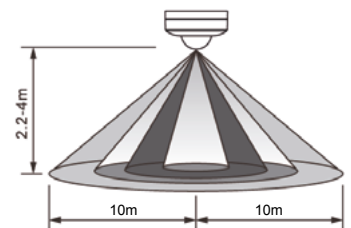
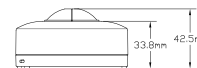
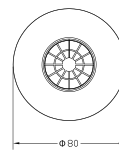

Altura de instalación 2,2 - 4m
Distancia detección 2-10mts **REGULABLE**
Tiempo de retraso: Min.10sec± 3sec
Max.7min ± 2min

MINI

SENSOR MOVIMIENTO INFRARROJO MINI SUPERFICIE 100W ACLED-219 17,91€

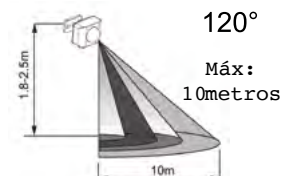
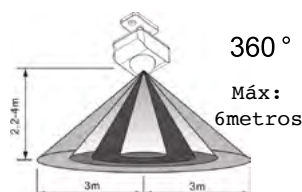
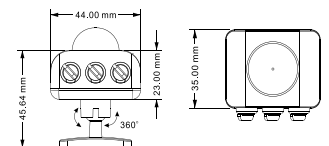

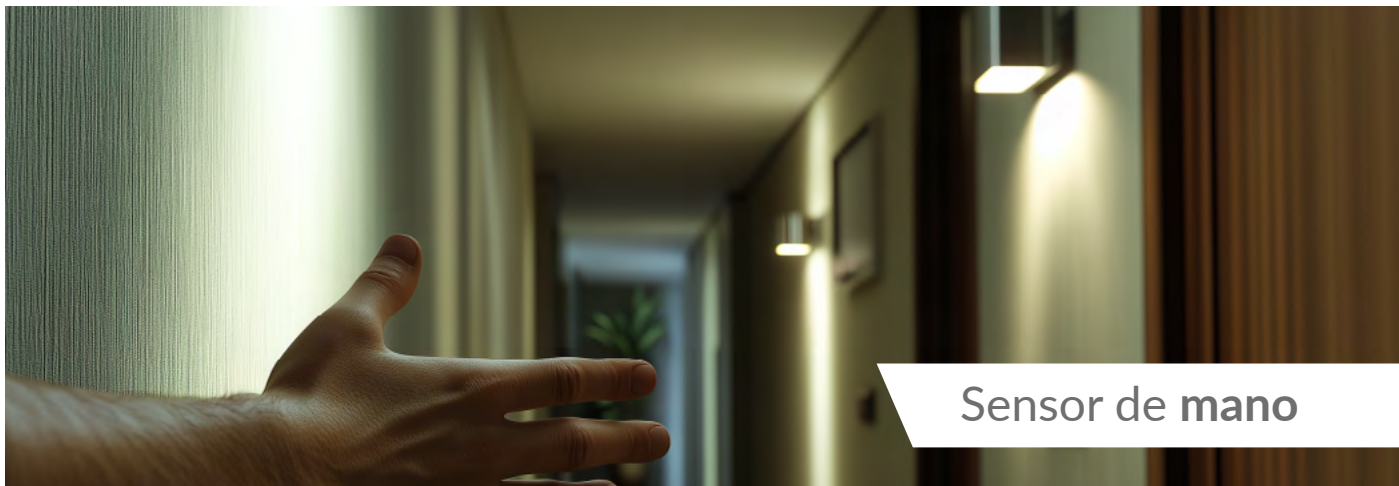

Sensor de mano



Distancia de DETECCIÓN 5-6cm

SENSOR DE ON/OFF MOVIMIENTO MANO 360° 500W LED IP20

Ref

PVPR

ACLED-473

17,43€



ON/OFF
SENSOR DE
MOVIMIENTO
MANO



Sensor de puerta



Distancia de DETECCIÓN 5-6cm

SENSOR DE ON/OFF MOVIMIENTO PUERTA 360° 500W LED IP20

Ref

PVPR

ACLED-474

17,43€



ON/OFF
SENSOR DE
MOVIMIENTO
PUERTA

Sensor de Escalera

NEW!

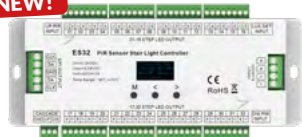

CONTROLADOR LUZ ESCALERA CON SENSOR PIR

Ref	PVPR
CONTR-102	283,20€



32 CANALES / 1A (CANAL)

Incluye:

- PIR Sensor 2Ud (1,2mts)
- Sensor de luz diurna
- Cable sensor PIR (5mts)
- Número de luces de escalera ajustable, máx. 32 peldaños
- 8 velocidades de iluminación graduadas ajustables
- 4 modos de iluminación de trabajo opcionales
- Dos controladores de luz de escalera pueden funcionar en cascada
- Control de interruptor pulsador opcional

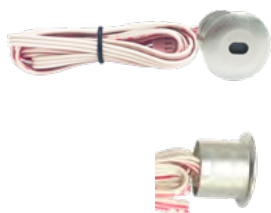

CABEZAL SENSOR DE MOVIMIENTO PIR

Ref	PVPR
CONTR-103	26,82€

SENSOR CREPUSCULAR



Distancia diámetro máxima 8mts - 3-500lux
 Temporizador incorporado de 1 a 9 horas - Máx. 200W LED

SENSOR CREPUSCULAR SUPERFICIE 10A ACLED-094 22,41€

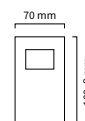

5 - 50 lux

SENSOR CREPUSCULAR 15A ACLED-083 16,89€



5 - 50lux

SENSOR CREPUSCULAR 10A ACLED-030 9,96€

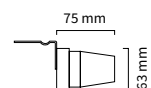

180° DETECCIÓN - 5-15 lux

SENSOR CREPUSCULAR 6A ACLED-029 7,80€

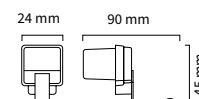

Temporizador incorporado de 1 a 12 horas -
 Máx. 60W LED - 100W INCANDESCENTE 5-15 lux

SENSOR LUZ CREPUSCULAR TEMPORIZADO E27 60W ACLED-034 19,71€

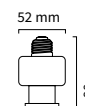

Serie Linternas profesionales

- Alta luminosidad
- Gran autonomía
- Carga por USB

- Diferentes modos de luz
- Imán de sujeción
- Gran resistencia



BATERIAS MEJORADAS



20 uds

120 LM

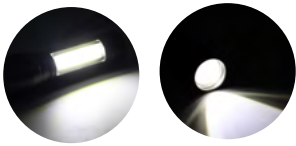

QUITAR SELLO BATERÍAS

LINTERNA MANO ZOOM

91cm BATERÍA LITIO 120Lm Micro-usb

Ref

PVPR

LNT-002

8,94€



Carga por USB

- CABLE INCLUIDO
- BATERÍA LI-TIO 14500 - 700mAh



GRAN AUTONOMÍA
Batería 700mAh

RECARGABLE CARGA USB



Carga por USB

Botón On/Off



Luminaria lateral

- Zoom

+ Zoom

Luminaria principal

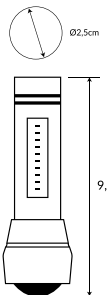

QUITAR SELLO BATERÍAS

LINTERNA MANO/BOLSILLO

BATERÍA DE LITIO 2000mAh Usb

Ref

PVPR

LNT-004

24,45€



12 ud

400 LM



Carga por USB

- CABLE INCLUIDO
- BATERÍA LI-TIO 5v- 18650 - 2000 mAh



GRAN AUTONOMÍA
Batería 2000mAh

RECARGABLE CARGA USB



2 en 1
DOS LUMINARIAS EN UNA LINTERNA

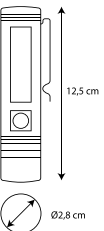

QUITAR SELLO BATERÍAS

LINTERNA MANO/BOLSILLO **BATERÍA DE LITIO** 2000mAh Usb LNT-007 29,70€

Carga por Tipo-C **USB** - CABLE INCLUIDO
- BATERÍA LI-TIO
3.7V - 700mAh - 16340

GRAN AUTONOMÍA
Batería 700mAh
RECARGABLE CARGA USB

Battery Li-ion
CLASE A



12 uds 600 LM

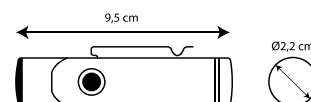

NEW PRICE!!

QUITAR SELLO BATERÍAS

LINTERNA TRABAJO BATERIA LITIO **150Lm** Micro-usb LNT-001 17,85€



Carga por Tipo-C **USB** - CABLE INCLUIDO
- BATERÍA LI-TIO
3.7V - 1200mAh

GRAN AUTONOMÍA
Batería 2000mAh
RECARGABLE CARGA USB

Battery Li-ion
CLASE A

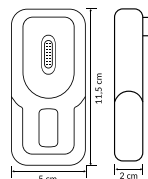

20 uds 150 LM



QUITAR SELLO BATERÍAS

LINTERNA LLAVERO MINI **BATERIA LITIO** 500mAh Usb LNT-005 8,85€

Carga por Tipo-C **USB** - CABLE INCLUIDO
- BATERÍA LI-TIO
500mAh

GRAN AUTONOMÍA
Batería 500mAh
RECARGABLE CARGA USB

Battery Li-ion
CLASE A



12 uds 300 LM

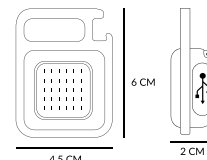

* Según la nueva normativa ERP ha habido un cambio en la medición de Lúmenes y vatios, pero sigue emitiendo la misma cantidad de luz. A medida que vayan entrando los nuevos modelos con ERP se irá actualizando en catálogo y cajas de color. Puede haber variación respecto a la caja del producto (comprobar en ficha técnica), todos los datos en catálogo están correctos salvo error tipográfico.



LINTERNA PROFESIONAL DE CABEZA



QUITAR SELLO BATERÍAS

LINTERNA CABEZA **BATERÍA LITIO 2000mAh Usb** LNT-003 11,10€

1 ud **300 LM**

Carga por **USB**

- CABLE INCLUIDO
- BATERÍA LI-TIO **5v- 18650 - 2000 mAh**



GRAN AUTONOMÍA
Batería 2000mAh
RECARGABLE CARGA USB

Battery Li-ion
CLASE A



QUITAR SELLO BATERÍAS

LINTERNA CABEZA SENSOR **BATERÍA DE LITIO 1200mAh Usb** LNT-006 20,40€

12 uds **350 LM**

Carga por Tipo-C **USB**

- CABLE INCLUIDO
- BATERÍA LI-TIO **1200mAh**



GRAN AUTONOMÍA
Batería 1200mAh
RECARGABLE CARGA USB

Battery Li-ion
CLASE A

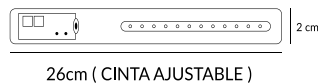



Serie Lámparas de mesa

 **INTERRUPTOR TÁCTIL**

 **GRAN AUTONOMÍA**
Batería 2600mAh
RECARGABLE CARGA USB

3 en 1 TRES TIPOS DE LUZ EN LA MISMA LUMINARIA

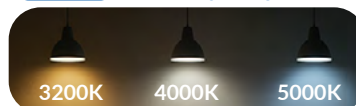

Switch **3CCT**



LÁMPARA DE MESA **BATERÍA DE LITIO DIMMABLE ALUMINIO 3CCT** Ref **LMP-001** PVPR **22,35€**



LED larga vida



Carga por USB



Batería Alta calidad



Cambio de color



3 intensidades luz



Interruptor táctil



Dimmable



LÁMPARA DE MESA **BATERÍA DE LITIO DIMMABLE BLANCO 3CCT** Ref **LMP-002** PVPR **22,35€**



LED larga vida



Carga por USB



Batería Alta calidad



Cambio de color



3 intensidades luz



Interruptor táctil



Dimmable



LÁMPARA DE MESA **BATERÍA DE LITIO DIMMABLE NEGRO 3CCT** Ref **LMP-003** PVPR **22,35€**



LED larga vida



Carga por USB



Batería Alta calidad



Cambio de color



3 intensidades luz



Interruptor táctil



Dimmable

* Según la nueva normativa ERP ha habido un cambio en la medición de Lúmenes y vatios, pero sigue emitiendo la misma cantidad de luz.

A medida que vayan entrando los nuevos modelos con ERP se irá actualizando en catálogo y cajas de color.

Puede haber variación respecto la caja del producto (comprobar en ficha técnica), todos los datos en catálogo están correctos salvo error tipográfico.



Serie Lámparas de mesa



3 en 1 TRES TIPOS DE LUZ EN LA MISMA LUMINARIA

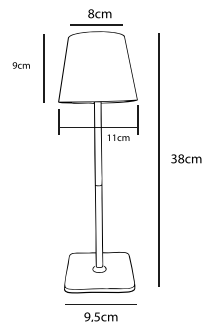
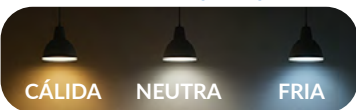

INTERRUPTOR TÁCTIL
PARTE SUPERIOR

BATERÍA
2000mAh

1 ud

110 LM

Ref PVPR

LÁMPARA DE MESA **BATERÍA DE LITIO DIMMABLE DORADA** 3CCT LMP-004 17,58€



LED larga vida



Carga por USB



Batería Alta calidad



Cambio de color



Interruptor táctil



Dimmable

4 Modos

- Modo 1: 3200K
- Modo 2: 5000K
- Modo 3: 4000K
- Modo 4: Off

2h Autonomía



INTERRUPTOR ON/OFF
PARTE TRASERA

INTERRUPTOR TÁCTIL
PARTE SUPERIOR

BATERÍA
2000mAh

1 ud

100 LM

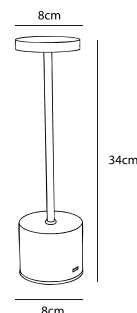

LÁMPARA DE MESA **BATERÍA DE LITIO DIMMABLE DORADA** 3CCT LMP-005 25,32€



LED larga vida



Carga por USB



Batería Alta calidad



Cambio de color



Dimmable

4 Modos

- Modo 1: 5000K
- Modo 2: Color Ambar
- Modo 3: 4000K
- Modo 4: Off

2h Autonomía



LMP-006



LMP-007

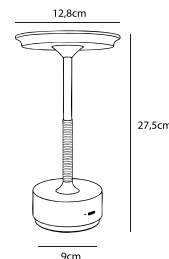

INTERRUPTOR TÁCTIL
PARTE SUPERIOR

BATERÍA
2000mAh

1 ud

160 LM

LÁMPARA DE MESA **BATERÍA DE LITIO DIMMABLE DORADA** 3CCT LMP-006 29,85€

LÁMPARA DE MESA **BATERÍA DE LITIO DIMMABLE PLATEADA** 3CCT LMP-007 29,85€



LED larga vida



Carga por USB



Batería Alta calidad



Cambio de color



Interruptor táctil



Dimmable

4 Modos

- Modo 1: 5000K
- Modo 2: 3200K
- Modo 3: 4000K
- Modo 4: Off

2h Autonomía

* Según la nueva normativa ERP ha habido un cambio en la medición de Lúmenes y vatios, pero sigue emitiendo la misma cantidad de luz.

A medida que vayan entrando los nuevos modelos con ERP se irá actualizando en catálogo y cajas de color.

Puede haber variación respecto la caja del producto (comprobar en ficha técnica), todos los datos en catálogo están correctos salvo error tipográfico.

Domotiza tu vivienda a la mejor **calidad precio** **SENCILLO Y EFICAZ**

Algunos de nuestros productos son
Compatibles con los principales asistentes de voz
(asistente de Google*, Amazon*, Alexa* ... etc.)^v

Estas marcas son propiedad de sus respectivos propietarios,
y como tal, son reconocidas por Atmoss Electric Equipment S.L
y son utilizadas únicamente con fines enunciativos.

App
tuya



HAZ TU VIDA MÁS FÁCIL Y SEGURA

DOMOTIZA TODO TU HOGAR CON PRODUCTOS DE ATMOSS

Seguridad



Cámaras



Sensores

Persianas



Pastilla interruptor de persianas.



Mando, Pulsador, interruptor de persianas

Enchufes



Interruptor wifi. Corte fase y neutro



Enchufe WiFi

Iluminación



Lámparas WiFi



Pastilla regulador Triac WiFi



Controlador Tiras de led



Proyector WiFi

Puerta garaje



Pastilla interruptor puerta de garaje.



Pulsador de persianas

Serie Domótica



La mejor forma de ampliar la cobertura WiFi en toda la casa

Sistema WiFi Mesh

ACLED-199



Cobertura en toda la casa

Hasta 1371m²



REPETIDOR **WiFi MESH**

Ref	PVPR
ACLED-199.....	311,52€



Conexiones WiFi seguras

Cifrado con seguridad inalámbrica **WPA2-PSK** de alto nivel y posibilidad de crear una **red de invitados** independiente de la red doméstica y de la información privada.



Características:

- Tecnología de conectividad: Inalámbrico
- Clase de banda de frecuencia: Doble banda
- Estándar de comunicación inalámbrica: Radiofrecuencia de 5,8 GHz, 802.11a/b/g/n, Radiofrecuencia de 2,4 GHz
- Protocolo de seguridad: WPA2-PSK
- Ancho de banda del puerto LAN: 1000Mbps
- Tasa máxima de transferencia de datos ascendente: 1000 Megabits por segundo
- Sistema Operativo: IOS, Android
- Método de control: App
- Capacidad eléctrica: M3&Dot 100 - 240 V, 50/60 Hz
- Cobertura en toda la casa: Hasta 1371m²
- Requisitos para la instalación: iOS 9.0 o posterior, dispositivo Android 4.4 o posterior y servicio de Internet
- Características básicas: SSID Broadcast | Beamforming | MU-MIMO
- Funciones avanzadas: Control parental | Red de invitados | Roaming rápido | QoS inteligente, etc.
- Tipo de conexión a Internet: PPPoE | IP dinámica | IP estática | Modo puente

Controles parentales potentes

Administra el tiempo de conexión y bloquea el contenido inapropiado en función de la edad para mantener a la familia protegida.

Puedes crear distintos perfiles de usuario y niveles de filtro para cada miembro del hogar.

Además, podrás crear una red de invitados.

BLUETOOTH Kit de sonido ambiental



ALT-003 - Amplificador

	Ref	PVPR
PACK 2 ALTAVOCES I-MASTER+I-AUXILIAR BLUETOOTH	8Oh 6,5" 25W ALT-001	177,75€
I-AUXILIAR AUXILIAR BLUETOOTH	8Oh 6,5" 25W ALT-002	45,45€
AMPLIFICADOR ALTAVOZ. (MÁX 8 ALTAVOCES)	8Oh 4 * 25W ALT-003	209,40 €

ALT-001 + ALT-002 (Instalación Máx 4 altavoces)
Si se necesita más altavoces (8máx) se conectará
ALT-003 con ALT-002
*Consultar ficha técnica



ALT-003
NO COMPATIBLE CON CAJA UNIVERSAL
✓ CAJA DE INSTALACIÓN INCLUIDA

INTERFAZ DE CONTROL:

Alimentación: 230 Vac (Rango Admitido 100-250 Vac)

Referencia: ALT-001 / 002
Tamaño altavoz: 6.5Inch
MAX Power Output: 120W
Sensibilidad: 88±3db
Impedancia: 8 Ohms
Frecuencia: 50-20KHZ
Diametro corte: 6.5Inch(16.5CM)

Bluetooth® soportado 3.0

Alcance: 8-10 m
Rango frecuencias:
2,40 GHz-2,4832 GHz (Banda ISM)

ALTAVOCES 6,5”:

Impedancia: 8 Ω
Potencia: 25 W
Material: ABS
Fijación directa a Falso techo
Dim: Ø Exterior: 190mm
Ø Corte: 165 mm

AMPLIFICADOR ALTAVOCES 8OH (MÁX 8 ALTAVOCES)

Potencia: 4*25w
Reproducción mediante:
- Tarjeta micro SD (32GB).
- Bluetooth (≤10m).
- USB (32Gb)

Compatible con formato MP3, WMA, WAV, AAC, WAW, APE, etc.

CABLE DE INSTALACIÓN:

Cable paralelo rojo/negro
Distancia máxima 30m

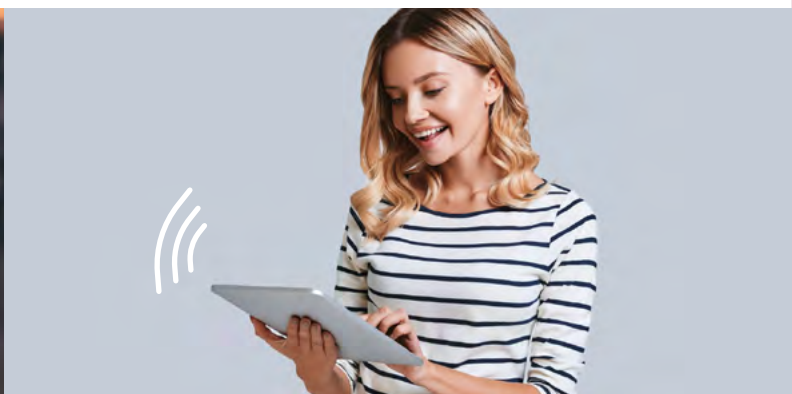
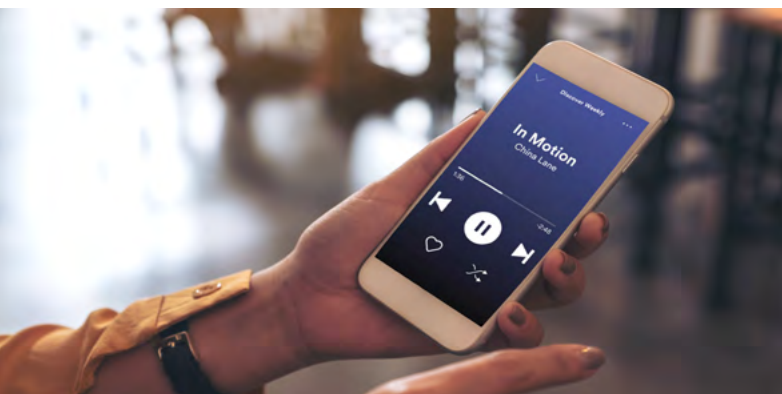

DOMÓTICA HOUSE SMART

Tuya Smart es la **aplicación más utilizada** en el sector del hogar inteligente.

Su funcionamiento está basado en la gestión de dispositivos inteligentes, proporcionando un control total y remoto, además de configurar escenarios predeterminados que aumentan la usabilidad y calidad de la APP.

SEGURIDAD

Se trata de la configuración de una red de seguridad compuesta por **alarmas, detectores, cerradura inteligente, cámaras...** Permite controlar cualquier tipo de intrusión mediante cámaras de vigilancia o alarmas personales.

PERSIANAS

Controla tu persiana mediante smartphone, mando, pulsador,...

ENCHUFES

La mejor forma de **controlar el encendido y apagado de dispositivos** conectados a la electricidad. Puede monitorizar el **ahorro de energía**, proteger contra sobretensiones, desconectar la alimentación de la red eléctrica **mediante tu smartphone**.

PUERTA GARAJE

Automatiza tu puerta del garaje, abre tu puerta sin necesidad de bajar del vehículo.

ILUMINACIÓN

Crea diferentes ambientes con nuestras lámparas WiFi. Controla el encendido o apagado, la regulación o el color desde la App.

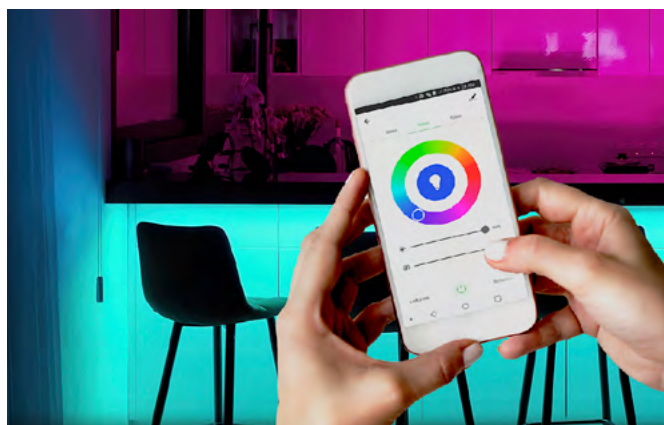

VENTAJAS

- Ayuda para personas con movilidad reducida.
- Ahorro energético.
- Mejor confort.
- Fácil instalación.
- Domotiza tu vivienda a un precio reducido.
- Amplia la cobertura WiFi en tu vivienda.



Serie Cámaras Wifi vigilancia interior

La cámara **DOMO CAM-005** cuenta con un diseño en forma de cúpula ideal para protección de espacios interiores. Ideal para pasar inadvertido, colocación en el techo con una rotación y visión panorámica.

ALTA RESOLUCIÓN 2K

COMPATIBLE CON APP **tuya**

CÁMARA DOMO WIFI VIGILANCIA 3-PRO PTZ INTERIOR

- WIFI
- COMPATIBLE CON TUYA
- SEGUIMIENTO DE OBJETOS
- 1080P
- PTZ
- VISIÓN NOCTURNA EN COLOR
- ROTACIÓN PANORÁMICA
- COMPATIBLE CON LOS PRINCIPALES ASISTENTES DE VOZ



BLANCA - VISIÓN NOCTURNA EN COLOR - ROTACIÓN PANORÁMICA

"Compatible con los principales asistentes de voz (asistente de Google*, Alexa*)"

CAMARA DOMO WIFI VIGILANCIA 3-PRO PTZ INTERIOR **2K 3.0MP** CAM-005 125,94€



Ficha técnica Video vinculación con TUYA

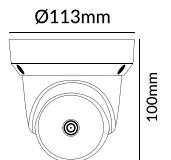

5V - 1A **tuya** CONEXIÓN USB



* Según la nueva normativa ERP ha habido un cambio en la medición de Lúmenes y vatios, pero sigue emitiendo la misma cantidad de luz. A medida que vayan entrando los nuevos modelos con ERP se irá actualizando en catálogo y cajas de color. Puede haber variación respecto a la caja del producto (comprobar en ficha técnica), todos los datos en catálogo están correctos salvo error tipográfico.



CÁMARA WIFI VIGILANCIA <i>MINI-E27 PTZ INDOOR</i>		Ref	PVPR
		CAM-008	80,40€



Ficha técnica

2.0MP
MEGAPIXEL

COMPATIBLE
CON APP **tuya**



CASQUILLO
E-27 INCLUIDO



CONEXIÓN
E27

CÁMARA CON ROSCA E-27

FACIL INSTALACIÓN



- TRANQUILIDAD ASEGURADA -

Mantén **SEGURO** tu hogar con las cámaras "Black-Eye"

- MULTIPLES INSTALACIONES -

Techo - Sobremesa - Pared



Notificaciones emergentes de señal de alarma.

Seguimiento de movimiento.

2.0MP
MEGAPIXEL

COMPATIBLE
CON APP **tuya**

SISTEMA
DOMO

CÁMARA WIFI VIGILANCIA <i>BLACK-EYE INDOOR PTZ</i>		Ref	PVPR
		CAM-007	83,16€



5V - 1A

CONEXIÓN USB

CÁMARA DE SEGURIDAD WIFI

Soporte retráctil y giratorio



DETECCIÓN DE MOVIMIENTO

Envía notificaciones al smartphone cuando detecta movimiento.

2.0MP
MEGAPIXEL

COMPATIBLE CON APP **tuya**



WIFI



2 canales audio



Sin instalación



Sensor de movimiento



PTZ



Resolucion HD



Admite tarjeta SD



Visión nocturna a color



CÁMARA WIFI MINI CUBO **VIGILANCIA INTERIOR**

Ref	PVPR
CAM-012	56,85€



* Según la nueva normativa ERP ha habido un cambio en la medición de Lúmenes y vatios, pero sigue emitiendo la misma cantidad de luz. A medida que vayan entrando los nuevos modelos con ERP se irá actualizando en catálogo y cajas de color. Puede haber variación respecto a la caja del producto (comprobar en ficha técnica), todos los datos en catálogo están correctos salvo error tipográfico.



NEW PRICE!!



SOLO ES COMPATIBLE CON LA RED 2,4G - NO CONECTAR A UNA RED 5G O DUAL POR BLOQUEO DE CÁMARA

1080P - BLANCA - VISIÓN NOCTURNA EN COLOR - Motorizada

CAMARA WIFI VIGILANCIA 2-PRO PTZ INTERIOR **IP40** CAM-004 50,25€

5V - 2A

[Ficha técnica](#)

[Video vinculación con TUYA](#)

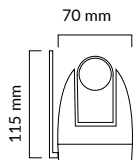

WiFi

COMPATIBLE CON APP

CONEXIÓN USB

Serie Cámaras Wifi vigilancia exterior

Exterior IP65



4.0MP
MEGAPIXEL



COMPATIBLE
CON APP **tuya**

ALTA RESOLUCIÓN

2K
QUADHD



CAM-009

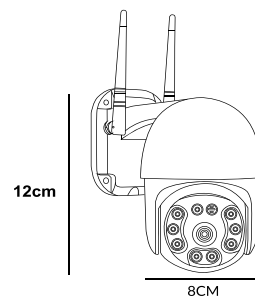

2K - BLANCA - VISIÓN NOCTURNA EN COLOR - MOTORIZADA

	Ref	PVPR
CAMARA WIFI VIGILANCIA 2K 4MP IP66	CAM-009	119,70€



* Según la nueva normativa ERP ha habido un cambio en la medición de Lúmenes y vatios, pero sigue emitiendo la misma cantidad de luz. A medida que vayan entrando los nuevos modelos con ERP se irá actualizando en catálogo y cajas de color. Puede haber variación respecto a la caja del producto (comprobar en ficha técnica), todos los datos en catálogo están correctos salvo error tipográfico.

COMPATIBLE CON APP **tuya**

CÁMARA EXTERIOR SOLAR ☀️

Conecta tu cámara sin necesidad de cableado, ni toma eléctrica

3.0MP
MEGAPIXEL

SISTEMA
4G

SISTEMA
WIFI

IP66

COMPATIBLE CON APP **tuya**

Battery
Li-ion
LiFePO4

Batería 4uds
18650 5W



La CAM-010 Cámara 4G Solar es perfecta para sitios que no hay energía eléctrica o sin Wifi. Como granjas, sitios de construcción, casas de vacaciones, almacenes, etc.

* Acepta Tarjeta SIM, (NO INCLUIDA)



	Ref	PVPR
CÁMARA SOLAR 4G 3MP PTZ EXTERIOR IP66	CAM-010	322,38€
CÁMARA SOLAR WIFI 3MP PTZ EXTERIOR IP66	CAM-011	265,68€





Serie sistemas profesional de vigilancia Exterior IP65

CÁMARAS EXTERIOR IP 65

SISTEMA POE
Conexión por cable

Cuerpo de **Aluminio**



CÁMARA TIPO BULLET

Ideal para vigilancia de aire libre y zonas de amplio rango de visión.

Debido a su diseño alargado le permite cubrir una amplia zona de visión.

- Detección de cuerpo humano
- Enfoque automático
- Grabación automática
- Aluminio
- Notificación por detección de movimiento
- Conexión por cable
- Videograbador con marcas de agua
- Compatible con los sistemas de control de voz
- Cámaras fijas

Sistema profesional de vigilancia

Visión por APP **tuya** Smartphone o ordenador



CONEXIÓN POR CABLE - Compatible con los principales sistemas de control por voz - Fijas - VIDEOGRABADOR CON MARCAS DE AGUA



SISTEMA POE 2K QUADHD 5.0MP MEGAPIXEL 1TB HDD 4CH

KIT CAMARAS SEGURIDAD	Ref	PVPR
WIFI TUYA 4CH 2K 1TB + HDD	SGR-029	836,55€

230v 1 SISTEMA POE IP 65 tuya



SISTEMA POE 2K QUADHD 5.0MP MEGAPIXEL 2TB HDD 8CH

KIT CAMARAS SEGURIDAD	Ref	PVPR
WIFI TUYA 8CH 2K 2TB + HDD	SGR-030	1553,58€

230v 1 SISTEMA POE IP 65 tuya

* Según la nueva normativa ERP ha habido un cambio en la medición de Lúmenes y vatios, pero sigue emitiendo la misma cantidad de luz. A medida que vayan entrando los nuevos modelos con ERP se irá actualizando en catálogo y cajas de color. Puede haber variación respecto a la caja del producto (comprobar en ficha técnica), todos los datos en catálogo están correctos salvo error tipográfico.



CÁMARAS EXTERIOR

IP 65



SISTEMA POE



Conexión por cable

- Detección de cuerpo humano
- Enfoque automático
- Grabación automática
- Aluminio
- Notificación por detección de movimiento
- Conexión por cable
- Videograbador con marcas de agua
- Compatible con los sistemas de control de voz
- Cámaras con movimiento PTZ 355° y 90°
- Bidireccional



Sistema profesional de vigilancia

Visión por APP **tuya** Smartphone o ordenador



CONEXIÓN POR CABLE - Compatible con los principales sistemas de control por voz - PTZ - VIDEOGRABADOR CON MARCAS DE AGUA



KIT CAMARAS SEGURIDAD	Ref	PVPR
WIFI TUYA 4CH 2K 1TB + HDD	SGR-032	855,42€



KIT CAMARAS SEGURIDAD	Ref	PVPR
WIFI TUYA 8CH 2K 2TB + HDD	SGR-033	1440,36€





CÁMARAS EXTERIOR IP 65

VISIÓN NOCTURNA A COLOR

SISTEMA WIFI

SE ENCIENDE EL FLASH AL DETECTAR MOVIMIENTO

SEÑAL WIFI NO AMPLIFICABLE

- Hasta 450 m de distancia de transmisión sin barreras.
- 30 m a través de paredes.
- * (Sujeto a variaciones según condiciones de instalación)

Sistema profesional de vigilancia

Visión por APP **tuya** Smartphone o ordenador

CONEXIÓN WIFI - Compatible con los principales sistemas de control por voz - PTZ - VIDEOGRABADOR CON MARCAS DE AGUA



KIT CAMARAS SEGURIDAD	Ref	PVPR
WIFI TUYA 8CH 2K 2TB + HDD	SGR-031	874,29€

CAMARAS CON VIDEOGRABADOR

IP65



CONEXIÓN POR CABLE - Compatible con los principales sistemas de control por voz - Fijas VIDEOGRABADOR CON MARCAS DE AGUA

KIT CAMARAS SEGURIDAD	Ref	PVPR
CABLE RED 4CH 1080P POE 1TB HDD	SGR-007	358,50€

Contenido de la caja:

- 1 Grabador NVR con HDD
- 4 Cable red 2x18,5m-2x30,5m
- 1 Ratón USB
- 1 Adaptador 52V 2A Grabador
- 4 Cámaras IP
- 1 Manual de usuario
- 4 Llave Allen para cámaras
- 4 Bolsa tornillos (para cámaras)

* Según la nueva normativa ERP ha habido un cambio en la medición de Lúmenes y vatios, pero sigue emitiendo la misma cantidad de luz. A medida que vayan entrando los nuevos modelos con ERP se irá actualizando en catálogo y cajas de color. Puede haber variación respecto a la caja del producto (comprobar en ficha técnica), todos los datos en catálogo están correctos salvo error tipográfico.

Serie Iluminación domótica

APP CONTROL REMOTO

COMPATIBLE CON APP **tuya**

Iluminación



Administre su iluminación desde cualquier lugar con WiFi



	°K	Ref	PVPR
Miniesférica Led WiFi REGULABLE	G45 E14 5W 470Lm	BLED-221	21,51€
Miniesférica Led WiFi REGULABLE	G45 E27 5W 470Lm	BLED-220	21,51€



tuya

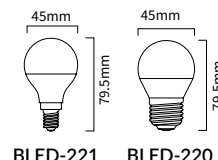

Standar Led WiFi REGULABLE	A60 E27 10W 900Lm	BLED-219	21,51€
----------------------------	-------------------	----------	--------



tuya

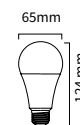

Dicroica Led WiFi REGULABLE	GU10 5W 400Lm	DIC-090	21,51€
-----------------------------	---------------	---------	--------



tuya

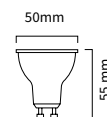

Globo Led WiFi REGULABLE	G95 E27 11W 1055Lm	BLED-222	28,71€
--------------------------	--------------------	----------	--------

Globo Led WiFi REGULABLE	G120 E27 15W 1520Lm	BLED-223	32,31€
--------------------------	---------------------	----------	--------



tuya

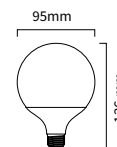

INCLUYE MANDO

INCLUYE MANDO - REGULABLE - CARRIL TRIFÁSICO

	°K	Ref	PVPR
TRACK LIGHT LED INTEGRADO 3CCT	WiFi 30W Blanco 3CCT	TRCK-056	125,94€
TRACK LIGHT LED INTEGRADO 3CCT	WiFi 30W Negro 3CCT	TRCK-057	125,94€



tuya

TRCK-058 LENTE INTERCAMBIABLE 60°

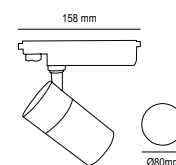



INCLUYE MANDO

* Compatible con TUYA

PROYECTOR DOWNLIGHT RECTANGULAR BLANCO **WIFI - 40w** 3CCT PRY-138 142,56€

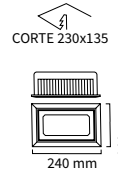

INCLUYE MANDO

* Compatible con TUYA - Mando incluido RF - REGULABLE

PANEL LED 60 X 60CM **WIFI 40W - ARO BLANCO** 3CCT + RGB DOW-318 208,92€

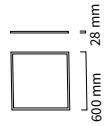

COMPATIBLE CON TUYA - INCLUYE MANDO RF - CON MEMORIA

Para el funcionamiento del mando a distancia es necesario vincular primero el proyector a su conexión wifi.



INCLUYE MANDO

PROYECTOR EXTERIOR WIFI **10W - 750Lm - IP65** RGB 3CCT PRY-104 62,73€

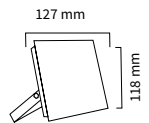

PROYECTOR EXTERIOR WIFI **20W - 1600Lm - IP65** RGB 3CCT PRY-105 66,18€

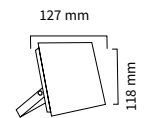

Combina los colores como quieras con el modo RGB.

O cambia de tono entre 3200K hasta 5000K con el modo 3CCT.

Desde un tono cálido, pasando por un blanco hasta un tono frío.



3 en 1 TRES TIPOS DE LUZ EN LA MISMA LUMINARIA

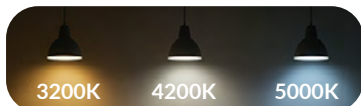

Switch 3CCT

* Según la nueva normativa ERP ha habido un cambio en la medición de Lúmenes y vatios, pero sigue emitiendo la misma cantidad de luz. A medida que vayan entrando los nuevos modelos con ERP se irá actualizando en catálogo y cajas de color. Puede haber variación respecto la caja del producto (comprobar en ficha técnica), todos los datos en catálogo están correctos salvo error tipográfico.

App
tuya

Serie pastillas de iluminación domótica

Compatible con los principales sistemas de control por voz



Para interruptor simple, conmutado y cruce



PASTILLA INTERRUPTOR MINI LED

WIFI 300W LED

Ref

PVPR

CONTR-054

41,91€



tuya

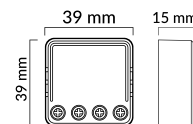

Pastilla MINI
39x39x15mm



No apta para instalaciones conmutables

PASTILLA INTERRUPTOR MINI MULTIFUNCIÓN

WIFI 300W LED

CONTR-082

29,85€



tuya

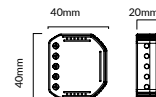

Para DOBLE interruptor e interruptor partido

PASTILLA DOBLE INTERRUPTOR LED

WIFI 2 X 150W

CONTR-042

56,31€



tuya

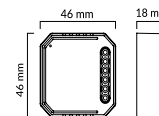

Disponible
para varios
pulsadores



PASTILLA DIMMABLE TRIAC WIFI 300W LED

WIFI 300W LED

CONTR-063

60,66€



tuya

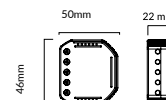

PASTILLA TELERRUPTOR MINI WIFI

16A 230V - 300W LED

CONTR-071

45,06€



tuya

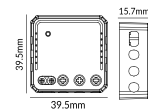

NEW!



CONTROLADOR DIMMABLE TRIAC WIFI PULSADOR

WIFI 500W LED

CONTR-096

84,30€



tuya



- CONEXIÓN WIFI, 2,4Ghz, BLUETOOTH
- CONTROL REMOTO 2,4Ghz
- DIMMABLE 0-100% SIN PARPADEO

NEW!



Compatible con CONTR-105 - NO INCLUIDO

	Ref	PVPR
PASTILLA DIMMABLE TRIAC WIFI RF UART HOLE 200W	CONTR-104	58,50€



tuya



Accesorio control remoto pulsador dimmable

CONTR-105	14,43€
-----------	--------

NEW!



NO DISPONE DE WIFI

PASTILLA INTERRUPTOR ON/OFF C/CONTROL REMOTO EXTERIOR	CONTR-127	25,68€
---	-----------	--------



Control remoto incluido

NEW!



NO DISPONE DE WIFI

REGULADOR DIMMER C/CONTROL REMOTO	CONTR-126	25,68€
-----------------------------------	-----------	--------



Control remoto incluido

NEW!



NO DISPONE DE WIFI

PASTILLA INTERRUPTOR DIMMER C/CONTROL REMOTO	CONTR-125	35,40€
--	-----------	--------



Control remoto incluido



NO DISPONE DE WIFI

	Ref	PVPR
PASTILLA REGULACIÓN LED SIN NEUTRO MÁX 250W	CONTR-083	55,02 €

REGULACIÓN TRIAC



Este dimmer LED está diseñado para el control de lámparas LED regulables de hasta 250W. Con características de diseño compacto, brillo ajustable, potencia y memoria de ajuste de luz, es fácil de instalar y operar.

- Tamaño compacto
- Sin ruido
- Regulación del borde de salida
- No necesita línea neutra
- Ideal para reequipamiento
- Luminosidad y velocidad de regulación regulables
- Memoria de potencia y luminosidad

- REGULACIÓN TRIAC
- NO APTA PARA INSTALACIONES CONMUTADAS
- SE PUEDE USAR CON PULSADORES EN PARALELO

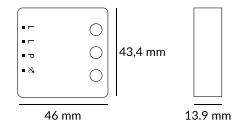

NO DISPONE DE WIFI

PASTILLA PULSADOR CON EFECTO MEMORIA - FUNCIONA PARA VARIOS PULSADORES -

PASTILLA DIMMABLE TRIAC POR PULSADOR	CONTR-022	52,62€
---	-----------	--------



COMPATIBLE CON MANDO CONTR-036 Y CONTR-098

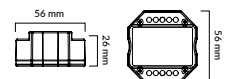

CONTR-036 CONTR-098

Serie controlador tiras led domótica

App
tuya

Convierte y controla tu instalación de tiras LED en WiFi



Hasta 5 canales (5 en 1), diferentes colores, con un mismo controlador en un mismo lugar.

COMPATIBLE
CON APP **tuya**

Función 5 en 1 solo en CONTR-108, 109, 061, 062

• Para tiras Monocolor



PARA TIRAS MONOCOLOR

Compatible con CONTR-107 - NO INCLUIDO

PUSH + RF

* FUNCIONA CON MANDO, y APP Tuya

PASTILLA REGULACIÓN TIRA LED MONO **WIFI 10A - 240W** Ref: CONTR-106 PVPR: 70,20€



tuya



Máx: 10A - 2.4GHz

* COMPATIBLE CON MANDO **CONTR-107** 48,60€

* COMPATIBLE CON APP TUYA SMART LIFE.



• Para tiras 3CCT y Monocolor



Ref

PVPR

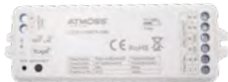

PARA TIRAS 3CCT y MONOCOLOR

* FUNCIONA CON PULSADOR y APP Tuya

CONTROLADOR TIRA LED 3CCT **WIFI** Ref: CONTR-060 PVPR: 75,87€



tuya



Máx: 10.5A - 5A/CH - 2 canales - 2.4GHz

* COMPATIBLE CON APP TUYA SMART LIFE.



PARA TIRAS 3CCT y MONOCOLOR

* FUNCIONA CON PULSADOR, Mando, y APP Tuya

CONTROLADOR TIRA LED 2 EN 1 DIM PUSH **WIFI** Ref: CONTR-095 PVPR: 86,40€



tuya



Máx: 30A - 30A/CH - 2.4GHz

* COMPATIBLE CON APP TUYA SMART LIFE.

* COMPATIBLE CON MANDO **CONTR-030**



PARA TIRAS 3CCT y MONOCOLOR

* Funciona con Mando, y APP Tuya

CONTROLADOR WIFI 3CCT 15A **WIFI** Ref: CONTR-130 PVPR: 40,20€



tuya



Máx: 15A - 6A/CH - 2.4GHz

* COMPATIBLE CON APP TUYA SMART LIFE.

* COMPATIBLE CON MANDO **CONTR-129**



Para tiras **RGB** y **3CCT** **FUNCIÓN 5 EN 1**



PARA TIRAS **3CCT, RGB+W y 3CCT+RGB**

* FUNCIONA CON PULSADOR, Mando, y APP Tuya

CONTROLADOR TIRA LED 5 EN 1 **WIFI** CONTR-108 63,75€



tuya



Máx: 20A - 15A/CH - 5 canales - 2.4GHz
* COMPATIBLE CON APP TUYA SMART LIFE.
* COMPATIBLE CON MANDO CONTR-110



PARA TIRAS **3CCT, RGB+W y 3CCT+RGB**

* FUNCIONA CON PULSADOR, Mando, y APP Tuya

CONTROLADOR MINI TIRA LED 5 EN 1 **WIFI** CONTR-109 59,85€



tuya



Máx: 10A - 6A/CH - 5 canales - 2.4GHz
* COMPATIBLE CON APP TUYA SMART LIFE.
* COMPATIBLE CON MANDO CONTR-110



PARA TIRAS **3CCT, RGB+W y 3CCT+RGB**

* FUNCIONA CON APP Tuya

CONTROLADOR TIRA LED 5 EN 1 **WIFI** CONTR-061 75,87€



tuya

Máx: 15A - 3A/CH - 5 canales - 2.4GHz
* COMPATIBLE CON APP TUYA SMART LIFE.

CONTROLADOR TIRA LED 5 EN 1 **WIFI - BLUETOOTH** CONTR-062 70,98€

Para tiras **Digitales**



Válido para TLED-135-170-171

Ref

PVPR

CONTROLADOR LED 8A **RGB/RGBW DIGITAL SPI** CONTR-100 73,32€



tuya



INSTRUCCIONES



VIDEO INSTALACIÓN

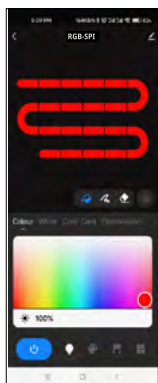

Color

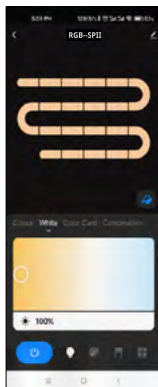

Blanco

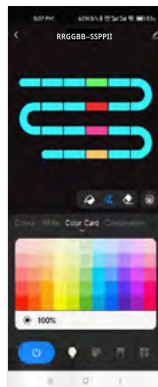

Carta de colores

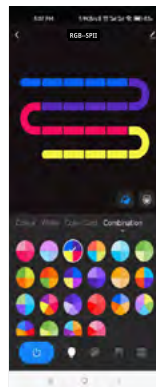

Combinación

Personaliza completamente una gran cantidad de modos de color RGB / RGBW



Ritmo musical



Escenas



Mezcla de colores por segmentos



Temporizador



Control por voz



Control por APP



16 millones de colores



Ajuste de brillo

* Según la nueva normativa ERP ha habido un cambio en la medición de Lúmenes y vatios, pero sigue emitiendo la misma cantidad de luz. A medida que vayan entrando los nuevos modelos con ERP se irá actualizando en catálogo y cajas de color. Puede haber variación respecto a la caja del producto (comprobar en ficha técnica), todos los datos en catálogo están correctos salvo error tipográfico.



Serie sistemas



3200 Kelvin

5000 Kelvin

• Eficiencia, precisión y flexibilidad

Sistema de control **DALI**:

DALI (Digital Addressable Lighting Interface) es un sistema de control digital estandarizado diseñado para gestionar de forma inteligente instalaciones de iluminación. Permite el encendido, apagado y regulación de luminarias individuales o en grupos, facilitando un control preciso, eficiente y personalizado en todo tipo de espacios.

Gracias a su estructura descentralizada y su comunicación bidireccional, DALI simplifica la instalación, mejora el mantenimiento y ofrece una gran flexibilidad a la hora de crear escenas o integrar sensores de presencia y luz natural.

Ideal para oficinas, centros comerciales, hoteles o edificios públicos, el sistema DALI se ha consolidado como una solución robusta y escalable para proyectos de iluminación profesional.

• Una luz inteligente ahorra energía

Una de las funciones principales de DALI es la regulación progresiva de lámparas LED. La adaptación de la luminosidad a las necesidades reales de los usuarios evita el consumo innecesario de energía.

Serie sistemas

Este tipo de sistema se puede aplicar en diversos entornos donde se requiere un control preciso y eficiente de la iluminación.

Por ejemplo:

Edificios comerciales, oficinas, colegios, centros de salud, naves, aeropuertos,...



Control remoto mediante mando RF o aplicación Tuya

Función 6 en 1 - Temperatura de color, RGB, RGBW, RGB+CCT

Ref PVPR

CONVERTIDOR WIFI/RF A DALI	CONTR-113	22,60€
----------------------------	-----------	--------



Compatible con CONTR-113

CONTROL REMOTO 8 ESCENAS 8 ZONAS

CONTR-114 70,47€



Funciona con pulsador

REGULADOR DE INTENSIDAD TRIAC - DALI

CONTR-115 55,56€



Funciona con pulsador

REGULADOR DE INTENSIDAD PULSABLE DALI

CONTR-116 74,70€



* Según la nueva normativa ERP ha habido un cambio en la medición de Lúmenes y vatios, pero sigue emitiendo la misma cantidad de luz. A medida que vayan entrando los nuevos modelos con ERP se irá actualizando en catálogo y cajas de color. Puede haber variación respecto a la caja del producto (comprobar en ficha técnica), todos los datos en catálogo están correctos salvo error tipográfico.



Pastillas para persiana



Válido para motores de 2 fases, 1 neutro y tierra

PASTILLA INTERRUPTOR DE PERSIANAS

WIFI + RF433

CONTR-068

49,80€



tuya

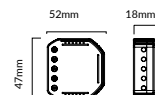

MANDO PARA PASTILLA CONTR-068

1 PERSIANA

CONTR-069 18,84€

MANDO PARA PASTILLA CONTR-068

HASTA 9 PERSIANAS

CONTR-070 35,70€



Válido para motores de 2 fases, 1 neutro y tierra

PASTILLA INTERRUPTOR DE PERSIANAS

WIFI

CONTR-045

54,00€



tuya

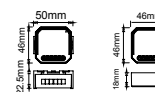

Válido para motores de 2 fases, 1 neutro y tierra

Con control remoto

PASTILLA INTERRUPTOR DE PERSIANAS

CONTR-124

38,19€



Pastilla medidor solar



PASTILLA MEDIDOR SOLAR ALTA PRECISIÓN 2 CANALES

WIFI

CONTR-123

59,70€



tuya



Pastillas para puerta de garaje



Incluido finales de carrera

PASTILLA INTERRUPTOR PUERTA GARAGE

WIFI

Ref PVPR
CONTR-053 79,08€



tuya

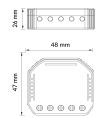

Incluido finales de carrera

PASTILLA INTERRUPTOR PUERTA GARAGE

WIFI

Ref PVPR
CONTR-111 87,48€



tuya

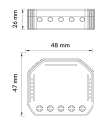

Máximo hasta 100uds

Accesorio control remoto push
CONTR-107

Ref PVPR
CONTR-112 10,20€

Pastilla para cerradura electrónica



Compatible con CONTR-118 - NO INCLUIDO

PASTILLA ON/OFF WIFI RF UART HOLE

250W

Ref PVPR
CONTR-117 31,50€



tuya

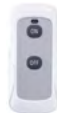

Mando control remoto ON/OFF



Ref PVPR
CONTR-118 13,62€



CONTACTO SECO

PASTILLA INT WIFI CONTACTO SECO I CH

150W

Ref PVPR
CONTR-122 32,40€



Serie enchufe inteligente

- Compatible con los principales sistemas de control por voz
- Te permite programar múltiples encendidos.
- Control de consumo energético (instantáneo, mensual y anual)



NEW!



	Control remoto ON/OFF	No dispone de wifi	Ref	PVPR
ENCHUFE INTERIOR CONTROL REMOTO ON/OFF	10A		ACLED-307	25,35€



NEW!



	Control remoto ON/OFF	No dispone de wifi	Ref	PVPR
ENCHUFE INTERIOR CONTROL REMOTO 1-3RECEPTOR	16A		ACLED-308	22,44€



ENCHUFE INTELIGENTE SMART CON LUZ	10A	WIFI	ACLED-092	43,17€
-----------------------------------	-----	------	-----------	--------



tuya

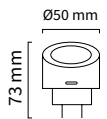

ENCHUFE INTELIGENTE SMART	16A	WIFI	ACLED-121	28,56€
---------------------------	-----	------	-----------	--------



tuya

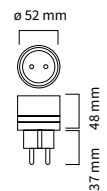

NEW!



IP44

ENCHUFE INTELIGENTE SMART EXTERIOR	16A	WIFI	ACLED-306	27,51€
------------------------------------	-----	------	-----------	--------



tuya



ENCHUFE INTELIGENTE SMART DOBLE BLANCO	2x16A	WIFI	ACLED-133	53,85€
--	-------	------	-----------	--------



tuya

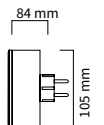

Carga rápida USB

REGLETA INTELIGENTE SMART	10A x 3 tomas + 4usb x 2A	WIFI	ACLED-110	72,06€
---------------------------	---------------------------	------	-----------	--------



tuya

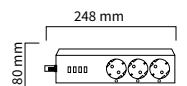



Con el interruptor inteligente puedes **apagar y encender cualquier dispositivo**, desde lámparas hasta televisiones, aire acondicionado, estufas, calderas, etc ... Soporta hasta 16A de carga máxima.

El interruptor inteligente se conecta a la WiFi de su domicilio, y con la app Tuya (gratuita para Android e iOS) instalada en tu teléfono móvil puedes controlar desde cualquier sitio si quieres encender o apagar el dispositivo que tengas conectado. Es compatible con redes WiFi.

El interruptor inteligente se conecta a la red eléctrica mediante un bloque terminal de entrada, y tiene otro bloque terminal de salida.

Moderniza tu casa o tu negocio de la forma más fácil y económica.



Corte de fase y neutro programable

INTERRUPTOR WIFI PROGRAMABLE	2200W max	10Ah max	CONTR-048	21,51€
	↓		tuya	



Corte de fase y neutro programable

INTERRUPTOR WIFI PROGRAMABLE	3520W max	16Ah max	CONTR-451	34,92€
	↓		tuya	



Corte de fase y neutro programable

INTERRUPTOR WIFI PROGRAMABLE	6600W max	30Ah max	CONTR-452	36,42€
	↓		tuya	

* Según la nueva normativa ERP ha habido un cambio en la medición de Lúmenes y vatios, pero sigue emitiendo la misma cantidad de luz. A medida que vayan entrando los nuevos modelos con ERP se irá actualizando en catálogo y cajas de color. Puede haber variación respecto la caja del producto (comprobar en ficha técnica), todos los datos en catálogo están correctos salvo error tipográfico.

Controla tu hogar desde 1 SOLO PUNTO



— Tecnología —
zigbee

Bajo consumo
Haciendo que las baterías de los productos domóticos duren mucho más.

- Funciona con nuestros módulos WiFi
- Alimentación por batería



CR2430
CR2430 3V
Batería no incluida

1Año
1 Año autonomía

1.3cm
espesor
Fácil de transportar

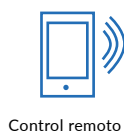
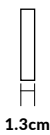

Control remoto



Ajustes escenas
12 escenas



Botón mecánico



Uso interior

INTERRUPTOR INTELIGENTE 12 ESCENAS



Ref: **CONTR-093**
PVPR: **81,96€**

COMPATIBLE CON APP **tuya**

FÁCIL INSTALACIÓN
Montaje en superficie con adhesivo

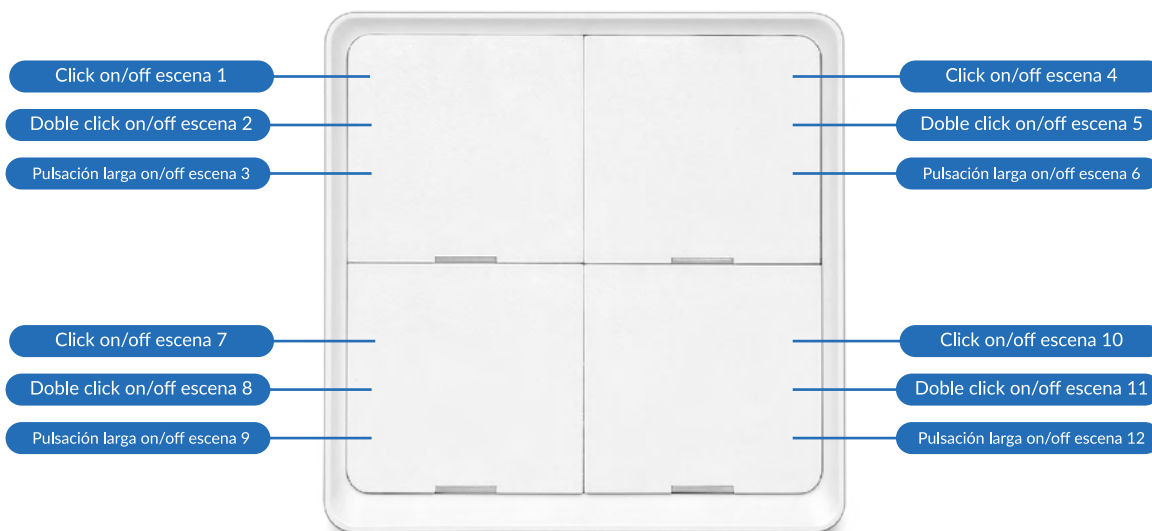

1 Interruptor
12 ESCENAS 4 AMBIENTES

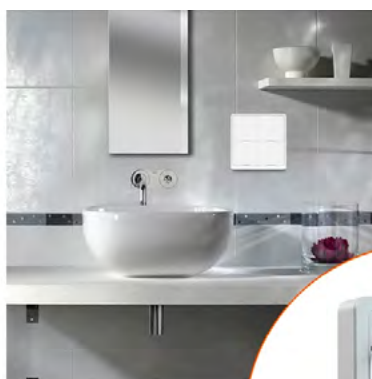

Aseo



Cocina

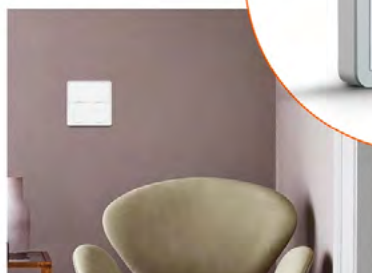

Sala de estar



Dormitorio

Cada botón tiene **3 modos de vinculación**
12 escenas



4 botones
pueden ser
individuales



3 métodos
de presión



Elegir dispositivos
inteligentes de
vinculación o control

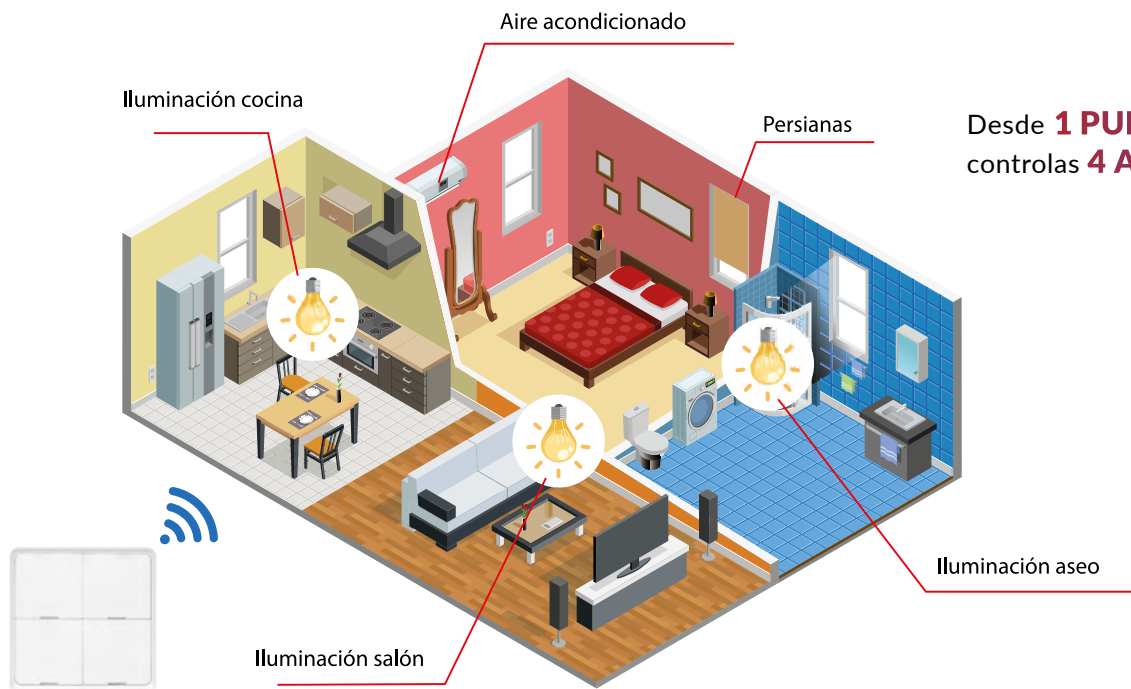

Desde **1 PUNTO**
controlas **4 AMBIENTES**

Puerta de enlace Gateway

Control hasta
128 dispositivos

La puerta de enlace multimodo admite comunicación multiprotocolo Wi-Fi+Bluetooth+Zigbee. La malla Bluetooth (SIG) y la comunicación Zigbee garantizan un control estable de 128 dispositivos. La puerta de enlace implementa la comunicación entre la nube y los teléfonos móviles a través de Wi-Fi. Los dispositivos Zigbee y Bluetooth mesh (SIG) conectados se pueden ver y controlar de forma remota mediante la aplicación.

Además, los usuarios pueden implementar las funciones de agregar y restablecer dispositivos, control de terceros y control de grupos de subdispositivos. Esas características pueden cumplir con los requisitos de escenarios diversificados de hogares inteligentes



PUERTA DE ENLACE GATEWAY



Ref PVPR
CONTR-094 64,23€

Interruptor *inalámbrico*

Añade un interruptor fácilmente donde quieras SIN NECESIDAD DE CABLEADO

Kit 2 Interruptores RF Switch + pastilla WiFi



Interruptor RF sin cableado



Sin pilas o batería



Protección del medio ambiente



Ahorro de energía



Fácil instalación



Pastilla con memoria



Se puede añadir varios interruptores

TECNOLOGÍA **KINETIC**



• **Múltiples interruptores sin acoplarse.**

• **Controla el encendido apagado a distancia ON/OFF**

Programa horarios



APLICACIONES



Jardín

La solución minimalista para la iluminación del jardín.

Exterior

Controla la iluminación sin necesidad de moverte.



Sin contacto

Aplicación del interruptor sin contacto para hospitales.

Aseos

Añade interruptor en tu aseo, sin quitar o cambiar azulejos.
Sin necesidad de obras

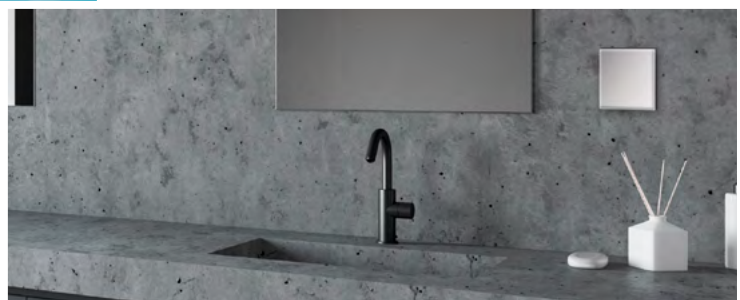

PASTILLA WIFI y 2 INTERRUPTORES INALÁMBRICOS RF 16A CONTR-081 70,32€



tuya

16A



NO NECESITA PILAS O BATERÍA



FÁCIL INSTALACIÓN
Montaje en superficie con adhesivo

Interruptor x2

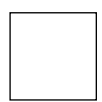

85mm

Pastilla

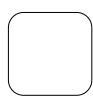

48 mm

22 mm

- **Simplicidad y comodidad** con un solo clic.
- **Pastilla codificada.** Posibilidad de instalar varias instalaciones sin acoplarse.
- **Compatible** con los principales sistemas de **control por voz.**



ESCANEA PARA
DESCARGAR
FICHA TÉCNICA

Serie aire acondicionado



CONTROL PROGRAMABLE SEMANAL

APAGADO CON MEMORIA

MODO MÚLTIPLES MODOS DE TRABAJO

VINCULACIÓN RÁPIDA Y SENCILLA

2 pilas AAA - linterna piloto led

Ref PVPR

MANDO UNIVERSAL AIRE ACONDICIONADO PROGRAMABLE 1000 CÓDIGOS CONTR-084 20,70€



1000 CÓDIGOS **EN 1** MAYOR COMPATIBILIDAD

99% Compatible con el 99% de las marcas



CONTR-090

Control remoto aire acondicionado

Controla el aire acondicionado de forma remota desde tu smartphone APP

CONTROL REMOTO WIFI Aire Acondicionado Con pantalla **WIFI** CONTR-090 94,35€



4 Modos velocidad



5 Modos temperatura



Modo ECO



Historial de temp



Programar horario



Modo comfortable



Aviso cambio filtro de aire

tuya



CONTR-091

CONTROL REMOTO WIFI Aire Acondicionado **WIFI** CONTR-091 59,55€



4 Modos velocidad



5 Modos temperatura



Modo ECO



Historial de temp



Programar horario



Modo comfortable



Aviso cambio filtro de aire

tuya

Controla la

- Temperatura
- On/Off
- Programa horarios
- Historial de temp

Control remoto Wi-Fi

Controla a distancia desde tu smartphone cualquier electrodoméstico

COMPATIBLE CON APP **tuya**

Sistema IR

Control remoto WiFi



CONTROL REMOTO WIFI IR + RF **WIFI** Ref: CONTR-085 PVPR: 44,85€

- 210° ROTACION: Rotación 210°
- Control por APP
- Control por voz
- USB
- Link
- Escena personalizada



CONTROL REMOTO WIFI IR + RF con cable USB **WIFI** Ref: CONTR-086 PVPR: 46,35€

CONTROL REMOTO WIFI IR + RF cable USB y pantalla TEMP/HUM **WIFI** Ref: CONTR-087 PVPR: 39,90€



Control remoto con SENSOR TEMPERATURA / HUMEDAD



CONTR-088

CONTROL REMOTO WIFI IR **WIFI** Ref: CONTR-088 PVPR: 55,14€

- Sensor de temp
- Sensor de humedad
- Control por voz



CONTR-089

CONTROL REMOTO PRO WIFI IR **WIFI** Ref: CONTR-089 PVPR: 86,70€

- Sensor de temp
- Sensor de humedad
- Control por voz
- Botón táctil
- Modo IR



Especial para Aire acondicionado y Televisores



CONVERTIDOR WIFI A IR **7-10mts 300mA 2.4Ghz 360°** Ref: CONTR-047 PVPR: 35,94€

- 24v
- 1
- WIFI
- IR

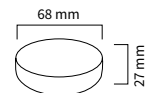

2,4/5,8 GHz - 1200Mbps
3 modos de uso: Repetidor, router, modo AP

REPETIDOR WIFI DOBLE BANDA Ref: ACLED-161 PVPR: 130,17€

- 24v
- 1
- WIFI



MEDIDAS: 172x75x52mm
GIRO ANTENAS: 180°

* Según la nueva normativa ERP ha habido un cambio en la medición de Lúmenes y vatios, pero sigue emitiendo la misma cantidad de luz. A medida que vayan entrando los nuevos modelos con ERP se irá actualizando en catálogo y cajas de color. Puede haber variación respecto a la caja del producto (comprobar en ficha técnica), todos los datos en catálogo están correctos salvo error tipográfico.

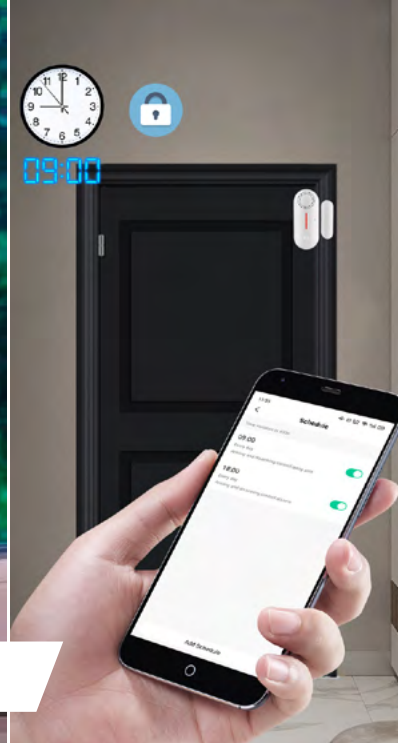

Serie sensores domóticos

Al detectar que se abre la puerta o la ventana se dispara la alarma

Programar temporizador para Activar/Desactivar la conexión

SENSORES domóticos

Protege tu vivienda de la manera más **RÁPIDA** y **FÁCIL DE CONECTAR**.

Envío de notificaciones al smartphone



Compatible con **tuya**

SENSORES PUERTA



Pilas AAA (2*1.5V) No incluidas

Ref

PVPR

ALARMA SEGURIDAD SENSOR PUERTA **CON SONIDO**

WiFi

SGR-018

40,44€



tuya



100dB



Pilas AAA (2*1.5V) No incluidas

ALARMA SEGURIDAD SENSOR PUERTA **SIN SONIDO**

WiFi

SGR-012

31,20€



tuya





BOTÓN SOS



No dispone de WiFi

BOTÓN SOS CON TIMBRE

SGR-046 20,94€



Batería
3.7v / 400mAh



USB TIPO C

COMBINACIONES



Envío de notificaciones al smartphone



Compatible con **tuya**



BOTÓN WIFI SOS TUYA

SGR-038 47,16€



Batería
3.7v / 400mAh



USB TIPO C

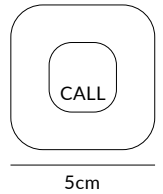



Detecta y envía notificaciones de posibles fugas de agua y cierra la válvula de agua de forma remota.

SENSOR AGUA



		Ref	PVPR
ALARMA SEGURIDAD SENSOR FUGAS DE AGUA	WiFi	SGR-013	32,40€



- MONTAJE COLGADO EN PARED
- CON ADHESIVO O TORNILLOS (INCLUIDO)
- AAA PILAS (INCLUIDAS)



tuya

Pilas AAA (2*1.5V) Incluidas



ALARMA SEGURIDAD SENSOR FUGAS DE AGUA	WiFi	SGR-020	30,75€
---------------------------------------	------	---------	--------



- MONTAJE COLGADO EN PARED
- CON ADHESIVOS (INCLUIDO)
- AAA PILAS (NO INCLUIDAS)



tuya

Pilas AAA (2*1.5V) No Incluidas



ALARMA SEGURIDAD SENSOR FUGAS DE AGUA SUELO	WiFi	SGR-019	42,60€
---	------	---------	--------



- MONTAJE EN EL SUELO



tuya

Pilas DC3V CR123A (Incluida)

· Cierra la válvula de agua de forma remota



CIERRE VALVULA WIFI	WiFi	SGR-023	71,10€
---------------------	------	---------	--------



- Tiempo de cierre y apertura de la válvula 5-10 seg
- Válvula de palanca



tuya

- Tamaño Válvula:
- 1" pulgada (DN25)
 - 1.25" pulgada (DN32)

Alimentación mediante transformador 230V/12V (Incluido)



ALARMA SENSOR PIR ((🚶))



Alimentación USB DC5V (Incluida)

ALARMA SEGURIDAD SENSOR PIR

WiFi

Ref

SGR-014

PVPR

41,70€



tuya

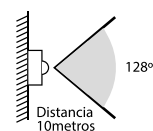

Alimentación USB DC5V (Incluida)

ALARMA SEGURIDAD SENSOR PIR CON SONIDO ALARMA

WiFi

SGR-025

56,25€



tuya

100dB

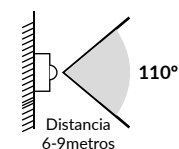

Pila 1 ud - CR17335/CR123A DC5V (Incluida)

SENSOR DE MOVIMIENTO INTERIOR PORTATIL 3V

WiFi

SGR-026

68,10€



tuya

LED AZUL SEÑAL DE ALARMA

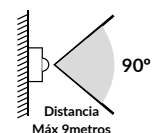

Detección de movimiento SOLAR

Larga duración



Posibilidad de cargar con USB



SENSOR DE MOVIMIENTO SOLAR CON SONIDO ALARMA

WiFi

SGR-022

59,85€



CARGA SOLAR O USB



tuya

SOLAR

120dB

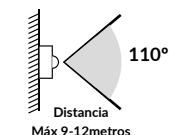

Control remoto por mando a distancia

· DETECCIÓN
12 Metros
120° Ángulo

· ALARMA 120dB

· DURACIÓN 20 seg



* Según la nueva normativa ERP ha habido un cambio en la medición de Lúmenes y vatios, pero sigue emitiendo la misma cantidad de luz.

A medida que vayan entrando los nuevos modelos con ERP se irá actualizando en catálogo y cajas de color.

Puede haber variación respecto a la caja del producto (comprobar en ficha técnica), todos los datos en catálogo están correctos salvo error tipográfico.

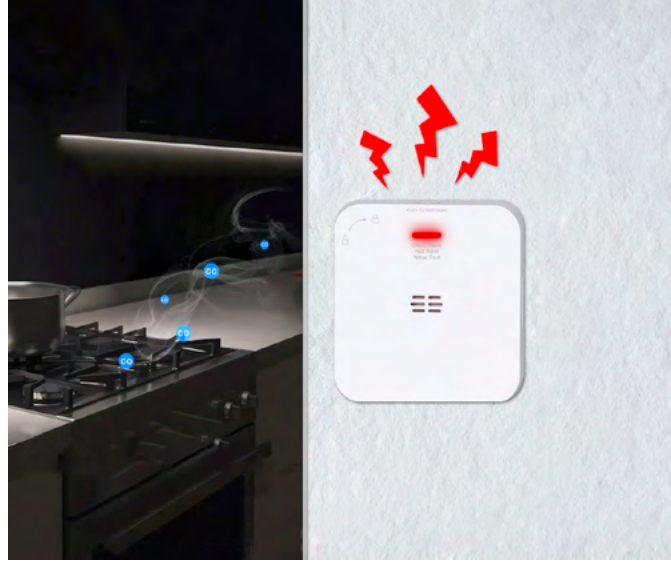

SENSOR GAS



CON SONIDO ALARMA

ALARMA SEGURIDAD SENSOR GAS NATURAL / METANO / BIOGAS

Ref **PVPR**
WiFi SGR-021 65,58€



- DETECCIÓN DE GAS NATURAL / METANO / BIOGAS

80dB



tuya

Alimentación USB DC5V (Incluida)



COLOCACIÓN ALARMA SEGURIDAD SENSOR GAS NATURAL / METANO / BIOGAS

Estos gases tienden a elevarse. La posición correcta es cerca del techo o en puntos altos. Aproximadamente a 30cm del techo.

Para más información consultar ficha técnica

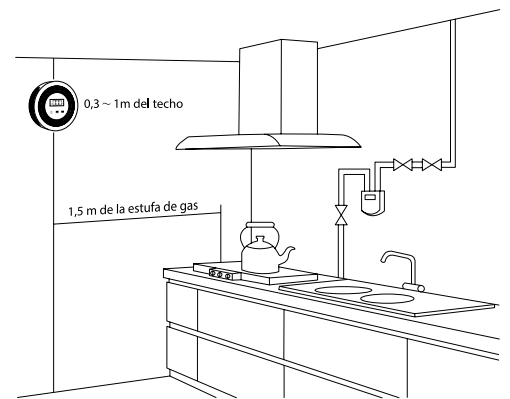

CON SONIDO ALARMA

DETECTOR DE HUMO

WiFi SGR-028 89,25€



tuya

85dB

Pila DC3V CR123A / CR17335 (Incluida)



COLOCACIÓN DETECTOR DE HUMO

Debe ubicarse entre las áreas para dormir y las posibles fuentes de incendio, como salas de estar y cocinas. Debe colocarse en el centro del techo en una habitación

Para más información consultar ficha técnica

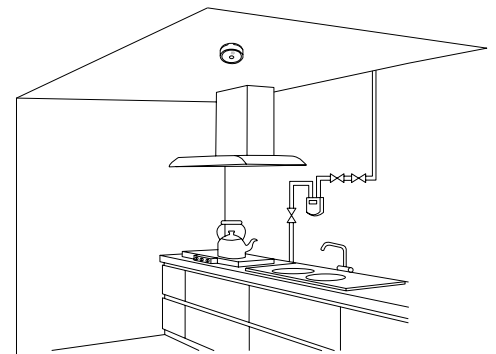



CON SONIDO ALARMA

DETECTOR DE MONÓXIDO DE CARBONO

WiFi

SGR-027

89,25€



85dB

Pilas DC3V AAA 2*1.5V (Incluidas)



tuya



COLOCACIÓN DETECTOR DE MONÓXIDO DE CARBONO

Debe instalarse al nivel de los ojos, es decir a una altura de entre 1,5 y 1,7 metros y como máximo a 1 metro de la fuente de emisión.

Para más información consultar ficha técnica

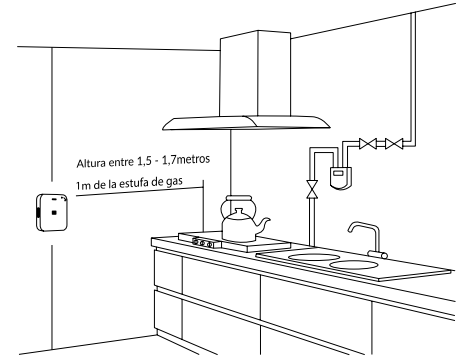

Altura entre 1,5 - 1,7 metros
1m de la estufa de gas



Serie termostatos

**CONTROLA LA TEMPERATURA A DISTANCIA
DESDE TU SMARTPHONE O LA VOZ**

Termostato WiFi inteligente **tuya**, controlador de temperatura para **caldera de gas y termo eléctrico**.

TERMOSTATO CALDERA WIFI-TUYA
CON ACCESORIO REMOTO

TERM-001 - 245,52€



COMPATIBLE
CON APP

tuya

"Compatible con los principales asistentes de voz
(asistente de Google*, Amazon*, Alexa* ... etc.)"

COMPATIBLE
CON SISTEMA
DE VOZ

Alexa

Estas marcas son propiedad de sus respectivos propietarios,
y como tal, son reconocidas por Atmoss Electric Equipment S.L.
y son utilizadas únicamente con fines enunciativos.



Funciona con Google Home.
SUPERFICIE

**EL WIFI SOLO FUNCIONA CUANDO ESTÁ
CONECTADO POR USB o a 230V**



Ficha técnica



Video vinculación

Termostato de **caldera**

TERMOSTATO DIGITAL DE CALDERA

TERM-011 - 68,85€



Ficha técnica



Instrucciones

NEW!



Características:

Alimentación	– 2 baterías alcalinas AA 1,5 V
Precisión de visualización	– 0,5 °C
Sensor de sonda	– NTC (10K) ±1 %
Capacidad de contacto (relé HF)	– 5 A / 30 VDC
Capacidad de contacto (relé NEC)	– 2 A / 30 VDC
Temperatura de funcionamiento	– 0 ~ 50 °C
Rango de ajuste de temperatura	– 5 ~ 35 °C
Rango de visualización de temperatura	– 0 ~ 40 °C
Salida	– Relé conmutador
Condición de aislamiento	– Entorno normal
Programa de funcionamiento semanal	– Configuración de ciclo
Instalación – Montaje en pared o sobre base con batería	
Dimensiones – 86 x 86 x 29 mm	
Tipo de control – Calefacción o refrigeración (contacto único)	
Diferencial de conmutación – 0,5 °C	



- Termostato caldera WiFi inteligente **tuya**, controlador de temperatura para **caldera de gas y termo eléctrico**.



COMPATIBLE CON APP **tuya**

"Compatible con los principales asistentes de voz (asistente de Google®, Amazon®, Alexa® ... etc.)"

COMPATIBLE CON SISTEMA DE VOZ **Alexa**

Estas marcas son propiedad de sus respectivos propietarios, y como tal, son reconocidas por Atmoss Electric Equipment S.L. y son utilizadas únicamente con fines enunciativos.

TERMOSTATO CALDERA WIFI-TUYA

TERM-006 - 119,16€

Características: Instrucciones



- | | |
|-----------------------------------|------------------------------------|
| 1. Fuente de alimentación: | 100 ~ 240V |
| 2. Carga actual: | ≤3A (caldera) |
| 3. Consumo de energía: | <1w |
| 4. Material externo: | PC + ABS (retardante de llama) |
| 5. Elemento sensor: | CNT |
| 6. Establecer temperatura. Rango: | 5-95°C |
| 7. Temp. establecida del piso: | 5-60°C |
| 8. Precisión del rango: | ≤1°C |
| 9. Dimensión: | 86 x 90 x 14mm |
| 10. Temp ambiente: | 0-45°C, 5-95%RH (sin condensación) |
| 11. Temp de almacenamiento: | - 5 ~ 55°C |
| 12. Error de sincronización: | <1% |

- Termostato caldera WiFi inteligente **tuya**, controlador de temperatura para **caldera de gas y termo eléctrico**.



COMPATIBLE CON APP **tuya**

"Compatible con los principales asistentes de voz (asistente de Google®, Amazon®, Alexa® ... etc.)"

COMPATIBLE CON SISTEMA DE VOZ **Alexa**

Estas marcas son propiedad de sus respectivos propietarios, y como tal, son reconocidas por Atmoss Electric Equipment S.L. y son utilizadas únicamente con fines enunciativos.

NEW!



TERMOSTATO BOTÓN REGULABLE CALDERA WIFI-TUYA

TERM-007 - 133,98€

Características: Instrucciones

- | | |
|------------------------------|--------------------------------|
| 1. Alimentación: | 3 pilas AAA - USB C |
| 2. Carga actual: | ≤3A (caldera) |
| 3. Material externo: | PC + ABS (retardante de llama) |
| 4. Elemento sensor: | CNT |
| 5. Temperatura de control: | 5 - 95°C |
| 6. Temperatura mínima | 0,5°C |
| 7. Precisión del rango: | ≤1°C |
| 8. Dimensión: | 86 x 90 x 14mm |
| 9. Temp de trabajo: | - 15 ~ 40°C |
| 10. Error de sincronización: | <1% |
| 11. Grado de protección: | IP20 |

* Según la nueva normativa ERP ha habido un cambio en la medición de Lúmenes y vatios, pero sigue emitiendo la misma cantidad de luz.

A medida que vayan entrando los nuevos modelos con ERP se irá actualizando en catálogo y cajas de color.

Puede haber variación respecto a la caja del producto (comprobar en ficha técnica), todos los datos en catálogo están correctos salvo error tipográfico.

- Termostato WiFi inteligente **tuya**, controlador de temperatura para **suelo radiante**.



COMPATIBLE CON APP **tuya**

"Compatible con los principales asistentes de voz (asistente de Google*, Amazon*, Alexa* ... etc.)"

COMPATIBLE CON SISTEMA DE VOZ **Alexa**

Estas marcas son propiedad de sus respectivos propietarios, y como tal, son reconocidas por Atmoss Electric Equipment S.L y son utilizadas únicamente con fines enunciativos.



TERM-004
NEGRO



TERM-004S - SYLVER
ACABADO ESPEJO

Características: [Instrucciones](#)

1. Sensor de temperatura: NTC
2. Precisión de temperatura: +- 1°C
3. Pantalla de visualización. LCD
4. Ambiente de trabajo: -5-50°C
5. Potencia de autoconsumo: <1w
6. Ajuste de temperatura: 5-60°C
7. Rango de visualización: 0-51°C
8. Corriente de carga: calentador eléctrico 16A (resistiva)
9. Tensión: AC100-240V, 50/60Hz

TERMOSTATO SUELO RADIANTE WIFI-TUYA

TERM-004 - 107,25€

TERMOSTATO SUELO RADIANTE WIFI-TUYA SYLVER

TERM-004S - 107,25€

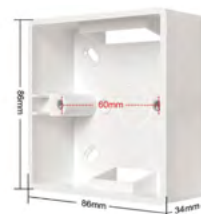

CAJA PARA TERMOSTATO
TERM-004

TERM-003 3,72€

Termostato digital
programable **FANCOIL**

TERM-010 - 95,85€



COMPATIBLE CON APP **tuya**

"Compatible con los principales asistentes de voz (asistente de Google*, Amazon*, Alexa* ... etc.)"

COMPATIBLE CON SISTEMA DE VOZ **Alexa**

Estas marcas son propiedad de sus respectivos propietarios, y como tal, son reconocidas por Atmoss Electric Equipment S.L y son utilizadas únicamente con fines enunciativos.

SISTEMA **FANCOIL**

NEW!



Características:

[Ficha técnica](#) [Instrucciones](#)

- Fuente de alimentación: CA 100-240 V, 50/60 Hz o CA/CC 24 V, 50/60 Hz
- Carga máxima: 5 A (carga resistiva); 3 A (carga inductiva)
- Precisión: ±0,5 °C
- Temperatura Sensor: NTC
- Rango de temperatura establecido: 5 °C - 35 °C
- Rango de temperatura de la pantalla: 0 °C - 99 °C
- Energía de autoconsumo: <2 W
- Tamaño: 86x86x12 mm

- Válvula regulable WiFi inteligente tuya, controlador de temperatura para radiadores.

VÁLVULA REGULABLE PARA RADIADORES WIFI-TUYA **TERM-009 - 118,5€**



"Compatible con los principales asistentes de voz (asistente de Google*, Amazon*, Alexa* ... etc.)"

Estas marcas son propiedad de sus respectivos propietarios, y como tal, son reconocidas por Atmoss Electric Equipment S.L y son utilizadas únicamente con fines enunciativos.

NEW!

Controlador WiFi TRV Inteligente

No requiere ningún controlador central, puede conectarse directamente



Control APP



Control por voz



Horario programable



Antihielo



Bloqueo infantil



Calibración de temperatura

Características:

[Instrucciones](#)

- Alimentación: 2 pilas AA (1.5V)
- Rango de presión: 0 – 10 bar
- Protección: IP20
- Temperatura: 0-50°C
- Rango de temperatura: 5°C – 35°C
- Conexión: M30 x 1.5mm
- Recorrido lineal: 6mm
- Dimensiones: 59.4 x 99.3 x 59.4 mm
- Peso: 145gr

Serie sistemas de seguridad

ALARMA

KIT DE ALARMA SEGURIDAD



tuya

Compatible con los principales sistemas de control por voz

Ref SGR-001
PVPR 144,27€



Contenido de la caja:

- 1u alarma
- 1u mando auxiliar
- 1u sensores movimiento
- 1u cargador USB
- 3u sensores puertas/ventana

**ADMITE HASTA 25
ACCESORIOS ENLAZADOS**

Accesorios compatibles con nuestro Kit de Alarma Atmoss con SGR-001

Sensor movimiento	Sensor puerta/ventana	Sensor agua	Timbre inalámbrico	Mando auxiliar
Ref SGR-002	Ref SGR-003	Ref SGR-004	Ref SGR-005	Ref SGR-006
PVPR 18,75€	PVPR 12,96€	PVPR 28,22€	PVPR 11,22€	PVPR 9,45€

Kit Sistema de seguridad GSM

- Compatible con los principales sistemas de control por voz.
- Tecnología GSM:

tuya



Conecta la alarma con el número telefónico programado previamente por el propietario, para informar de lo sucedido en el hogar por medio de un mensaje (SMS). La alarma de seguridad no dejará de sonar hasta que el usuario no de respuestas al sistema, indicando que todo se encuentra bien.

KIT SEGURIDAD PANEL + SENSOR MOVIMIENTO + MANDO. CON TARJETA SIM - SGR-024

Ref

PVPR

243,45€



Sistema de alarma

- Acabado moderno
- Resistente al agua y polvo
- Teclado táctil
- WiFi
- Tecnología GSM (Admite tarjeta SIM)

Incluye



Detector de movimiento PIR

Ref SGR-037
PVPR 20,04€



Sensor puerta / ventana

Ref SGR-036
PVPR 10,08€



Mando inalámbrico

Ref SGR-035
PVPR 12,36€



Llave RFID



Sirena

Accesorio



Añade al sistema de alarma

ALARMA SOLAR EXTERIOR PARA SGR-024

Ref SGR-040

PVPR 74,10€



WiFi



GSM (Tarjeta SIM)



Teclado táctil



SMS / Llamada alerta



Llave RFID

SOS

SOS



App mensaje push



Diferentes idiomas

Serie control de acceso

CERRADURA INTELIGENTE

Libertad y seguridad
Bloquea/Desbloquea tu puerta a distancia

Envío de notificaciones al smartphone



Compatible con **tuya**

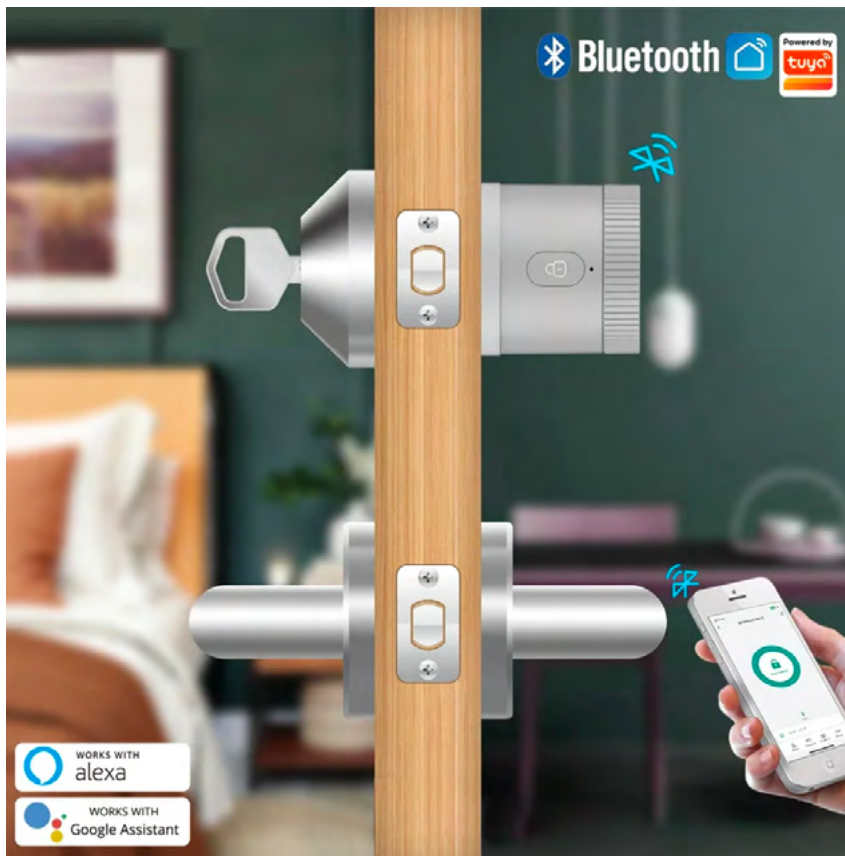

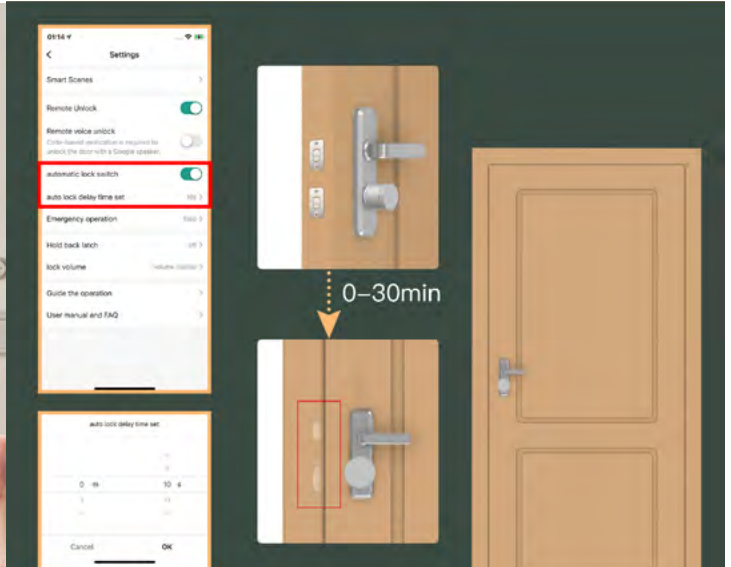
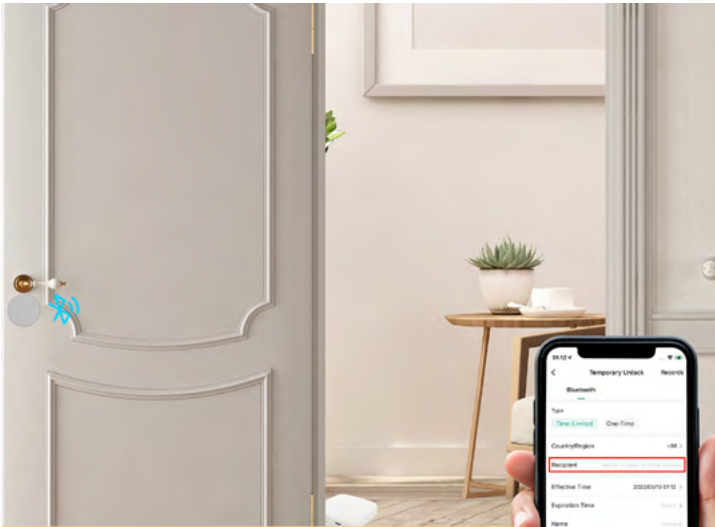

Desbloqueo/Bloqueo temporal con Hora

Añada la cuenta de Tuya para el desbloqueo temporal por otros como uso compartido del dispositivo.

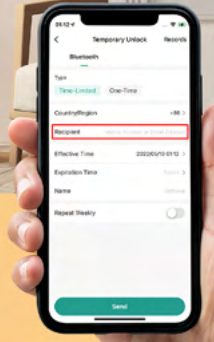

Ajuste el tiempo de retraso para el bloqueo automático. Bloquear automáticamente la puerta cuando se desbloquea dentro del tiempo establecido.

Instalación sencilla en 10 minutos sin perforar

1. Funciona con 4 pilas AA con 6 meses de autonomía.
2. Cifrado con encriptación grado bancario AES128 bit y encriptación TLS.
3. Protocolo BLE de bajo consumo
4. Tamaño compacto con instalaciones sencillas en minutos.

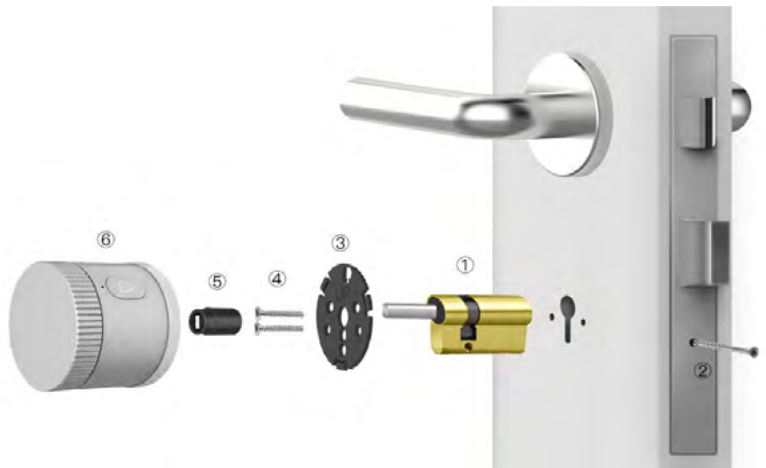

CERRADURA INTELIGENTE

tuya



Ref

SGR-039

PVPR

223,41 €

Puerta de enlace Gateway no incluido - Pilas no incluidas



Necesario incluir

Puerta de enlace Gateway



PUERTA DE ENLACE GATEWAY

tuya



Ref

CONTR-094

PVPR

64,23 €





Envío de notificaciones al smartphone

Compatible con **tuya**



CERRADURA INTELIGENTE SGR-048

Instalación muy sencilla
Accede sin llaves con total seguridad

Pestillo ajustable
60-70mm

Compatible con la mayoría de cerraduras de embutir

Puertas
35-50mm

Compatible con las puertas de 35-50 mm

Gran distancia
Apertura desde App

Hasta 15m sin obstáculos



5 FORMAS DE APERTURA



Huella dactilar

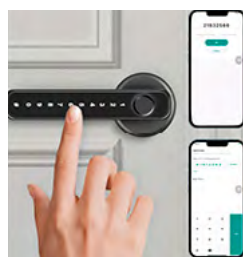

Más contraseñas: temporales y permanentes



Tarjeta (x 2uds)



Llave (x 2uds)



Orientación válida para Izquierda o derecha

Izquierda

Derecha

● Apertura de puerta

Presiona el botón en la manilla interior durante 2 segundos y la cerradura se quedará abierta.

Cualquiera podrá abrir la puerta sin contraseña ni huella.

Presiona el botón en la manilla interior nuevamente durante 2 segundos para desactivar el modo.



FÁCIL DE USAR



ESCANEAR PARA VER VIDEO INSTALACIÓN



MANUAL DE INSTRUCCIONES



CERRADURA INTELIGENTE

tuya



Ref SGR-048

PVPR 98,82€

Funciona con Pilas (No incluidas)



TECLADO CONTROL NUMÉRICO ACCESO PUERTA APP TUYA

Ref: SGR-041
PVPR: 104,85€



3 llaves digitales incluidas

KEY-041 060€

- Admite 2000 usuarios
- Velocidad de funcionamiento rápida, <20ms con 2000 usuarios
- Admite tarjeta, PIN, tarjeta+PIN
- Teclas retroiluminadas
- Tiempo de apertura de puerta ajustables
- Protección contra cortocircuitos
- Fácil de instalar y programar
- Admite 200 llaveros

Ref: SGR-042
PVPR: 48,45€



FUENTE DE ALIMENTACIÓN 12V



Ref: TIMB-399
PVPR: 18,30€



TIMBRE 12V ABS SONIDO DING DONG BLANCO



Interruptor tarjeta hotel

- Universal para todas las series de mecanismos



8800 W - TIEMPO 20s -

REF: SGR-044
PVPR: 19,12€

INTERRUPTOR DE TARJETA HOTEL

Blanco



SGR-044 19,12€

INTERRUPTOR DE TARJETA HOTEL

Negro

SGR-045 20,40€



CAJA DE EMPOTRAR INCLUIDO EN EL PRECIO

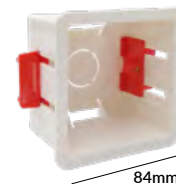

Corte 71mm

84mm
84mm

- Marco único monoblock
- Instalación Fase y Neutro
- No compatible con otros marcos de 2 y 3 elementos



Serie timbres



Posición horizontal

Ref

PVPR

TIMBRE DING DONG 230V *Blanco* TIMB-001 7,56€



85dB Sonido Ding-Dong



Posición vertical

DISEÑO MODERNO

TIMBRE DING DONG 230V *Blanco* TIMB-002 8,94€



90dB Sonido Ding-Dong



Posición vertical

TIMBRE DING-DONG *Blanco* TIMB-395 8,94€



80dB Sonido Ding-dong

38 sonidos

TIMBRE DING-DONG *Blanco* TIMB-393 18,54€



80dB 38Sonidos



TIMBRE DING-DONG *Blanco* TIMB-394 13,92€



80dB Sonido Ding-dong



TIMBRE BUZZER *30W 220V-240V SONIDO ZUMBADOR* Ref TIMB-004 PVPR 5,55€



Sonido ZUMBADOR



* Según la nueva normativa ERP ha habido un cambio en la medición de Lúmenes y vatios, pero sigue emitiendo la misma cantidad de luz. A medida que vayan entrando los nuevos modelos con ERP se irá actualizando en catálogo y cajas de color. Puede haber variación respecto la caja del producto (comprobar en ficha técnica), todos los datos en catálogo están correctos salvo error tipográfico.



TIMBRE INALÁMBRICO KINETIC - SIN BATERÍA
TIMB-396



38 Sonidas



4 Niveles volumen



Protección impermeable IP44



230v Receptor



Distancia larga (Hasta 150mts)



Señal fuerte

TIMBRE EXTERIOR INALÁMBRICO KINETIC BOTÓN Y ACCESORIO TIMBRE

TIMB-396 33,24€ **SISTEMA RF - NO FUNCIONA POR WIFI**



USB TIMBRE INALÁMBRICO
TIMB-397



38 Tonos



3 Niveles volumen



USB interface receptor enchufe



Amplo rango de trabajo



Fuerte penetración

TIMBRE EXTERIOR INALÁMBRICO CON BATERIA BOTÓN Y ACCESORIO TIMBRE

TIMB-397 17,46 € **SISTEMA RF - NO FUNCIONA POR WIFI**

Diferentes combinaciones

Puedes añadir uno o más receptores al pulsador.
O viceversa. Añadir varios pulsadores con el mismo receptor.



36 Tonos



100-120 metros (distancia abierta)



Señal LED



TIMBRE DING DONG 230V INALÁMBRICO CON BOTÓN

Ref: TIMB-003 PVPR: 22,56€



Batería 12V 23A



Bajo Medio Alto



38 Tonos



Rango de distancia 80mts



TIMBRE CON SENSOR DE MOVIMIENTO POR INFRARROJOS
RECEPTOR + SENSOR

Ref SGR-015 PVPR 40,44€



CONEXIÓN

- EL SENSOR UTILIZA 3 PILAS AAA
- EL EMISOR SE CONECTA A 230V AL ENCHUFE



ALTAVOZ DEL TIMBRE
PARA SENSOR SGR-016

Ref SGR-017 PVPR 24,36€



SENSOR DE MOVIMIENTO
PARA TIMBRE SGR-017

Ref SGR-016 PVPR 16,08€

SE PUEDE VENDER POR SEPARADO

- RANGO DE TRABAJO DE 100 METROS ENTRE RECEPTOR Y EMISOR

Ideal para puertas de entrada, marcos de ventanas, entradas de vehículos, caminos peatonales y cualquier lugar de su casa en el que desee recibir una alerta de movimiento. También es ideal para alertar a los propietarios de negocios que están trabajando en la parte trasera, o fuera de la vista, a los clientes que entran en su tienda.

**SERIE COMBINABLE
HASTA 32 ELEMENTOS**
POSIBILIDAD DE AÑADIR
VARIOS TIMBRES Y SENSORES



IDEAL PARA PUERTAS, TIENDAS,...



Rotación



100m
Distancia



IP65
Impermeable



38
Melodías



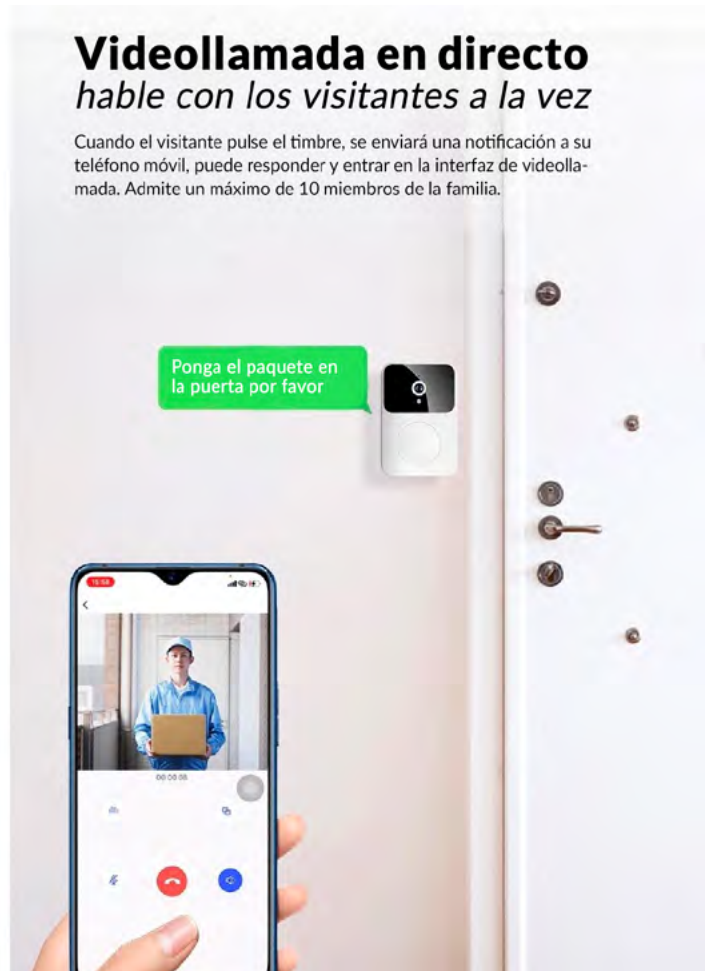

TIMBRE EXTERIOR INALÁMBRICO WIFI
CÁMARA BOTÓN Y ACCESORIO TIMBRE

TIMB-398 50,52€

- COMPATIBLE CON LA APP PROPIA
- NO COMPATIBLE CON TUYA

USO INTERIOR/
EXTERIOR

Alimentación batería recargable

Fácil instalación

Con adhesivo o tornillo

Pegamento adhesivo 3M
Fijación física con tornillos



VISIÓN NOCTURNA

ALTA DEFINICIÓN

Función de visión nocturna por infrarrojos.
Conmutación automática día/noche



TIMBRE CON CÁMARA WIFI TUYA CON BATERÍA

Ref PVPR

TIMBRE CON CÁMARA WIFI TUYA CON BATERÍA SGR-010 239,85€



1080P HD Video



Dos canales audio



Visión nocturna



166° Ángulo lente



Sensor de movimiento PIR



Gran autonomía hasta 6 meses



Espacio para tarjeta de memoria hasta 64Gb



DESCARGAR
Ficha técnica



+ CABLE FLAT DE CARGA ULTRASLIM FLEXIBLE

Carga por USB con cable FLAT Ultraslim (Cable incluido) Batería: 4500mAh - 21700 - 7V

6 MESES DE AUTONOMÍA



AÑADE EL TIMBRE SGR-011 PARA ESCUCHAR EL TIMBRE SIN NECESIDAD DE MOVIL

DESCARGAR
Ficha técnica

Ref PVPR
SGR-011 23,76€

Convierte tu timbre con cámara en **VIDEOPORTERO**

CON LA PASTILLA PULSADOR PARA CERRADURAS ELECTRÓNICAS CONTR-056



VISUALIZADOR MIRILLA CON PANTALLA

ALIMENTACIÓN POR USB O PILAS AAA

* NO DISPONE DE
• WIFI / BLUETOOTH



MIRILLA DIGITAL CON PANTALLA

Ref PVPR
SGR-009 109,80€

DESCARGAR
Ficha técnica



AUMENTA LA SEGURIDAD EN TU HOGAR.

Toma fotos o video AUTOMÁTICAMENTE

Al pulsar el timbre de la cámara, automáticamente la cámara hace una foto o graba video.



Función timbre



Visión infrarrojo



Foto/video



AAA Batería (NO INCLUIDA)



Ángulo 166°



Fácil instalación



Función no molestar



Espacio para tarjeta micro SD (NO INCLUIDA)

Series **videoportero**
con monitor 7"

Envío de notificaciones
al smartphone



Compatible con **tuya**

**MONITOR
INCLUIDO**

1080P
FULL HD

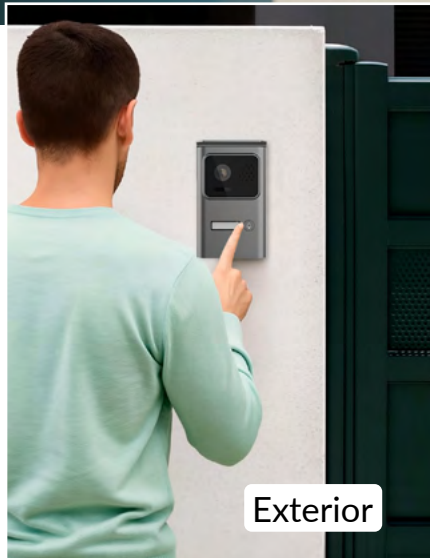

Exterior



Interior

**FACILIDAD DE
INSTALACIÓN
MEDIANTE
2 HILOS SIN
POLARIDAD**

DESCARGA LA
FICHA TÉCNICA



- FÁCIL INSTALACIÓN
- 2 HILOS SIN POLARIDAD
- SISTEMA TÁCTIL
- ALTA TECNOLOGÍA



TÁCTIL

1080P

7"
PULGADAS



ADMITE TARJETA
MICRO SD



FUENTE DE
ALIMENTACION
INCLUIDA



TARJETA RFID
INCLUIDA



WIFI

COMPATIBLE
con **tuya**

ALUMINIO

CAMARA
VISION
NOCTURNA

ALTA GAMA · ELEGANTE · CONECTIVIDAD



AÑADE LA **CUBIERTA
PROTECTORA** A TU
INSTALACIÓN PARA
HACERLO MÁS SEGURO
EN EL EXTERIOR

Ref **VPO-COVER** Ref 20,85 €

Compatible con **tuya**



	Ref	Ref
 VIDEOPORTERO CON MONITOR 7" 1080P WiFi Tuya tuya	VPO-001	419,85€

ACCESORIOS	Ref	Ref
MONITOR 7" PARA VPO-001	VPO-001P	239,70€

· Poner fuente alimentación para cada pantalla + LED Driver incluido ALM-05 I

Compatible hasta 4 pantallas

Compatible con **tuya**



	Ref	Ref
 Videoportero Negro - Monitor 7" VIDEOPORTERO CON MONITOR 7" 1080P WiFi Tuya tuya	VPO-002	365,85€

ACCESORIOS	Ref	Ref
MONITOR 7" PARA VPO-001	VPO-002P	233,76€

· Poner fuente alimentación para cada pantalla + LED Driver incluido ALM-05 I

Compatible hasta 4 pantallas

Compatible con **tuya**



	Ref	Ref
 Videoportero Gris - Monitor 7" VIDEOPORTERO CON MONITOR 7" 1080P WiFi Tuya tuya	VPO-003	365,85€

ACCESORIOS	Ref	Ref
MONITOR 7" PARA VPO-001	VPO-002P	233,76€

· Poner fuente alimentación para cada pantalla + LED Driver incluido ALM-05 I

Compatible hasta 4 pantallas

~~No Wifi~~ 



	Ref	Ref
 Videoportero Gris - Monitor 7" VIDEOPORTERO CON MONITOR 7" 1080P	VPO-004	251,85€

~~No Wifi~~ 



	Ref	Ref
 Videoportero Negro - Monitor 7" VIDEOPORTERO CON MONITOR 7" 1080P	VPO-005	251,85€

~~No Wifi~~ 



	Ref	Ref
 Videoportero Aluminio - Monitor 7" VIDEOPORTERO CON MONITOR 7" 1080P	VPO-006	257,85 €



	Ref	Ref
ALIMENTADOR P/CERRADURA 12V 5A	ALM-052	

* Según la nueva normativa ERP ha habido un cambio en la medición de Lúmenes y vatios, pero sigue emitiendo la misma cantidad de luz. A medida que vayan entrando los nuevos modelos con ERP se irá actualizando en catálogo y cajas de color. Puede haber variación respecto a la caja del producto (comprobar en ficha técnica), todos los datos en catálogo están correctos salvo error tipográfico.





Serie Mecanismos





Dynamic S20

MECANISMOS

10 UDS

100 UDS

DESCARGAR
FICHAS TÉCNICAS

Tecla.10 + Marco.10

Blanco.10



Tecla.10 + Marco.11

Aluminio.11



Tecla.11 + Marco.12

Antracita.12



Tecla.10 + Marco.20

Perla brushed .20

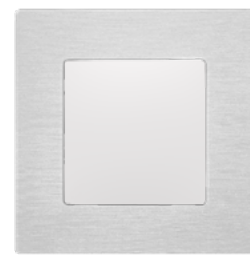

Tecla.10 + Marco.21

Aluminio brushed .21



COMPATIBLE

SERIE COLOR ANTRACITA S20

TODOS NUESTROS MECANISMOS S20 SON COMPATIBLES CON LAS TECLAS S30 ANTRACITA



S20.900.XX - Garra para mecanismo S20/S30



S20.901.XX - Piloto luminoso LED

NEW!



S20.130.10 - Tapa base doble RJ45 Blanco



S20.101.XX - Interruptor
S20.102.XX - Conmutador
S20.107.XX - Cruzamiento
S20.109.XX - Pulsador

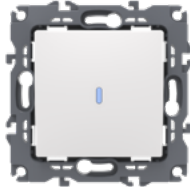

S20.103.XX - Interruptor luminoso LED
S20.110.XX - Pulsador luminoso LED
S20.122.XX - Conmutador luminoso LED
S20.124.XX - Cruzamiento luminoso LED

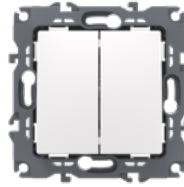

S20.104.XX - Interruptor doble
S20.105.XX - Conmutador doble
S20.136.10 - Conmutador + Cruzamiento

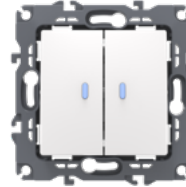

S20.106.XX - Interruptor doble luminoso
S20.123.XX - Conmutador doble luminoso



S20.108.XX - Pulsador luminoso timbre led

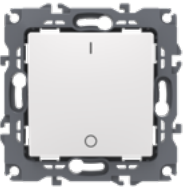

S20.111.XX - Interruptor bipolar



S20.120.XX - Interruptor de persianas
S20.134.10 - Pulsador doble para persiana



S20.112.XX - Base corriente Schuko 16A
8 UDS
80 UDS
PROTECCIÓN INFANTIL



S20.114.XX - Base corriente Schuko 16A + 2 Base USB 2.1A
6 UDS
60 UDS
PROTECCIÓN INFANTIL



NEW! CARGA RÁPIDA
S20.129.10 - Base corriente 16A + 2 USB Tipo A y C
6 UDS
60 UDS
PROTECCIÓN INFANTIL



S20.113.XX - Base doble USB 2.1A
6 UDS
60 UDS



S20.115.XX - Base teléfono RJ11 (CAT3)



S20.116.XX - Base red RJ45 (CAT6)

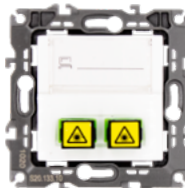

S20.133.XX - Base doble fibra óptica



S20.117.XX - Regulador giratorio

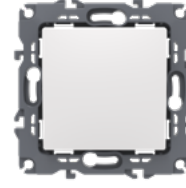

S20.118.XX - Tapa ciega



S20.121.XX - Tapa Universal TV + FM + SAT



S20.126.XX - Pulsador con símbolo luz



S20.127.XX - Pulsador con símbolo timbre



S20.128.XX - Pulsador luminoso con símbolo luz



S20.131.XX - Salida cables mecanismo



S20.132.XX - Timbre zumbador



S20.135.10 - Interruptor de tarjeta

Marco **BLANCO.10**

S20.301.10



20 UDS
200 UDS

S20.302.10



10 UDS
100 UDS

S20.303.10



15 UDS
150 UDS

S20.304.10



10 UDS
100 UDS

Marco **ALUMINIO.11**

S20.301.11



20 UDS
200 UDS

S20.302.11



10 UDS
100 UDS

S20.303.11



15 UDS
150 UDS

S20.304.11



10 UDS
100 UDS

Marco **ANTRACITA.12**

S20.301.12



20 UDS
200 UDS

S20.302.12



10 UDS
100 UDS

S20.303.12



15 UDS
150 UDS

S20.304.12



10 UDS
100 UDS

Marco **PERLA BRUSHED.20**

S20.301.20



20 UDS
200 UDS

S20.302.20

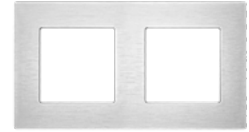

10 UDS
100 UDS

S20.303.20



15 UDS
150 UDS

S20.304.20



10 UDS
100 UDS

Marco **ALUMINIO BRUSHED.21**

S20.301.21



20 UDS
200 UDS

S20.302.21



10 UDS
100 UDS

S20.303.21



15 UDS
150 UDS

S20.304.21



10 UDS
100 UDS

* Según la nueva normativa ERP ha habido un cambio en la medición de Lúmenes y vatios, pero sigue emitiendo la misma cantidad de luz. A medida que vayan entrando los nuevos modelos con ERP se irá actualizando en catálogo y cajas de color. Puede haber variación respecto la caja del producto (comprobar en ficha técnica), todos los datos en catálogo están correctos salvo error tipográfico.

Dynamic S20 SUPERFICIE



S20.201.10 ZOCALO SUPERFICIE 1 ELEMENTO/BLANCO S20 PVPR - 4,96€



S20.202.10 ZOCALO SUPERFICIE 2 ELEMENTO/BLANCO S20 PVPR - 8 €



S20.203.10 ZOCALO SUPERFICIE 3 ELEMENTO/BLANCO S20 PVPR - 11,60 €

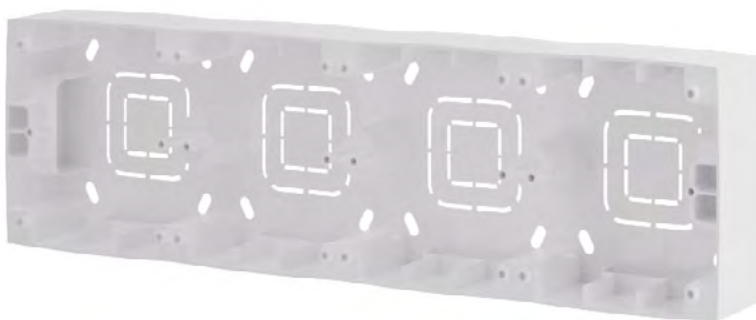

S20.204.10 ZOCALO SUPERFICIE 4 ELEMENTO/BLANCO S20 PVPR - 15,72 €



		Ref	PVPR
BASE DOBLE CORRIENTE 16A	Blanco	S20.125.10	11,68€

[DESCARGAR](#)
Ficha técnica



		Ref	PVPR
BASE DOBLE CORRIENTE 16A	Aluminio	S20.125.11	12,48€

[DESCARGAR](#)
Ficha técnica



















BASE 2 EN 1
Base doble para
1módulo











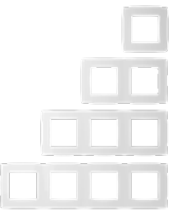

* Según la nueva normativa ERP ha habido un cambio en la medición de Lúmenes y vatios, pero sigue emitiendo la misma cantidad de luz. A medida que vayan entrando los nuevos modelos con ERP se irá actualizando en catálogo y cajas de color. Puede haber variación respecto la caja del producto (comprobar en ficha técnica), todos los datos en catálogo están correctos salvo error tipográfico.

Dynamic S20

Nueva serie de mecanismos **Dynamic S20** fabricados en policarbonato ignífugo, con sistema de conexión rápida y fijación por módulos. Varios colores disponibles y posibilidad de combinar teclas y marcos.

DESCRIPCIÓN	MECANISMO / TECLA-TAPA	.10	.11	TECLA-TAPA ANTRACITA S30	.12
					
 <ul style="list-style-type: none"> · Interruptor · Conmutador · Interruptor bipolar · Pulsador · Cruzamiento 	S20.101.XX	3,92€	4,92€	S30.601.12	1,48€
	S20.102.XX	5,68€	6,68€	S30.601.12	1,48€
	S20.111.XX	6,60€	7,72€	S30.611.12	1,64€
	S20.109.XX	4,24€	5,20€	S30.609.12	1,48€
	S20.107.XX	8,56€	9,80€	S30.607.12	1,56€
 <ul style="list-style-type: none"> · Pulsador con simbolo luz · Pulsador con simbolo timbre 	S20.126.XX	5,12€	5,88€	S30.628.12	1,64€
	S20.127.XX	4,24€	5,32€	S30.629.12	1,64€
 <ul style="list-style-type: none"> · Interruptor doble · Conmutador doble · Conmutador+Cruzamiento 	S20.104.XX	5,80€	7,32€	S30.604.12	2,08€
	S20.105.XX	9,36€	10,88€	S30.604.12	2,08€
	S20.136.10	12,88€			
 <ul style="list-style-type: none"> · Interruptor de persianas · Pulsador doble para persiana 	S20.120.XX	8,28€	9,56€	S30.620.12	1,64€
	S20.134.10	7,52€		S30.620.12	1,64€
 <ul style="list-style-type: none"> · Interruptor luminoso LED · Conmutador luminoso LED · Pulsador luminoso LED · Pulsador luminoso timbre LED · Cruzamiento luminoso · Pulsador luminoso con simbolo luz 	S20.103.XX	6,40€	7,48€	S30.603.12	1,60€
	S20.122.XX	8,04€	9,44€	S30.603.12	1,60€
	S20.110.XX	6,76€	8,28€	S30.610.12	1,60€
	S20.108.XX	6,76€	8,28€	S30.608.12	1,60€
	S20.124.XX	11,16€	12,32€	S30.627.12	1,72€
	S20.128.XX	6,76€	7,84€	S30.630.12	1,72€
 <ul style="list-style-type: none"> · Interruptor doble luminoso LED · Conmutador doble luminoso LED 	S20.106.XX	10,80€	12,48€	S30.606.12	2,12€
	S20.123.XX	14,28€	16,16€	S30.606.12	2,12€
 <ul style="list-style-type: none"> · Regulador giratorio 1-10V Máx. 300W LED 	S20.117.XX	57,20€	59,96€	S30.617.12	2,64€
 <ul style="list-style-type: none"> · Base corriente Schuko 16A Con protección infantil Conexión por tornillos · Base corriente Schuko 16A 2 puertos USB · Base corriente Schuko 16A 2 puertos USB Tipo A y C 	S20.112.XX	5,88€	6,80€	S30.612.12	2,00€
	S20.114.XX	48,16€	49,24€	S30.614.12	2,24€
	S20.129.10	62,48€			
 <ul style="list-style-type: none"> · Base doble USB 2.1A 	S20.113.XX	45,44€	47,36€	S30.613.12	1,56€
 <ul style="list-style-type: none"> · Base teléfono RJ11 (CAT3) · Base red RJ45 (CAT6) · Tapa base doble RJ45 Blanco 	S20.115.XX	7,28€	8,28€	S30.615.12	1,60€
	S20.116.XX	12,92€	14,80€	S30.616.12	1,60€
	S20.130.10	8,32€			
 <ul style="list-style-type: none"> · Tapa Universal TV - FM - SAT · Base doble fibra óptica · Interruptor de tarjeta 	S20.121.XX	2,12€	2,52€	S30.621.12	3,00€
	S20.133.10	11€			
	S20.135.10	63,16€			
 <ul style="list-style-type: none"> · Tapa salida de cable sin marco · Salida cables 16A con mecanismo · Tapa ciega · Timbre zumbador 	S20.119.XX	2,88€	4,56€		
	S20.131.XX	2,88€	4,56€		
	S20.118.XX	1,92€	2,84€		
S20.132.XX	21,84€	25€	S30.632.12	1,88€	

Marcos disponibles en:

									
		Blanco.10	Aluminio.11	Antracita.12	Perla brus.20	Aluminio brus.21			
	· Marco 1 elemento	S20.301.XX	1,16€	2,40€	2,60€	3,04€	3,04€		
	· Marco 2 elementos	S20.302.XX	1,68€	3,48€	4,12€	4,36€	4,36€		
	· Marco 3 elementos	S20.303.XX	2,60€	5,60€	6,08€	6,32€	6,32€		
	· Marco 4 elementos	S20.304.XX	4,28€	9,96€	10,44€	10,12€	10,12€		

Transporte no incluido. Para más información y descarga de fichas técnicas - www.atmoss.es -

TODOS LOS PRECIOS SON EN PVPR Y ESTÁN SUJETOS A MODIFICACIONES. LOS PRECIOS ESTÁN CORRECTOS SALVO ERROR TIPOGRÁFICO, EN ÚLTIMA INSTANCIA COMPROBAR EN TARIFA DE PRECIOS - COMPROBAR MEDIDAS CON EL ARTICULO EN FÍSICO YA QUE PUEDE HABER ERROR TIPOGRÁFICO

Precio PVPR**Combinación: Mecanismo con tecla/tapa + Marco (1elemento)**

Precio en color:

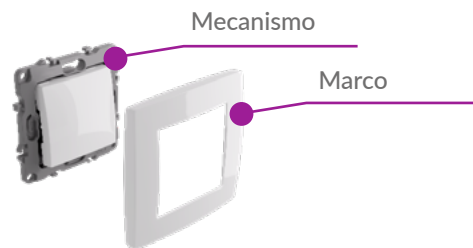
BLANCO .10 / ALUMINIO .11 / ANTRACITA .12

PRODUCTO COMPLETO	.10 BLANCO	.11 ALUMINIO	.12 ANTRACITA
Interruptor Unipolar	5,08€	7,32€	8€
Conmutador	6,84€	9,08€	9,76€
Interruptor bipolar	7,76€	10,12€	10,84€
Pulsador	5,40€	7,60€	8,32€
Cruzamiento	9,72€	12,20€	12,72€
Pulsador con símbolo luz	6,28€	8,28€	9,36€
Pulsador con símbolo timbre	5,40€	7,72€	8,48€
Interruptor doble	6,96€	9,72€	10,48€
Conmutador + cruzamiento	10,52€	13,28€	14,04€
Interruptor de persianas	9,44€	11,96€	12,52€
Pulsador doble para persiana	8,68€		11,76€
Interruptor luminoso led	7,56€	9,88€	10,60€
Conmutador luminoso led	9,20€	11,84€	12,24€
Pulsador luminoso led	7,92€	10,24€	10,96€
Pulsador luminoso timbre led	7,92€	10,68€	10,96€
Cruzamiento luminoso	12,32€	14,72€	15,48€
Pulsador luminoso con símbolo luz	7,92€	10,24€	11,08€
Interruptor doble luminoso led	11,96€	14,88€	15,52€
Conmutador doble luminoso led	15,44€	18,56€	19€
Regulador giratorio 1-10v	58,36€	62,36€	62,44€
Base corriente schuko 16A	7,04€	9,20€	10,48€
Base corriente schuko 16A 2 puertos USB	49,32€	51,64€	53€
Base corriente schuko 16A 2 puertos USB Tipo A y C	63,64€		
Base doble USB 2.1A	46,60€	49,76€	49,60€
Base teléfono RJ11 CAT3	8,44€	10,68€	11,48€
Base red RJ45 CAT6	14,08€	17,20€	12,12€
Tapa universal TV-FM-SAT	3,28€	4,92€	7,72€
Base doble fibra óptica	12,16€		
Interruptor de tarjeta	64,32€		
Tapa ciega	3,08€	5,24€	
Salida cables 16A	4,04€	6,96€	
Timbre zumbador	23€	27,40€	26,32€

* Según la nueva normativa ERP ha habido un cambio en la medición de Lúmenes y vatios, pero sigue emitiendo la misma cantidad de luz.

A medida que vayan entrando los nuevos modelos con ERP se irá actualizando en catálogo y cajas de color.

Puede haber variación respecto a la caja del producto (comprobar en ficha técnica), todos los datos en catálogo están correctos salvo error tipográfico.



Dynamic PLUS S30

MECANISMOS

10 UDS

100 UDS



DESCARGAR FICHAS TÉCNICAS



Tecla (Aluminio.11)
Cerquillo (Aluminio.11)
Marco (Blanco.10)

Tecla. (Antracita.12)
Cerquillo. (Antracita.12)
Marco (Blanco.10)

Tecla. (Aluminio.11)
Cerquillo. (Grafito.13)
Marco (Blanco.10)

Tecla. (Aluminio.11)
Cerquillo. (Grafito.13)
Marco (Negro brushed .16)

Tecla. (Blanco.10)
Cerquillo. (Blanco.10)
Marco (Blanco.10)

S30.501.00 Interruptor
S30.502.00 Conmutador
S30.509.00 Pulsador
S30.528.00 Pulsador símbolo luz
S30.529.00 Pulsador símbolo timbre



S30.503.00 Interruptor luminoso
S30.508.00 Pulsador luminoso timbre
S30.510.00 Pulsador luminoso
S30.522.00 Conmutador luminoso
S30.530.00 Pulsador luminoso símbolo luz
S30.527.00 Cruzamiento luminoso led



S30.504.00 Interruptor doble
S30.505.00 Conmutador doble
S30.507.00 Cruzamiento
S30.520.00 Interruptor de persianas
S30.534.00 Pulsador doble para persianas

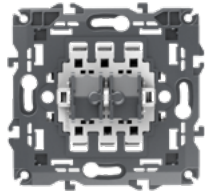

S30.506.00 Interruptor doble luminoso
S30.523.00 Conmutador doble luminoso

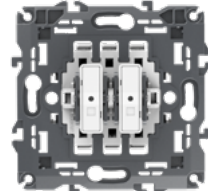

S30.511.00 - Interruptor bipolar

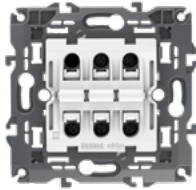

S30.532.00 - Timbre zumbador



S30.517.00 - Regulador giratorio 1-10V



S30.512.00 - Base corriente Schuko 16A



S30.514.00 - Base corriente 16A + 2USB

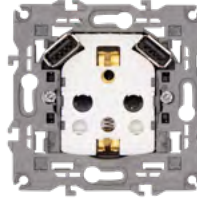

S30.513.00 - Base USB doble



8 UDS
80 UDS



6 UDS
60 UDS

6 UDS
60 UDS

S30.533.10 - Base doble fibra óptica



S30.635.10 - Interruptor de tarjeta



S30.515.00 - Base teléfono RJ11



S30.516.00 - Base Red RJ45

S30.700.10 - Marco embellecedor Blanco

30 UDS
300 UDS



S30.700.11 - Marco embellecedor Aluminio

30 UDS
300 UDS



S30.700.12 - Marco embellecedor Antracita

30 UDS
300 UDS



S30.700.13 - Marco embellecedor Grafito

30 UDS
300 UDS



* Según la nueva normativa ERP ha habido un cambio en la medición de Lúmenes y vatios, pero sigue emitiendo la misma cantidad de luz.

A medida que vayan entrando los nuevos modelos con ERP se irá actualizando en catálogo y cajas de color.

Puede haber variación respecto la caja del producto (comprobar en ficha técnica), todos los datos en catálogo están correctos salvo error tipográfico.

S30.601.XX - Tecla
S30.607.XX - Tecla Cruzamiento
S30.609.XX - Tecla pulsador

TECLAS  30 UDS  300 UDS

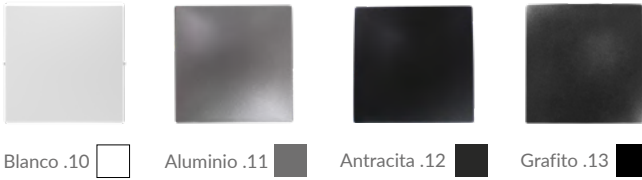

S30.603.10 - Tecla luminoso
S30.610.10 - Tecla pulsador luminoso
S30.627.10 - Tecla cruzamiento luminoso

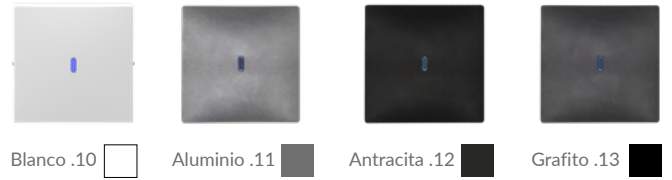

S30.604.XX - Tecla doble

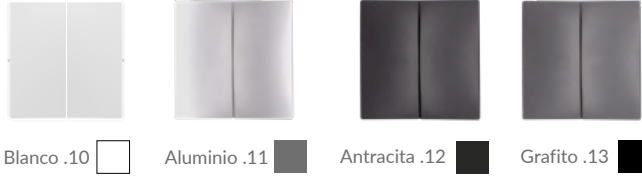

S30.606.XX - Tecla doble luminoso

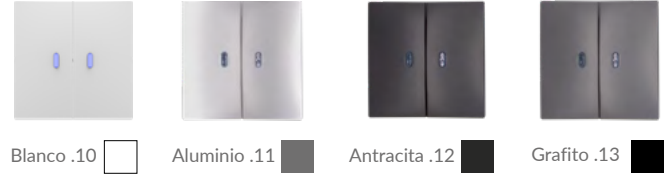

S30.629.XX - Tecla pulsador con símbolo timbre



S30.608.XX - Tecla timbre

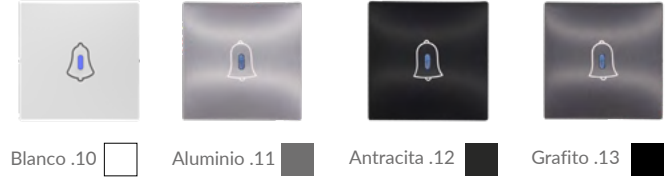

S30.628.XX - Tecla pulsador con símbolo luz



S30.630.XX - Tecla pulsador luminoso con símbolo luz

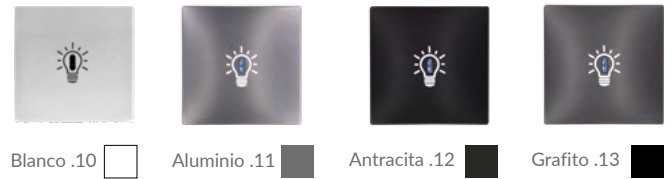

S30.620.XX - Tecla persiana

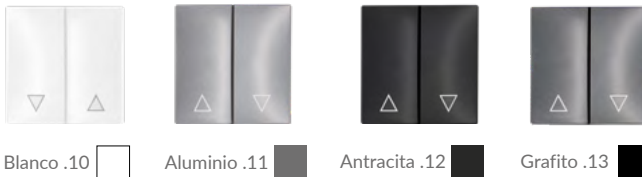

S30.634.10 - Tecla pulsador doble persiana



Marco PLÁSTICO BLANCO

S30.821.10

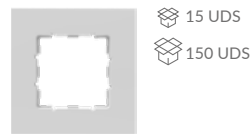

S30.822.10



S30.823.10



S30.824.10



Marco CRISTAL BLANCO

S30.801.10



S30.802.10

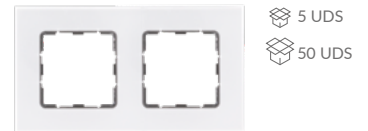

S30.803.10



S30.804.10



S30.611.XX - Tecla interruptor bipolar

TAPAS 30 UDS 300 UDS

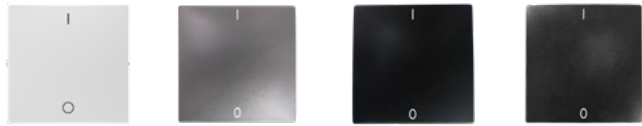

Blanco .10 Aluminio .11 Antracita .12 Grafito .13

S30.615.XX - Tapa base teléfono RJ11
S30.616.XX - Tapa base red RJ45

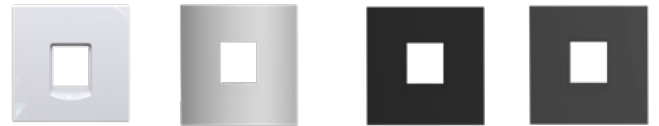

Blanco .10 Aluminio .11 Antracita .12 Grafito .13

S30.613.XX - Tapa base USB doble



Blanco .10 Aluminio .11 Antracita .12 Grafito .13

S30.617.XX - Tapa regulador giratorio 1-10V



Blanco .10 Aluminio .11 Antracita .12 Grafito .13

S30.621.XX - Tapa base TV + FM + SAT



Blanco .10 Aluminio .11 Antracita .12 Grafito .13

S30.632.XX - Tapa zumbador timbre



Blanco .10 Aluminio .11 Antracita .12 Grafito .13

S30.612.XX - Tapa base 16A 20 UDS 200 UDS



Blanco .10 Aluminio .11 Antracita .12 Grafito .13

S30.614.XX - Tapa base corriente 16A + 2USB 20 UDS 200 UDS



Blanco .10 Aluminio .11 Antracita .12 Grafito .13

S30.618.XX - Tapa ciega 10 UDS 100 UDS



Blanco .10 Aluminio .11 Antracita .12 Grafito .13

S30.631.XX - Tapa salida cables 16A 10 UDS 100 UDS

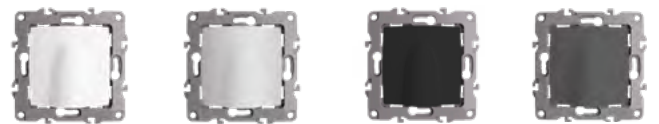

Blanco .10 Aluminio .11 Antracita .12 Grafito .13

Marco CRISTAL GRIS

Marco NEGRO BRUSHED

Marco ALUMINIO BRUSHED

S30.801.11



10 UDS
100 UDS

S30.802.11



5 UDS
50 UDS

S30.803.11



5 UDS
50 UDS

S30.804.11



5 UDS
50 UDS

S30.801.16



10 UDS
100 UDS

S30.802.16



5 UDS
50 UDS

S30.803.16



5 UDS
50 UDS

S30.804.16



5 UDS
50 UDS

S30.801.15



10 UDS
100 UDS

S30.802.15



5 UDS
50 UDS

S30.803.15



5 UDS
50 UDS

S30.804.15



5 UDS
50 UDS

















* Según la nueva normativa ERP ha habido un cambio en la medición de Lúmenes y vatios, pero sigue emitiendo la misma cantidad de luz.











A medida que vayan entrando los nuevos modelos con ERP se irá actualizando en catálogo y cajas de color.

Puede haber variación respecto la caja del producto (comprobar en ficha técnica), todos los datos en catálogo están correctos salvo error tipográfico.

Dynamic PLUS S30

Dynamic PLUS marco de cristal, plástico, aluminio. Teclas de policarbonato ignífugo, sistema de conexión rápida y fijación por módulos. Varios colores disponibles y posibilidad de combinar teclas, marcos, embellecedor.

	MECANISMO PVPR	TECLA-TAPA	.10	.11	.12	.13
	<ul style="list-style-type: none"> • Interruptor S30.501.00 4,04€ / S30.601.XX 0,60€ 1,48€ • Conmutador S30.502.00 5,40€ / S30.601.XX 0,60€ 1,48€ • Interruptor bipolar S30.511.00 7,88€ / S30.611.XX 0,72€ 1,64€ • Cruzamiento S30.507.00 8,80€ / S30.607.XX 0,76€ 1,56€ • Pulsador S30.509.00 4,36€ / S30.609.XX 0,60€ 1,48€ • Pulsador con símbolo LUZ S30.528.00 4,36€ / S30.628.XX 0,64€ 1,64€ • Pulsador con símbolo timbre S30.529.00 4,36€ / S30.629.XX 0,64€ 1,64€ 					
	<ul style="list-style-type: none"> • Interruptor luminoso LED S30.503.00 7,24€ / S30.603.XX 0,68€ 1,60€ • Conmutador luminoso LED S30.522.00 8,60€ / S30.603.XX 0,68€ 1,60€ • Cruzamiento luminoso LED S30.527.00 12,08€ / S30.627.XX 0,72€ 1,72€ • Pulsador luminoso LED S30.510.00 7,60€ / S30.610.XX 0,68€ 1,60€ • Pulsador luminoso símbolo luz S30.530.00 7,60€ / S30.630.XX 0,72€ 1,72€ • Pulsador luminoso timbre LED S30.508.00 7,60€ / S30.608.XX 0,68€ 1,60€ 					
	<ul style="list-style-type: none"> • Interruptor doble S30.504.00 8,64€ / S30.604.XX 0,72€ 2,08€ • Conmutador doble S30.505.00 8,48€ / S30.604.XX 0,72€ 2,08€ 					
	<ul style="list-style-type: none"> • Interruptor doble lumi. LED S30.506.00 12,20€ / S30.606.XX 0,80€ 2,12€ • Conmutador doble lumi. LED S30.523.00 14,64€ / S30.606.XX 0,80€ 2,12€ 					
	<ul style="list-style-type: none"> • Interruptor de persianas S30.520.00 7,08€ / S30.620.XX 0,72€ 1,64€ • Pulsador doble p/ persianas S30.534.00 7,48€ / S30.634.10 0,80€ S30.620.XX 1,64€ 					
	• Regulador giratorio 1-10V Máx. 300W LED S30.517.00 48,68€ / S30.617.XX 1,08€ 2,64€					
	• Base corriente Schuko 16A Con protección infantil Conexión por tornillos S30.512.00 5,80€ / S30.612.XX 1,20€ 2,00€					
	• Base corriente Schuko 16A Con protección infantil Conexión por tornillos 2 puertos USB S30.514.00 46,16€ / S30.614.XX 1,08€ 2,24€					
	• Base doble USB 2.1A S30.513.00 46,52€ / S30.613.XX 0,68€ 1,56€					
	• Base teléfono RJ11 (CAT3) S30.515.00 7,48€ / S30.615.XX 0,68€ 1,60€					
	• Base red RJ45 (CAT6) S30.516.00 9,36€ / S30.616.XX 0,68€ 1,60€					
	• Tapa Universal TV - FM - SAT Tapa - S30.621.XX 2,12€ 3,00€					
	• Timbre Zumbador S30.532.00 21,84€ / S30.632.XX 0,80€ 1,88€					
	• Base doble fibra óptica/Blanco S30.533.10 10,92€					
	• Interruptor de Tarjeta/Blanco S30.635.10 63,16€					
	• Tapa salida cables Tapa - S30.631.XX 2,88€ 4,56€					
	• Tapa ciega Tapa - S30.618.XX 1,96€ 2,84€					

		Blanco.10	Gris.11	Aluminio.11	Antracita.12	Grafito.13
	• Marco embellecedor S30.700.XX 1,08€ 1,96€ 1,96€ 1,96€					
	• Marco cristal 1 elemento S30.801.XX 14,32€ 14,32€					
	• 2 elementos S30.802.XX 32,20€ 32,20€					
	• 3 elementos S30.803.XX 47,20€ 47,20€					
	• 4 elementos S30.804.XX 72,00€ 72,00€					
	• Marco plástico 1 elemento S30.821.10 1,68€					
	• 2 elementos S30.822.10 2,92€					
	• 3 elementos S30.823.10 3,68€					
	• 4 elementos S30.824.10 4,80€					
			Aluminio brushed.15	Negro brushed.16		
	• Marco aluminio brushed 1 elemento S30.801.XX 18,52€ 18,52€					
	• 2 elementos S30.802.XX 36,32€ 36,32€					
	• 3 elementos S30.803.XX 51,08€ 51,08€					
	• 4 elementos S30.804.XX 66,24€ 66,24€					

Precio PVPR

Combinación: Mecanismo + tecla + Cerquillo + Marco

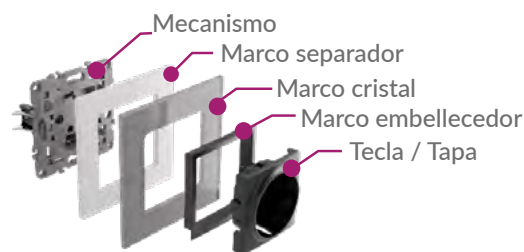

Precio en color:

- BLANCO.10
- ALUMINIO.11 (+ MARCO VIDRIO GRIS.11)
- ANTRACITA.12 (+ MARCO NEGRO BRUSHED.16)

PRODUCTO COMPLETO	.10 BLANCO	.11 ALUMINIO	.12 ANTRACITA
Interruptor Unipolar	7,40€	21,80€	26€
Conmutador	8,76€	23,16€	27,36€
Interruptor bipolar	11,36€	25,80€	30€
Cruzamiento	12,32€	26,64€	30,84€
Pulsador	7,72€	22,12€	56,32€
Pulsador con símbolo luz	7,76€	22,28€	26,48€
Pulsador con símbolo timbre	6,08€	22,28€	26,48€
Interruptor luminoso LED	10,68€	25,12€	29,32€
Conmutador luminoso LED	12,04€	26,48€	30,68€
Cruzamiento luminoso LED	15,56€	30,08€	34,28€
Pulsador luminoso LED	11,04€	25,48€	29,68€
Pulsador luminoso símbolo luz	11,08€	25,60€	29,80€
Pulsador luminoso timbre LED	11,04€	25,48€	29,68€
Interruptor doble	12,12€	27€	31,20€
Conmutador doble	11,96€	26,84€	31,04€
Interruptor doble luminoso LED	15,76€	30,60€	34,80€
Conmutador doble luminoso LED	18,20€	33,04€	37,24€
Interruptor de persianas	10,56€	25€	29,20€
Pulsador doble para persianas	11,04€	25,40€	29,60€
Regulador giratorio 1-10V	52,52€	67,60€	71,80€
Base corriente Schuko 16A	9,76€	24,08€	28,28€
Base corriente Schuko 16A + 2 puertos usb	50€	64,68€	68,88€
Base doble USB 2.1A	49,96€	64,36€	68,56€
Base teléfono RJ11	10,92€	25,36€	29,56€
Base red RJ45	12,80€	27,24	31,44€
Tapa universal TV+FM+SAT	4,88€	19,28€	23,48€
Timbre zumbador	25,40€	40€	44,20€
Base doble fibra óptica/blanco	13,68€		
Interruptor tarjeta/blanco	65,92€		
Tapa salida cables	5,64€	20,84€	25,04€
Tapa ciega	4,72€	19,12€	23,32€

* Según la nueva normativa ERP ha habido un cambio en la medición de Lúmenes y vatios, pero sigue emitiendo la misma cantidad de luz.

A medida que vayan entrando los nuevos modelos con ERP se irá actualizando en catálogo y cajas de color.

Puede haber variación respecto a la caja del producto (comprobar en ficha técnica), todos los datos en catálogo están correctos salvo error tipográfico.

Dynamic **ART S40**

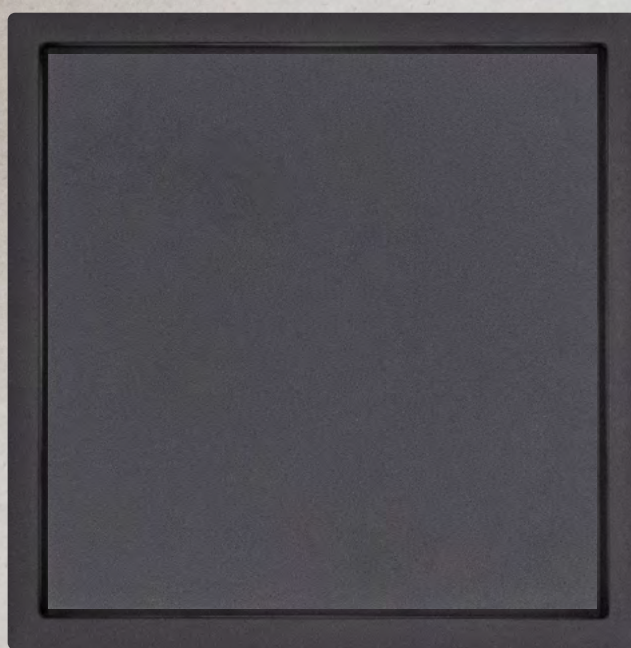



Cambio suave y silencioso.

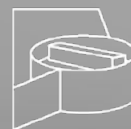

La fijación de múltiples puntos del marco de acero con piezas de montaje hace que todo el cuerpo sea más sólido y fiable.

Ag



Las partes de los contactos móviles están cubiertas de plata con un grosor no inferior a 0,4 mm



El plano de contacto de la conexión del cableado se realiza como "puente de arco" para una fijación más fiable del cable.



La cubierta de los contactos es de material ignífugo.

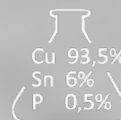

Cu 93,5%
Sn 6%
P 0,5%

Piezas conductoras: el bronce fosforado de alta calidad proporciona un alto grado de conductividad y durabilidad.



El grosor de las piezas conductoras de más de 0,8 mm evita su calentamiento y tensión.

Dynamic ART S40

DESCARGAR FICHAS TÉCNICAS

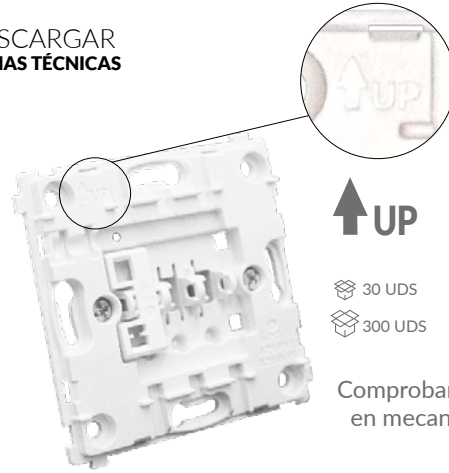
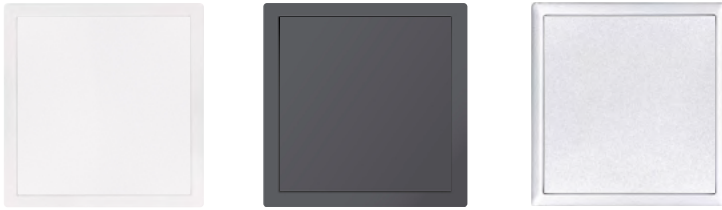

↑ UP

30 UDS
300 UDS

Comprobar flecha de posición en mecanismo y tapa/tecla.

TODOS LOS MECANISMOS NECESITAN MARCO Y TAPA/TECLA

MECANISMOS
10 UDS
100 UDS

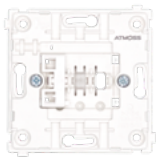

S40.501.00 INTERRUPTOR MECANISMO

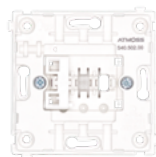

S40.502.00 CONMUTADOR MECANISMO



S40.504.00 INTERRUPTOR DOBLE MECANISMO

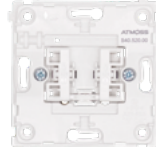

S40.520.00 PULSADOR PERSIANA MECANISMO



S40.505.00 CONMUTADOR DOBLE MECANISMO

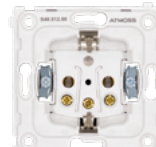

S40.512.00 BASE CORRIENTE 16A MECANISMO

8 UDS
80 UDS



S40.507.00 CRUZAMIENTO MECANISMO



S40.513.00 BASE CORRIENTE 16A CON USB TIPO A Y C MECANISMO

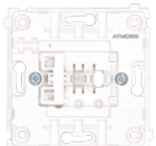

S40.508.00 PULSADOR TIMBRE MECANISMO

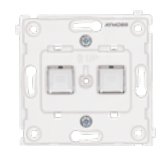

S40.516.10 BASE RED DOBLE RJ45 CAT.6 BLANCO MECANISMO

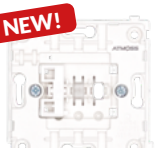

S40.509.00 PULSADOR PARA ESCALERA CON LED MECANISMO



S40.516.11 BASE RED DOBLE RJ45 CAT.6 ALUMINIO MECANISMO



S40.515.10 BASE TELF + RED RJ11 + RJ45 BLANCO MECANISMO



S40.516.17 BASE RED DOBLE RJ45 CAT.6 NEGRO MECANISMO

NEW!

S40.517.17 BASE RED DOBLE RJ45 CAT.6 NEGRO SIN CONECTOR MECANISMO



S40.515.11 BASE TELF + RED RJ11 + RJ45 ALUMINIO MECANISMO



S40.518.17 BASE RED UNO RJ45 CAT.6 NEGRO SIN CONECTOR MECANISMO



S40.515.17 BASE TELF + RED RJ11 + RJ45 NEGRO MECANISMO



S40.533.00 BASE DOBLE FIBRA ÓPTICA MECANISMO

SERIE BLANCO Brillo y Mate

30 UDS 300 UDS



S40.401.10
TECLA
BLANCO **BRILLO**

30 UDS 300 UDS



S40.402.10
TECLA DOBLE
BLANCO **BRILLO**

30 UDS 300 UDS

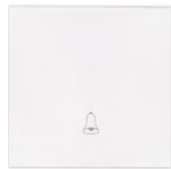

S40.403.10
TECLA SÍMBOLO
TIMBRE
BLANCO **BRILLO**

30 UDS 300 UDS



S40.404.10
TECLA DOBLE
CORTINA
BLANCO **BRILLO**

8 UDS 80 UDS



S40.618.10
TAPA CIEGA
BLANCO **BRILLO**

NEW!



S40.409.10
TECLA PULSADOR
ESCALERA CON LED
BLANCO **BRILLO**

S40.401.18
TECLA
BLANCO **MATE**

S40.402.18
TECLA DOBLE
BLANCO **MATE**

S40.403.18
TECLA SÍMBOLO
TIMBRE
BLANCO **MATE**

S40.404.18
TECLA DOBLE
CORTINA
BLANCO **MATE**

S40.618.18
TAPA CIEGA
BLANCO **MATE**

S40.409.18
TECLA PULSADOR
ESCALERA CON LED
BLANCO **MATE**

30 UDS 300 UDS



S40.405.10
TAPA BASE
CORRIENTE 16A
BLANCO **BRILLO**

NEW!



S40.408.10
TAPA BASE
CORRIENTE 16A
CON USB A y C
BLANCO **BRILLO**

30 UDS 300 UDS



S40.406.10 TAPA PARA
· BASE TELEF + RED. **RJ11 + RJ45**
· BASE RED DOBLE **RJ45**
· BASE DOBLE **FIBRA ÓPTICA**
BLANCO **BRILLO**

30 UDS 300 UDS



S40.410.10 TAPA PARA
· TAPA BASE UNO **S40.518.17**
RJ11 - RJ45
BLANCO **BRILLO**

S40.405.18
TAPA BASE
CORRIENTE 16A
BLANCO **MATE**

S40.408.18
TAPA BASE
CORRIENTE 16A
CON USB A y C
BLANCO **MATE**

S40.406.18 TAPA PARA
· BASE TELEF + RED. **RJ11 + RJ45**
· BASE RED DOBLE **RJ45**
· BASE DOBLE **FIBRA ÓPTICA**
BLANCO **MATE**

S40.410.18 TAPA PARA
· TAPA BASE UNO **S40.518.17**
RJ11 - RJ45
BLANCO **MATE**



30 UDS
300 UDS

S40.201.10
MARCO 1 ELEMENTO
BLANCO **BRILLO**

S40.201.18
MARCO 1 ELEMENTO
BLANCO **MATE**

8 UDS 80 UDS



S40.407.10
TAPA BASE
TV+FM+SAT
BLANCO **BRILLO**

S40.407.18
TAPA BASE
TV+FM+SAT
BLANCO **MATE**

8 UDS 80 UDS



S40.419.10
TAPA SALIDA CABLE
BLANCO **BRILLO**

S40.419.18
TAPA SALIDA CABLE
BLANCO **MATE**



15 UDS
150 UDS

S40.202.10
MARCO 2 ELEMENTO
BLANCO **BRILLO**

S40.202.18
MARCO 2 ELEMENTO
BLANCO **MATE**



8 UDS
80 UDS

S40.203.10
MARCO 3 ELEMENTO
BLANCO **BRILLO**

S40.203.18
MARCO 3 ELEMENTO
BLANCO **MATE**



8 UDS
80 UDS

S40.204.10
MARCO 4 ELEMENTO
BLANCO **BRILLO**

S40.204.18
MARCO 4 ELEMENTO
BLANCO **MATE**



NEW!

S40.205.10
MARCO 5 ELEMENTO
BLANCO **BRILLO**

* Según la nueva normativa ERP ha habido un cambio en la medición de Lúmenes y vatios, pero sigue emitiendo la misma cantidad de luz.

A medida que vayan entrando los nuevos modelos con ERP se irá actualizando en catálogo y cajas de color.

Puede haber variación respecto la caja del producto (comprobar en ficha técnica), todos los datos en catálogo están correctos salvo error tipográfico.

SERIE NEGRO MATE

30 UDS 300 UDS



S40.401.17

TECLA

NEGRO MATE

30 UDS 300 UDS

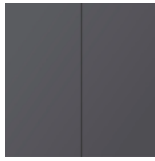

S40.402.17

TECLA DOBLE

NEGRO MATE

30 UDS 300 UDS



S40.403.17

TECLA SIMBOLO
TIMBRE

NEGRO MATE

30 UDS 300 UDS



S40.404.17

TECLA DOBLE
CORTINA

NEGRO MATE

8 UDS 80 UDS



S40.618.17

TECLA CIEGA

NEGRO MATE

NEW!



S40.409.17

TECLA PULSADOR
ESCALERA CON LED

NEGRO MATE

30 UDS 300 UDS



S40.405.17

TAPA BASE
CORRIENTE 16A

NEGRO MATE

NEW!



S40.408.17

TAPA BASE
CORRIENTE 16A
CON USB A y C

NEGRO MATE

8 UDS 80 UDS



S40.407.17

TAPA BASE
TV+FM+SAT

NEGRO MATE

8 UDS 80 UDS



S40.419.17

TAPA SALIDA
CABLE

NEGRO MATE

30 UDS 300 UDS



S40.406.17

TAPA PARA
· BASE TELEF + RED. RJ11 + RJ45
· BASE RED DOBLE RJ45
· BASE DOBLE FIBRA ÓPTICA

NEGRO MATE

30 UDS 300 UDS



S40.410.17

TAPA BASE UNO
RJ11 - RJ45
NEGRO MATE

TAPA PARA

S40.518.17

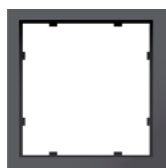

30 UDS
300 UDS

S40.201.17

MARCO 1 ELEMENTO

NEGRO MATE

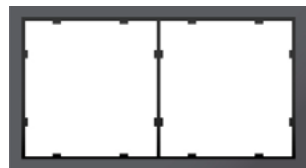

15 UDS
150 UDS

S40.202.17

MARCO 2 ELEMENTO

NEGRO MATE

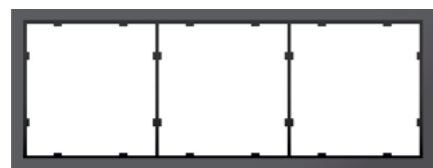

8 UDS
80 UDS

S40.203.17

MARCO 3 ELEMENTO

NEGRO MATE

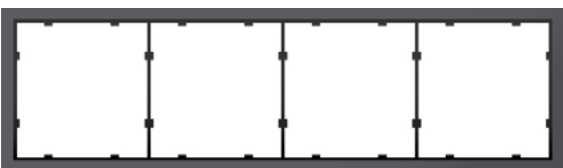

8 UDS
80 UDS

S40.204.17

MARCO 4 ELEMENTO

NEGRO MATE

NEW!

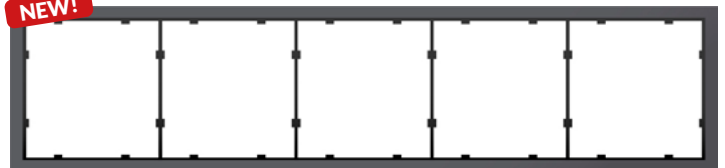

S40.205.17

MARCO 5 ELEMENTO

NEGRO MATE

SERIE ALUMINIO MATE

30 UDS 300 UDS



S40.401.11
TECLA

ALUMINIO MATE

30 UDS 300 UDS



S40.402.11
TECLA DOBLE

ALUMINIO MATE

30 UDS 300 UDS



S40.403.11
TECLA
SIMBOLO TIMBRE

ALUMINIO MATE

30 UDS 300 UDS



S40.404.11
TECLA DOBLE
CORTINA

ALUMINIO MATE

8 UDS 80 UDS



S40.618.11
TAPA CIEGA

ALUMINIO MATE



S40.409.11
TECLA PULSADOR
ESCALERA CON LED

ALUMINIO MATE

30 UDS 300 UDS



S40.405.11
TAPA BASE
CORRIENTE 16A

ALUMINIO MATE

NEW!



S40.408.11
TAPA BASE
CORRIENTE 16A
CON USB A y C

ALUMINIO MATE

8 UDS 80 UDS



S40.407.11
TAPA BASE
TV+FM+SAT

ALUMINIO MATE

8 UDS 80 UDS



S40.419.11
TAPA SALIDA
CABLE

ALUMINIO MATE

30 UDS 300 UDS



S40.406.11 TAPA PARA
· BASE TELEF + RED. **RJ11 + RJ45**
· BASE RED DOBLE **RJ45**
· BASE DOBLE **FIBRA ÓPTICA**

ALUMINIO MATE

30 UDS 300 UDS



S40.410.11 TAPA PARA
· TAPA BASE UNO **S40.518.17**
RJ11 - RJ45

ALUMINIO MATE



30 UDS
300 UDS

S40.201.11
MARCO 1 ELEMENTO

ALUMINIO MATE



15 UDS
150 UDS

S40.202.11
MARCO 2 ELEMENTO

ALUMINIO MATE



8 UDS
80 UDS

S40.203.11
MARCO 3 ELEMENTO

ALUMINIO MATE



8 UDS
80 UDS

S40.204.11
MARCO 4 ELEMENTO

ALUMINIO MATE

* Según la nueva normativa ERP ha habido un cambio en la medición de Lúmenes y vatios, pero sigue emitiendo la misma cantidad de luz. A medida que vayan entrando los nuevos modelos con ERP se irá actualizando en catálogo y cajas de color. Puede haber variación respecto la caja del producto (comprobar en ficha técnica), todos los datos en catálogo están correctos salvo error tipográfico.

Dynamic ART S40

Estilo renovado con su forma cuadrada y un marco fino. Se integran discretamente en cualquier ambiente. Una selección de materiales de alta calidad que ofrece todas las opciones para hacer que las ideas personales de decoración se hagan realidad.

MECANISMO PVPR / TECLA-TAPA

.10 .18 Mate .11 .17



· Interruptor	S40.501.00	6,40€ /	S40.401.XX	1,48€	2,20€	2,56€
· Conmutador	S40.502.00	7,08€ /	S40.401.XX	1,48€	2,20€	2,56€
· Cruzamiento	S40.507.00	10,60€ /	S40.401.XX	1,48€	2,20€	2,56€



· Interruptor doble	S40.504.00	8,04€ /	S40.402.XX	2,20€	2,84€	3,08€
· Conmutador doble	S40.505.00	9,68€ /	S40.402.XX	2,20€	2,84€	3,08€



· Pulsador timbre	S40.508.00	7,08€ /	S40.403.XX	1,88€	2,36€	2,88€
-------------------	------------	---------	------------	-------	-------	-------



· Pulsador persiana	S40.520.00	8,96€ /	S40.404.XX	2,36€	3,00€	3,60€
· Tecla pulsador escalera con led	S40.509.00	10,16€ /	S40.409.XX	1,84€	2,56€	2,84€



· Base corriente 16A	S40.512.00	6,04€ /	S40.405.XX	3,00€	3,72€	4,40€
----------------------	------------	---------	------------	-------	-------	-------



· Base corriente 16A USB Tipo A,C	S40.513.00	54,0€ /	S40.408.XX	2,92€	4,08€	4,28€
-----------------------------------	------------	---------	------------	-------	-------	-------



La base de teléfono y base de red doble tiene un color a elegir .10 / .11 / .17

MECANISMO



TAPA



· Base teléfono + Red (RJ11 + RJ45)	S40.515.XX	24,32€	26,08€	26,08€	/	S40.406.XX	1,72€	2,72€	3,28€
-------------------------------------	------------	--------	--------	--------	---	------------	-------	-------	-------



· Base Red doble RJ45 (CAT.6)	S40.516.XX	14,16€	15,76€	15,76€	/	S40.406.XX	1,72€	2,72€	3,28€
· Base Red doble RJ45 SIN CONECTOR	S40.517.17			7,12€	/	S40.406.XX	1,72€	2,72€	3,28€
· Base Red uno RJ45 SIN CONECTOR	S40.518.17			6,64€	/	S40.410.XX	1,60€	3€	3,40€



· Base doble fibra óptica	S40.533.00	17,12€				S40.406.XX	1,72€	2,72€	3,28€
---------------------------	------------	--------	--	--	--	------------	-------	-------	-------



· Tapa universal TV + FM + SAT	S40.407.XX	1,56€	2,64€	3,08€
--------------------------------	------------	-------	-------	-------



· Tapa Salida cable	S40.419.XX	5,04€	5,12€	6,72€
· Tapa Ciega	S40.618.XX	5,12€	5,92€	6,88€

	Blanco.....	10
	Blanco mate.....	18
	Aluminio.....	11
	Antracita.....	12
	Grafito.....	13
	Negro.....	17

Marcos disponibles en:

Blanco.10 Blanco mate.18 Aluminio.11 Negro.17

	· Marco plástico 1 elemento	S40.201.XX	1,56€	2,08€	2,44€	2,44€
	· Marco plástico 2 elementos	S40.202.XX	2,36€	4,08€	4,72€	4,72€
	· Marco plástico 3 elementos	S40.203.XX	5,88€	7,80€	11,84€	11,84€
	· Marco plástico 4 elementos	S40.204.XX	6,96€	9,04€	14,84€	14,84€
	· Marco plástico 5 elementos	S40.205.XX	9,44€			19,92€

Precio PVPR

Combinación: Mecanismo + Tecla/Tapa + Marco 1 elemento

Precio en color:

- BLANCO.10
- ALUMINIO.11
- BLANCO MATE .18
- NEGRO.17

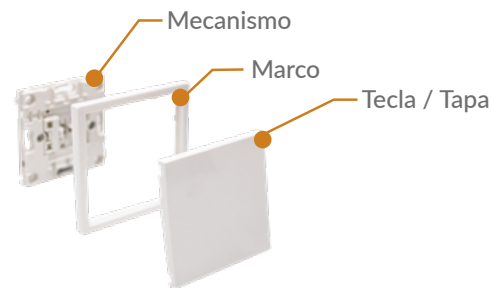

PRODUCTO COMPLETO	.10 BLANCO	.18 BLANCO MATE	.11 ALUMINIO .17 NEGRO
Interruptor Unipolar	9,44€	10,68€	11,40€
Conmutador	10,12€	11,36€	12,08€
Cruzamiento	13,64€	14,88€	15,60€
Interruptor doble	11,80€	12,96€	13,56€
Conmutador doble	13,44€	14,60€	15,20€
Pulsador timbre	10,52€	11,52€	12,40€
Pulsador persiana	12,88€	14,04€	15€
Base corriente 16A	10,60€	11,84€	12,88€
Base teléfono + red (RJ45+ RJ11)	27,60€	29,12€	31,80€
Base red doble RJ45	17,44€	18,96€	21,48€
Base doble fibra óptica	20,40€	--	22,84€
Tapa universal TV + FM + SAT	3,12€	4,20€	5,52€
Tapa salida cable	6,60€	7,20€	9,16€
Tapa ciega	6,68€	8,00€	9,32€

* Según la nueva normativa ERP ha habido un cambio en la medición de Lúmenes y vatios, pero sigue emitiendo la misma cantidad de luz.

A medida que vayan entrando los nuevos modelos con ERP se irá actualizando en catálogo y cajas de color.

Puede haber variación respecto la caja del producto (comprobar en ficha técnica), todos los datos en catálogo están correctos salvo error tipográfico.

Mecanismos S55

EXTERIOR IP55



DESCARGAR
FICHAS TÉCNICAS

Los **mecanismos S55** son la nueva propuesta de Atmoss de interruptores y enchufes para exterior y zonas al aire libre. Esta nueva gama cuenta con interruptores y enchufes para **superficies y empotrados** con un diseño ergonómico muy decorativo.

Lo mejor de estos mecanismos es que son capaces de resistir en el exterior a diversas condiciones medioambientales.

Ventajas

Diseño innovador: el estilo de los mecanismos es robusto y con perfil curvado, todo ello combinado con un estilo moderno y contemporáneo. También tienen un avanzado diseño ergonómico que facilita su instalación.

Empotrados y de superficie: tanto si quieres sustituir tus actuales mecanismos, como si tienes que realizar una nueva instalación, podrás elegir entre sus dos opciones.

Mecanismos seguros y robustos: gracias a su clasificación **IP55** son impermeables, mientras que su clasificación **IK06** los hace resistentes contra la suciedad el polvo y productos solventes, como cementos, pegamentos o removedores de pintura y barniz. Sus componentes están reforzados con fuertes herrajes para mecanismos, cajas y marcos rígidos, así como una junta de membrana impermeable. Esa clasificación IK06 significa también que son resistentes a los rayos UV, lo que significa que la versión en blanco polar no sufre decoloración con el tiempo.



Aplicaciones y combinaciones diferentes

- Posibilidad de empotrado o superficie.
- Protección IP55

**MÚLTIPLES
COMBINACIONES**

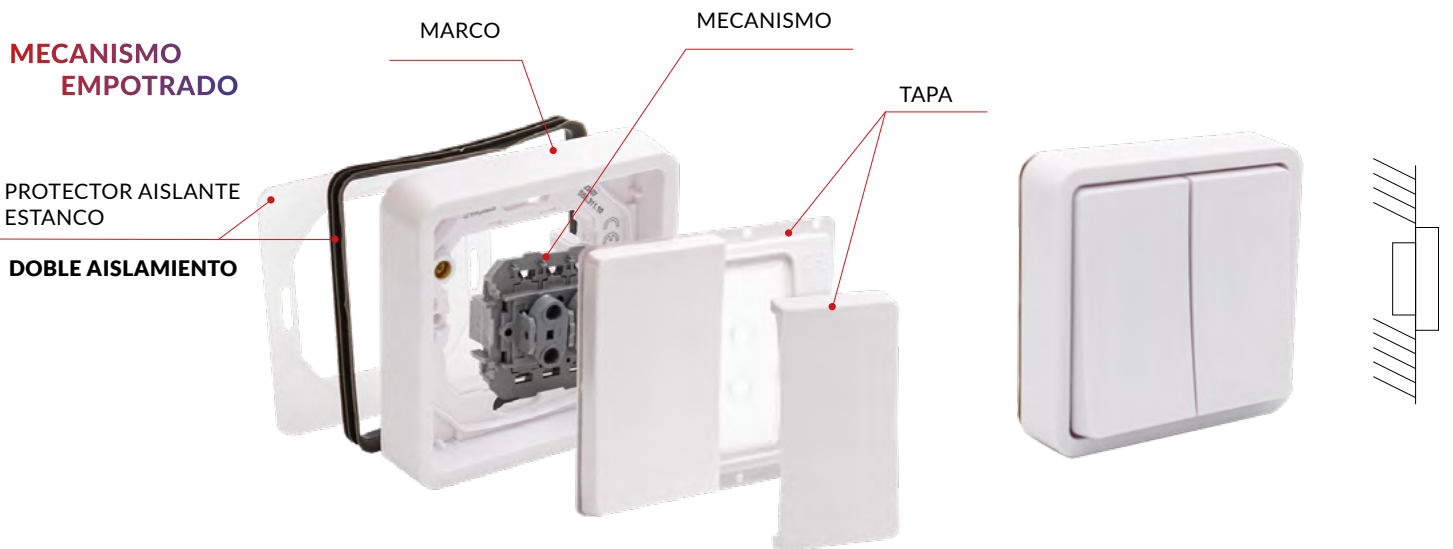

MECANISMO SUPERFICIE

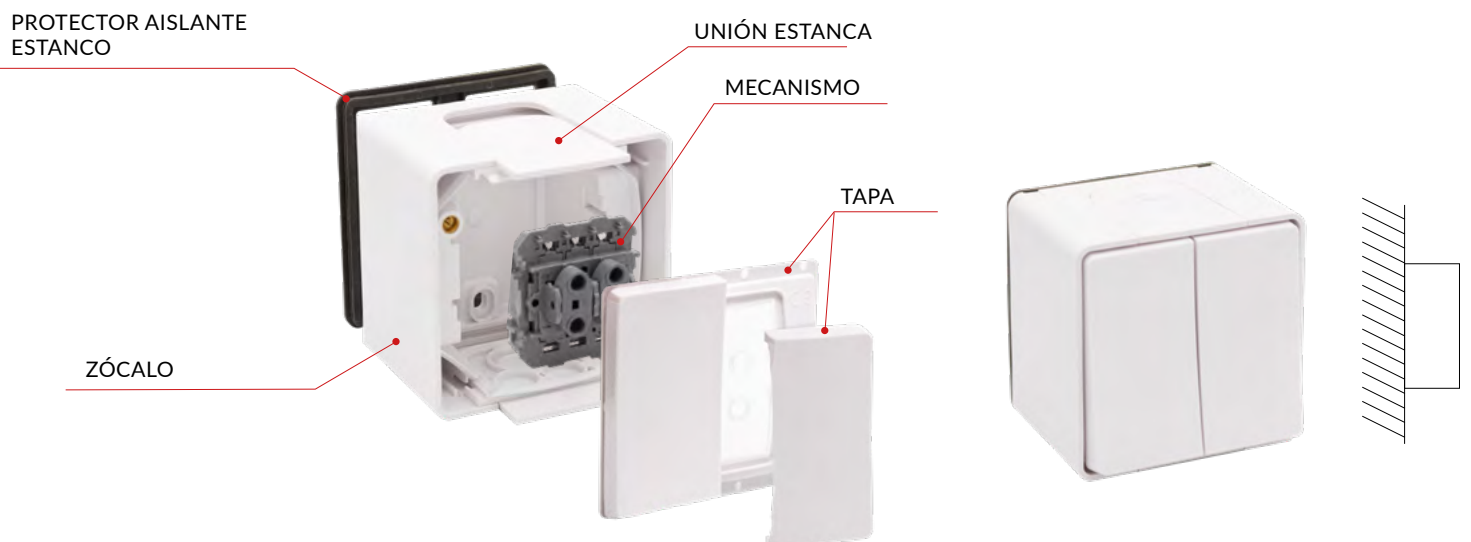



S55.112.10

BASE CORRIENTE 16A CON TAPA
BLANCO S55

8 UDS

PVPR - 8,24€



S55.110.10

PULSADOR LUMINOSO BLANCO S55

10 UDS

PVPR - 8,72€



S55.109.10

PULSADOR BLANCO S55

10 UDS

PVPR - 6,88€



S55.102.10

CONMUTADOR BLANCO S55

10 UDS

PVPR - 8,16€



S55.105.10

CONMUTADOR DOBLE BLANCO S55

10 UDS

PVPR - 11,44€

CAJA DE SUPERFICIE



S55.910.10

CAJA SUPERFICIE 1 ELEMENTO PARA MECANISMOS S55

 8 UDS

PVPR - **5,60€**

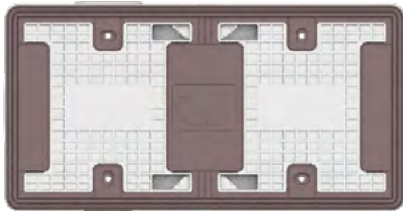

S55.911.10

CAJA SUPERFICIE 2 ELEMENTOS PARA MECANISMOS S55

 4 UDS

PVPR - **8,40€**

MARCO DE EMPOTRAR

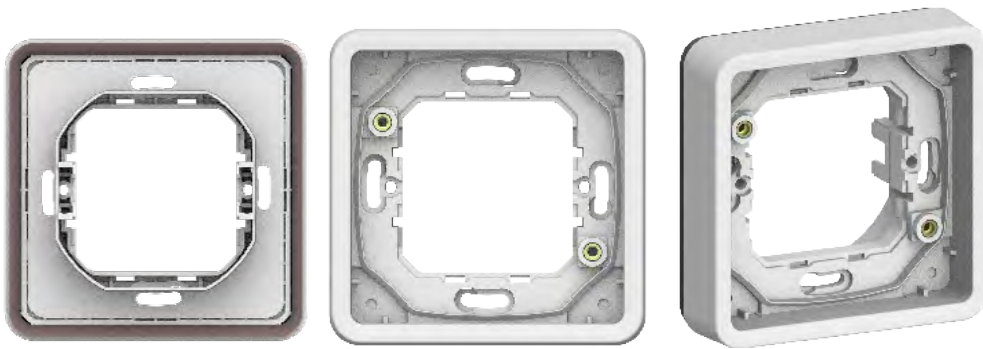

S55.311.10

MARCO 1 ELEMENTO BLANCO S55
EMPOTRAR

 12 UDS

PVPR - 5,44€

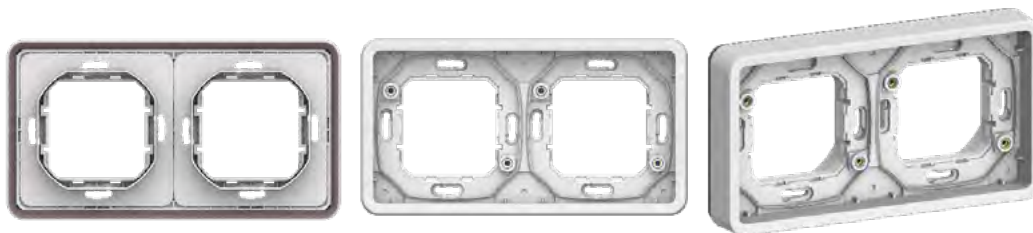

S55.312.10

MARCO 2 ELEMENTOS BLANCO S55
EMPOTRAR

 6 UDS

PVPR - 10,32€



NEW!

S55.313.10

MARCO 3 ELEMENTOS BLANCO S55
EMPOTRAR

 5 UDS

PVPR - 16,80€

**SOLO VÁLIDO PARA LOS
MODULOS ESTRECHOS**



S55.310.10

TAPA PARA MARCO EST/EMP VARIOS
MECANISMOS S55

14 UDS

PVPR - 3,44€



**Combina con los modulos
estrechos a tu gusto**



NEW!

S55.512.10

CONMUTADOR ESTRECHO BLANCO
MECANISMO S55

16 UDS

PVPR - 4,76€



S55.601.10

TAPA CIEGA MODULO ESTRECHO
MECANISMO S55

30 UDS

PVPR - 1,12€



S55.516.10

BASE RED RJ45 MODULO ESTRECHO
MECANISMO S55

16 UDS

PVPR - 13,92€



S55.535.10

BASE TV MODULO ESTRECHO
MECANISMO S55

16 UDS

PVPR - 9,68€



S55.513.10

BASE USB+TIPO C MODULO ESTRECHO
MECANISMO S55

12 UDS

PVPR - 45,92€

FICHA TÉCNICA

Precios PVPR

Referencia	Descripción	PVPR	UDS
S55.112.10	BASE CORRIENTE 16A CON TAPA BLANCO S55	PVPR - 8,24€	 8 UDS
S55.105.10	CONMUTADOR DOBLE BLANCO S20	PVPR - 11,44€	 10 UDS
S55.102.10	CONMUTADOR BLANCO S55	PVPR - 8,16€	 10 UDS
S55.109.10	PULSADOR EMPOTRAR BLANCO S55	PVPR - 6,88€	 10 UDS
S55.110.10	PULSADOR LUMINOSO EMPOTRAR BLANCO S55	PVPR - 8,72€	 10 UDS
S55.311.10	MARCO 1 ELEMENTO BLANCO S55	PVPR - 5,44€	 12 UDS
S55.312.10	MARCO 2 ELEMENTOS BLANCO S55	PVPR - 10,32€	 6 UDS
S55.312.10	MARCO 2 ELEMENTOS BLANCO S55	PVPR - 10,32€	 6 UDS
S55.910.10	CAJA SUPERFICIE 1 ELEMENTO PARA MECANISMOS S55	PVPR - 5,60€	 8 UDS
S55.911.10	CAJA SUPERFICIE 2 ELEMENTOS PARA MECANISMOS S55	PVPR - 8,40€	 4 UDS
S55.310.10	TAPA PARA MARCO EST/EMP VARIOS MECANISMOS S55	PVPR - 3,44€	 14 UDS
S55.516.10	BASE RED RJ45 MODULO ESTRECHO MECANISMO S55	PVPR - 13,92€	 16 UDS
S55.535.10	BASE TV MODULO ESTRECHO MECANISMO S55	PVPR - 9,68€	 16 UDS
S55.513.10	BASE USB+TIPO C MODULO ESTRECHO MECANISMO S55	PVPR - 45,92€	 12 UDS
S55.601.10	TAPA CIEGA MODULO ESTRECHO MECANISMOS S55	PVPR - 1,12€	 30 UDS

* Según la nueva normativa ERP ha habido un cambio en la medición de Lúmenes y vatios, pero sigue emitiendo la misma cantidad de luz.
A medida que vayan entrando los nuevos modelos con ERP se irá actualizando en catálogo y cajas de color.
Puede haber variación respecto la caja del producto (comprobar en ficha técnica), todos los datos en catálogo están correctos salvo error tipográfico.



Estanco 



CONEXIÓN CON TORNILLOS

IP65

PARA EXTERIOR

12

120



Descripción

Código

PVPR

Interruptor (10A-250V~)

S60.401.14

9,36€

Conmutador (10A-250V~)

S60.402.14

11,84€

Pulsador piloto LED (10A-250V~)

S60.403.14

13,92€

Conmutador doble (10A-250V~)

S60.404.14

14,24€

Base Schuko enchufe (16A-250V~)

S60.405.14

9,96€

Block doble base Schuko (16A-250V~)

S60.406.14

20,40€

Block base Schuko + Int - Conmut (16A-250V~)

S60.407.14

24,76€

Unión para mecanismo SUPERFICIE S60

S60.901.00

13,88€



ACLED-475



ACLED-476

Interruptor Temporizador táctil



Hecho de material de PVC de **ALTA CALIDAD, RESISTENTE Y DURADERO, FÁCIL DE LIMPIAR**. El sensor táctil es muy sensible y **FÁCIL DE USAR**, cuando lo tocas, el indicador LED se enciende. Relé de alta potencia de 16A, este interruptor es compatible con todo tipo de lámparas incandescentes y fluorescentes. Con **16 NIVELES DE AJUSTE DE TIEMPO**, oscila entre 2 minutos y 120 minutos, más ahorro de energía. Adecuado para **USO EN EXTERIORES E INTERIORES**, ampliamente utilizado en muchos lugares, como almacenes, escaleras, etc.

• Tiempo mínimo:
2 minutos

• Tiempo máximo:
2 horas

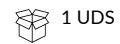

	REF	PVPR
INTERRUPTOR TÁCTIL TEMPORIZADOR DE PARED BLANCO	ACLED-475	59,70€
INTERRUPTOR TÁCTIL TEMPORIZADOR DE PARED NEGRO	ACLED-476	59,70€

[DESCARGAR FICHA TÉCNICA](#)

Descripción:

AHORRO DE ENERGÍA: Con 16 configuraciones de temporizador de 2 minutos a 120 minutos, puede encender y apagar las luces de su casa automáticamente, ahorrando tiempo y energía

ILUMINACIÓN VERSÁTIL: Relé de alto rendimiento de 16A, este interruptor de luz es compatible con todo tipo de lámparas incandescentes y fluorescentes para uso exterior o interior, versátil en muchos lugares como almacenes, escaleras, etc.

FÁCIL INSTALACIÓN : La instalación fácil ahorra tiempo. Apague la alimentación en el disyuntor para evitar descargas eléctricas. Simplemente retire su interruptor existente, instale el interruptor de luz y encienda el disyuntor

SENSOR TÁCTIL LED: El sensor táctil es muy sensible y fácil de usar. Cuando lo tocas, la luz LED se enciende para ayudarte a localizar fácilmente los interruptores de luz en la oscuridad



Uso ideal para:

Almacenes



Garajes

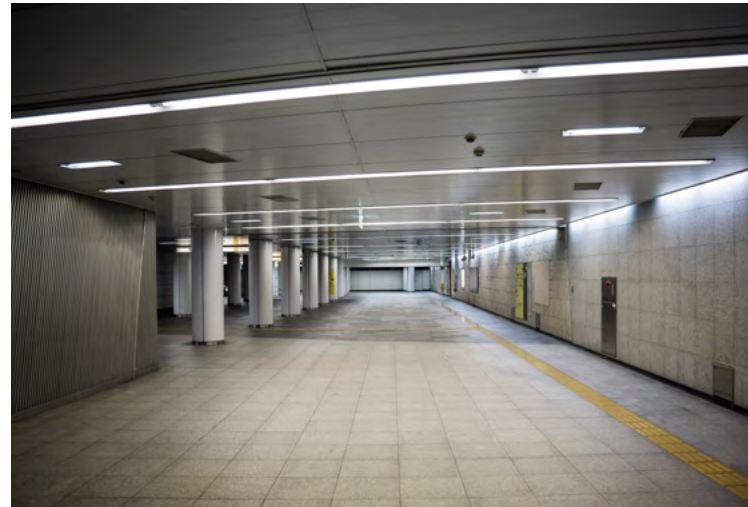

Trasteros

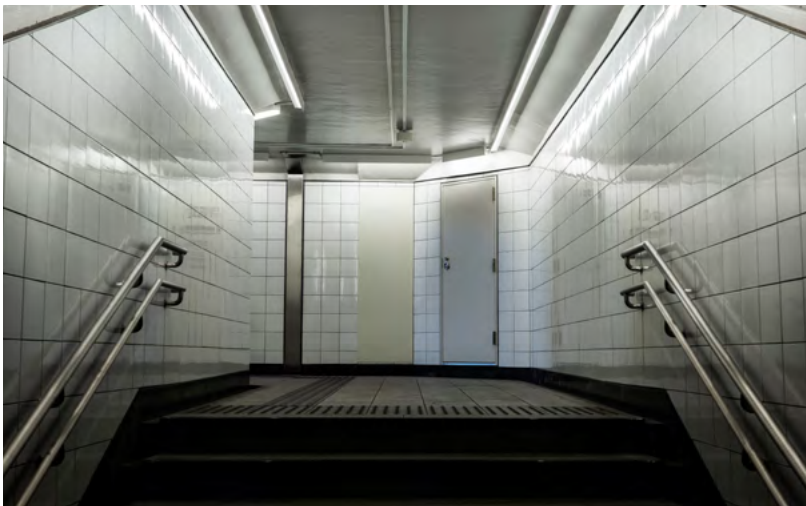

Escaleras



PROGRAMACIÓN HORARIO

16 MODOS

Tenga en cuenta que la barra negra indica la posición del interruptor DIP.

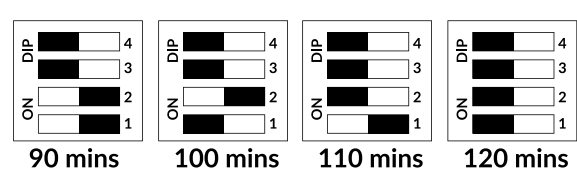
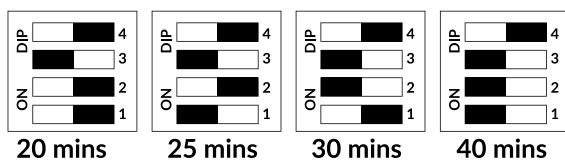
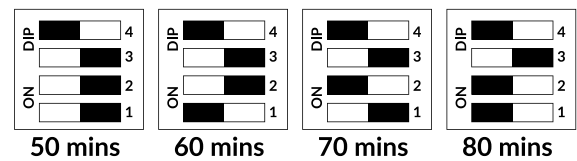
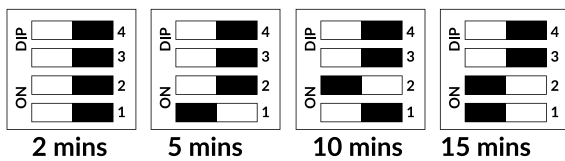

* Según la nueva normativa ERP ha habido un cambio en la medición de Lúmenes y vatios, pero sigue emitiendo la misma cantidad de luz. A medida que vayan entrando los nuevos modelos con ERP se irá actualizando en catálogo y cajas de color. Puede haber variación respecto la caja del producto (comprobar en ficha técnica), todos los datos en catálogo estan correctos salvo error tipográfico.

ATMOSS[®]



Serie **PEQUEÑO MATERIAL**
ELÉCTRICO

NEW DESIGN | MODERNO Y MINIMALISTA



Botón On/Off
Led indicador

Contactos de bronce

- Alta resistencia a la corrosión.
- Alta dureza.
- Mayor durabilidad.

BASE USB

Tipo A 20w - 2000mA

Tipo C - Carga rápida
18w - 3000mA

CARGA RÁPIDA

Embalaje en bolsa de pvc

MultiFijación Fijación en pared - superficie



Incluye tornillos y tacos para anclaje en pared

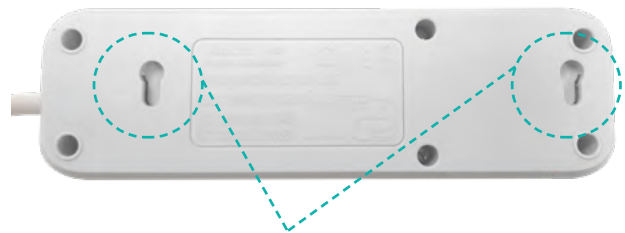
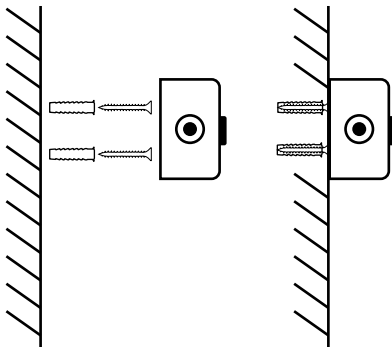

Anclaje para fijación en pared

Botón On/Off

DISEÑO
MINIMALISTA



BASE TOMAS CON CABLE + INTERRUPTOR + PROTECCIÓN INFANTIL



40 UDS



MTE-0001 - Base 3 tomas

250v - 16A
IP20
Potencia máx: 3680w
Cable: 3 x 1.5mm² - 1.4m

PVPR
14,10€



MTE-0002 - Base 4 tomas

250v - 16A
IP20
Potencia máx: 3680w
Cable: 3 x 1.5mm² - 1.4m

PVPR
15,30€



MTE-0005 - Base 4 tomas + USB

250v - 16A
IP20
Potencia máx: 3680w
Cable: 3 x 1.5mm² - 1.4m
Base USB.

PVPR
41,88€

Base A - 20w - 2000mA
Base C - 18w - 3000mA



MTE-0003 - Base 5 tomas

250v - 16A
IP20
Potencia máx: 3680w
Cable: 3 x 1.5mm² - 1.4m

PVPR
16,50€



MTE-0004 - Base 6 tomas

250v - 16A
IP20
Potencia máx: 3680w
Cable: 3 x 1.5mm² - 1.4m

PVPR
17,85€

* Según la nueva normativa ERP ha habido un cambio en la medición de Lúmenes y vatios, pero sigue emitiendo la misma cantidad de luz. A medida que vayan entrando los nuevos modelos con ERP se irá actualizando en catálogo y cajas de color. Puede haber variación respecto la caja del producto (comprobar en ficha técnica), todos los datos en catálogo están correctos salvo error tipográfico.

Base de enchufe SIN CABLE

- Tapa desmontable
- Fácil conexión de cables
- Anclaje en pared

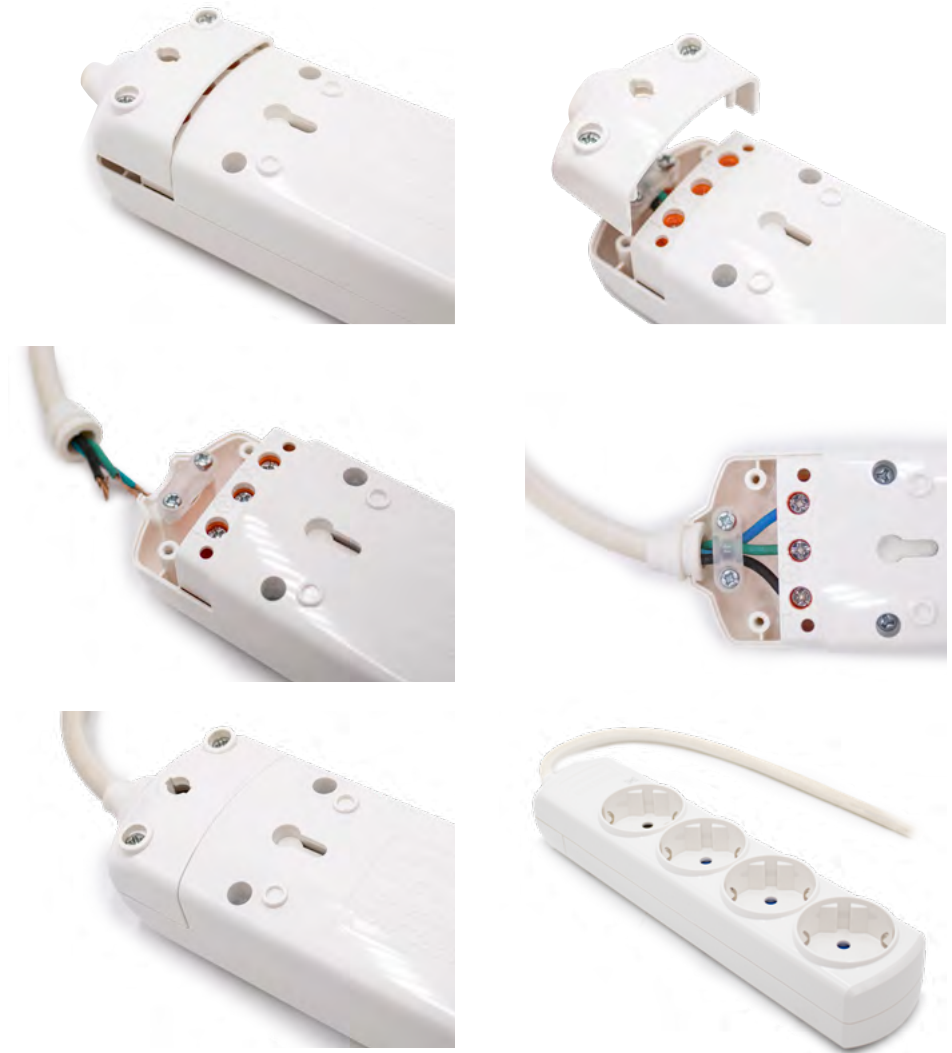

BASE TOMAS SIN CABLE + PROTECCIÓN INFANTIL



SIN CABLE



1 UD

MTE-0028 - Base 3 tomas

PVPR
7,47€

250v - 16A
IP20
Potencia máx: 3680w
Sin Cable



MTE-0029 - Base 4 tomas

8,37€

250v - 16A
IP20
Potencia máx: 3680w
Sin Cable



Base de enchufe EXTERIOR IP54



1 UD



MTE-0040 - Base 3 tomas

250v - 16A
IP54
Potencia máx: 3680w

PVPR
18,90€



1 UD

MTE-0041 - Base 6 tomas

250v - 16A
IP54
Potencia máx: 3680w

PVPR
23,85€

BASE / CLAVIJA SCHUKO GOMA 16A



25 UDS

MTE-0009 - Macho Negro

250v - 16A
IP20

PVPR

2,43€



25 UDS

MTE-0010 - Macho Blanco

250v - 16A
IP20

PVPR

2,43€



25 UDS

MTE-0016 - Hembra Negro

250v - 16A
IP20

PVPR

3,78€



25 UDS

MTE-0015 - Hembra Blanco

250v - 16A
IP20

PVPR

3,78€

BASE / CLAVIJA SCHUKO CON ASA 16A

10 UDS



MTE-0034 - Macho Negro

250v - 16A
IP20

PVPR

2,88€

10 UDS



MTE-0032 - Macho Blanco

250v - 16A
IP20

PVPR

2,88€

10 UDS



MTE-0035 - Hembra Negro

250v - 16A
IP20

PVPR

3,09€

10 UDS



MTE-0033 - Hembra Blanco

250v - 16A
IP20

PVPR

3,09€

BASE / CLAVIJA SCHUKO CON ASA 16A - EXTERIOR

10 UDS



MTE-0045 - Macho Negro

250v - 16A
IP44

PVPR

3,31€

10 UDS



MTE-0046 - Hembra Negro

250v - 16A
IP44

PVPR

4,17€

BASE / CLAVIJA 4mm 10A 250V PROTECCIÓN INFANTIL



	<p>25 UDS</p> <p>MTE-0013 - Hembra Negro</p> <p>250v - 10A IP20 4mm</p>	<p>PVPR 2,07€</p>		<p>25 UDS</p> <p>MTE-0012 - Hembra Blanco</p> <p>250v - 10A IP20 4mm</p>	<p>PVPR 2,07€</p>
	<p>50 UDS</p> <p>MTE-0020 - Macho Negro</p> <p>250v - 10A IP20 4mm</p>	<p>PVPR 1,65€</p>		<p>50 UDS</p> <p>MTE-0019 - Macho Blanco</p> <p>250v - 10A IP20 4mm</p>	<p>PVPR 1,65€</p>

BASE / CLAVIJA SCHUKO PLANA 16A

	<p>25 UDS</p> <p>MTE-0026 - Clavija Schuko macho 4.8mm 16A Marfil</p> <p>250v - 16A IP20 Plana</p>	<p>PVPR 2,31€</p>	
	<p>MTE-0027 - Clavija Schuko macho 4.8mm 16A Negro</p> <p>250v - 16A IP20 Plana</p>	<p>2,31€</p>	

BASE / CLAVIJA SCHUKO AEREA 16A

FACIL
INSTALACIÓN DE
CONEXIÓN

	<p>10 UDS</p> <p>MTE-0037 - Macho Negro</p> <p>250v - 16A IP20</p>	<p>PVPR 3,66€</p>		<p>10 UDS</p> <p>MTE-0036 - Macho Blanco</p> <p>250v - 16A IP20</p>	<p>PVPR 3,66€</p>
	<p>10 UDS</p> <p>MTE-0039 - Hembra Negro</p> <p>250v - 16A IP20</p>	<p>PVPR 4,38€</p>		<p>10 UDS</p> <p>MTE-0038 - Hembra Blanco</p> <p>250v - 16A IP20</p>	<p>PVPR 4,38€</p>



10 UDS

PVPR

MTE-0008 - Toma para horno 25A

7,74€

250v - 25A
2P+E
PP Material
IP20



10 UDS

PVPR

MTE-0014 - Clavija macho para horno 25A

7,02€

250v - 25A
2P+E
PP Material
IP20

ADAPTADOR TOMAS SCHUKO 16A 250V PROTECCIÓN INFANTIL



10 UDS



MTE-0022 - 3 TOMAS

PVPR

250v - 16A
IP20
4.8mm

6,60€



MTE-0023 - 2 TOMAS

PVPR

250v - 16A
IP20
4.8mm

5,85€



MTE-0024 - 2 TOMAS

PVPR

250v - 16A
IP20
4.8mm

4,35€



MTE-0025 - 3 TOMAS

PVPR

250v - 16A
IP20
4.8mm

5,82€

Haz tu instalación
SEGURA en el exterior

IP
44



CLAVIJA SCHUKO GOMA 16A - IMPERMEABLE



10 UDS

MTE-0011 - MACHO NEGRO

PVPR

3,27€

250v - 16A
IP44
Cable 1.5mm²



10 UDS

MTE-0021 - HEMBRA NEGRO

PVPR

4,77€

250v - 16A
IP44
Cable 1.5mm²

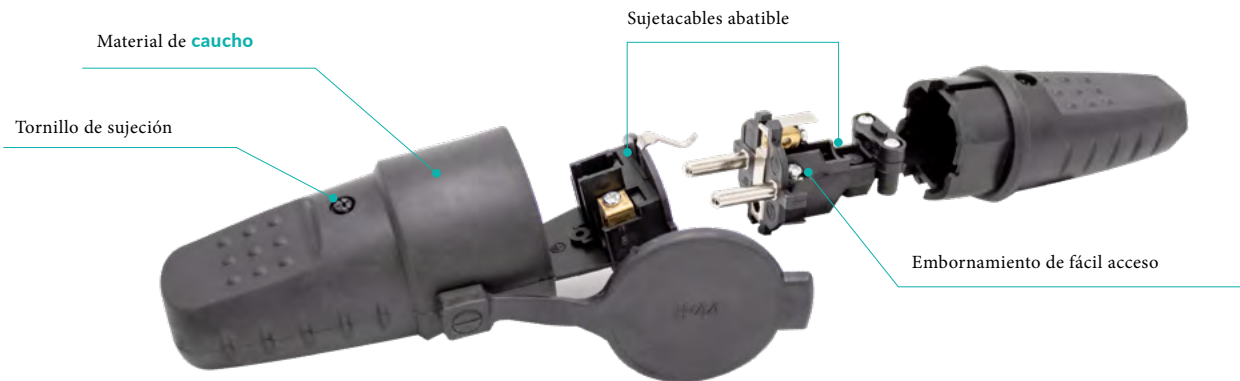

**FACIL
INSTALACIÓN
DE CONEXIÓN**



NEW!

CLAVIJA SCHUKO EXTERIOR GOMA 16A



10 UDS

MTE-0030 - Macho Rojo

PVPR

250v - 16A
IP54

4,80€



10 UDS

MTE-0031 - Hembra Rojo

PVPR

250v - 16A
IP54

6,30€

NEW!

BASE MULTIPLE EXTERIOR 3 TOMAS 16A



1 UDS

MTE-0044 - Hembra Rojo

· Material libre de halógenos

PVPR

· Resistencia al fuego 750°C

14,85€

· Resistencia al calor 70/125°C

· Potencia máx 3680w

· Grado de protección IP44

2P + T

250v - 16A

IP44

Potencia máx 3680w

Material PP

REGLETAS DE CONEXIÓN RÁPIDA

Descripción:

Conecta rápida y fácilmente entre sí todo tipo de cables de diferentes tamaños hasta 4mm².

Cuenta con un orificio de testeo en la parte frontal para un control óptimo de la conectividad.

Puede combinar cables de distintas secciones, rígidos o flexibles, de entre 0,5 y 4 mm²

Conecta los cables de manera
RÁPIDA y FÁCIL



Alta
calidad



Rápido y
seguro



Inflamabilidad
UL94-V2



Seguridad



Para una buena conexión
introducir los cables
hasta el final

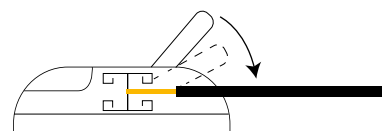

Conexión sin
necesidad de:

Soldar, Cinta adhesiva, Empalmes



Soldar



Cinta adhesiva



Empalmes

Grado de protección

Inflamabilidad: UL94-V2

Materiales

Polycarbonato PC

Todas las regletas tienen un
Diámetro mínimo 0,5mm²



DESCARGAR
FICHA TÉCNICA



		REF	UDS	PVPR
Regleta de conexión rápida	0,5 - 4mm ² 1P	FCH-026	50	20,10 €



0,8cm

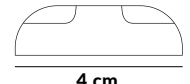

4 cm

1,3 cm



Regleta de conexión rápida	0,5 - 4mm ² 2P	FCH-027	50	20,94 €
----------------------------	---------------------------	---------	----	---------



1,4cm

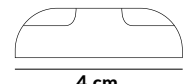

4 cm

1,3 cm



Regleta de conexión rápida	0,5 - 4mm ² 3P	FCH-028	50	32,94 €
----------------------------	---------------------------	---------	----	---------

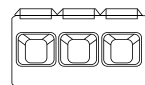

1,8cm

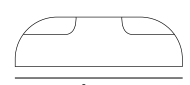

4 cm

1,3 cm

Conector rápido universal



		REF	UDS	PVPR
Conector rápido universal	0,5 - 4mm ² 2P	FCH-029	100	28,20 €

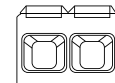

1,4cm

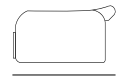

1,8cm

1cm



Conector rápido universal	0,5 - 4mm ² 3P	FCH-030	100	32,88 €
---------------------------	---------------------------	---------	-----	---------

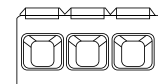

1,8cm

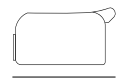

1,8cm

1cm

Conector rápido universal	6mm 3P	FCH-032	50	39,48 €
---------------------------	--------	---------	----	---------

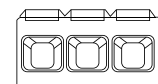

1,8cm

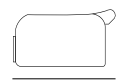

1,8cm

1cm

Conector rápido universal	0,5 - 4mm ² 5P	FCH-031	50	24,60 €
---------------------------	---------------------------	---------	----	---------

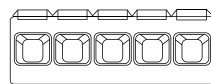

3cm

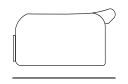

1,8cm

1cm



REGLETAS DE CONEXIÓN

Bornas de conexión fabricadas en polipropileno con propiedades ignífugas, abocardadas en ambos extremos. Están disponibles en color blanco y negro y ofrecen una excelente resistencia mecánica junto con una alta fiabilidad en cuanto a seguridad eléctrica.

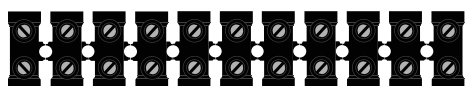
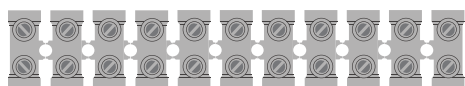

Ideales para simplificar las tareas del profesional eléctrico, cuentan con un diseño que permite separar los polos fácilmente dejando los bordes suaves.

Proporcionan una solución práctica y segura sin necesidad de utilizar herramientas para su corte. Se ofrecen en acabados blanco y negro.

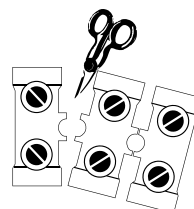
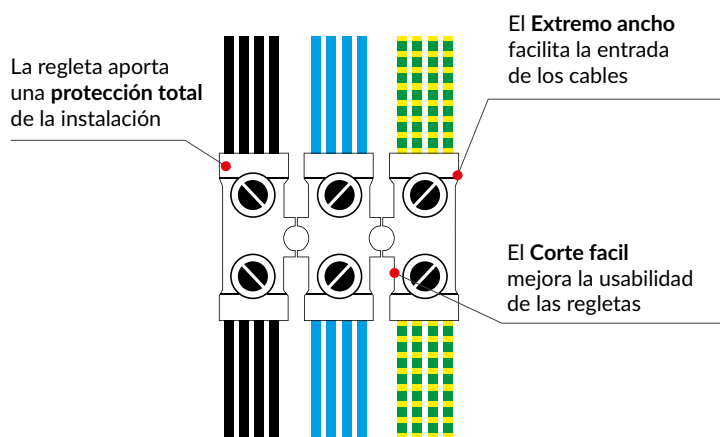

Otras marcas

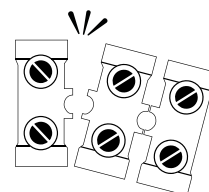

Regleta Atmoss

Corte facil

El **corte es más sencillo** y fácil, sin necesidad de utilizar herramientas de corte. Dejando el borde sin aristas.

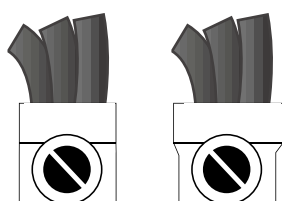

Otras marcas

Regleta Atmoss

Abertura más ancha

Las regletas tienen la **abertura más ancha** para facilitar la entrada de los cables, a diferencia de otras marcas que tienen la entrada más estrecha.



Otras marcas



Regleta Atmoss

Tornillo imperdible

El tornillo no se desprende al desatornillar.

Regletas de conexión

Norma, certificados y materiales

Materiales

Regletas de Polipropileno retardante
 Inserciones de acero.
 Tornillos de acero cincado.
 Temperatura de trabajo
 -40°C a +80°C



EN 60 998-2-1:2004
 2011/65/UE/ROHS



DESCARGAR
 FICHA TÉCNICA

450V

10 UDS en blister plastificado

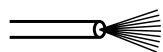

Sección: **6mm²**

500 uds/caja

REF

PVPR

Regleta de conexión para cable eléctrico **6mm²** **Blanco** FCH-006 0,87 €

Regleta de conexión para cable eléctrico **6mm²** **Negro** FCH-006 0,87 €

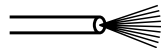

Sección: **10mm²**

300 uds/caja

REF

PVPR

Regleta de conexión para cable eléctrico **10mm²** **Blanco** FCH-0010 1,08 €

Regleta de conexión para cable eléctrico **10mm²** **Negro** FCH-0010 1,08 €

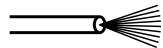

Sección: **16mm²**

200 uds/caja

REF

PVPR

Regleta de conexión para cable eléctrico **16mm²** **Blanco** FCH-0016 2,04 €

Regleta de conexión para cable eléctrico **16mm²** **Negro** FCH-0016 2,04 €

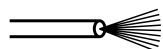

Sección: **25mm²**

100 uds/caja

REF

PVPR

Regleta de conexión para cable eléctrico **25mm²** **Blanco** FCH-0025 3,45 €

Regleta de conexión para cable eléctrico **25mm²** **Negro** FCH-0025 3,45 €

Punteras huecas

AISLADAS EN POLIPROPILENO RETARDANTE

USO PROFESIONAL

Conecta de forma más rápida, segura y sin esfuerzo.

Punteras huecas aisladas en polipropileno retardante.

Nuestras punteras huecas, fabricadas en cobre estañado de alta calidad recubiertas de latón, aseguran una unión fiable en tus instalaciones eléctricas.

Aislamiento: Polipropileno retardante

Temperatura de uso: Máx 105°C

Dimensiones: Según norma DIN 46228T4



Punteras huecas simples



100 UDS en bolsa



DESCARGAR FICHA TÉCNICA

Dimensiones (mm)

Ref	F	L	W	DΦ	CΦ	Sección	Color	PVPR
PHA-001	8.0	14.0	2.6	1.3	1.0	0.5	Blanco	0,58€
PHA-002	6.0	14.6	2.8	1.6	1.3	0.75	Azul	0,75€
PHA-013	6.0	14.6	2.8	1.6	1.3	0.75	Gris	0,75€
PHA-003	8.0	14.6	3.0	1.8	1.5	1.0	Rojo	0,87€
PHA-004	6.0	14.6	3.5	2.1	1.8	1.5	Negro	0,90€
PHA-005	8.0	15.2	4.0	2.6	2.3	2.5	Gris	1,02€
PHA-014	8.0	15.2	4.0	2.6	2.3	2.5	Azul	1,02€
PHA-015	9.0	16.5	4.4	3.2	2.8	4.0	Gris	1,68€
PHA-006	9.0	16.5	4.4	3.2	2.8	4.0	Naranja	1,68€
PHA-016	12.0	20.0	6.3	3.5	3.5	6.0	Amarillo	2,55€
PHA-007	12.0	20.0	6.3	3.5	3.5	6.0	Verde	2,55€
PHA-017	12.0	21.5	7.6	4.9	4.5	10.0	Rojo	3,33€
PHA-008	12.0	21.5	7.6	4.9	4.5	10.0	Marrón	3,33€
PHA-018	12.0	22.2	8.8	6.2	5.8	16.0	Azul	4,35€
PHA-009	12.0	22.2	8.8	6.2	5.8	16.0	Plata	4,35€
PHA-019	16.0	29.0	11.2	7.9	7.5	25.0	Amarillo	8,07€
PHA-010	16.0	29.0	11.2	7.9	7.5	25.0	Negro	8,07€
PHA-011	16.0	30.0	12.7	8.7	8.3	35.0	Rojo	10,95€
PHA-012	20.0	36.0	15.3	10.9	10.3	50.0	Azul	24,36€

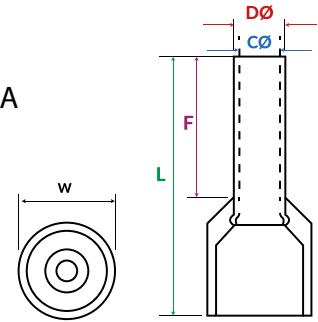

Punteras huecas dobles



100 UDS en bolsa

Dimensiones (mm)

Ref	F	L	W	B	DΦ	CΦ	Sección	Color	PVPR
PHA-201	8	14,5	5	6.5	1.8	1,5	2x0.5	Blanco	1,47€
PHA-202	8	14,7	5,5	6.7	2.1	1.8	2x0.75	Gris	1,57€
PHA-203	8	15,1	5,5	7.1	2.3	2,0	2x1.0	Rojo	1,62€
PHA-204	8	15,5	6,4	7.2	2.6	2,3	2x1.5	Negro	2,58€
PHA-205	10	18,5	8	8.5	3.3	2,9	2x2.5	Azul	3,42€
PHA-206	12	23,1	8,8	11.1	4,2	3,8	2x4.0	Gris	4,62€
PHA-207	14	26,1	9,5	12.1	5,3	4,9	2x6.0	Amarillo	4,98€
PHA-208	14	26,6	12,6	12	6,9	6,5	2x10.0	Rojo	8,37€
PHA-209	14	31,3	19	17.3	8,7	8,3	2x16.0	Azul	11,49€

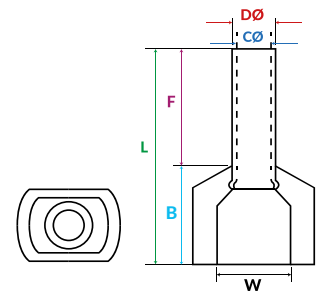

BRIDAS

ALTA RESISTENCIA



Bridas de **NYLON66** resistentes



NEW!



Temperatura de trabajo **-40°C + 85°C**



Mín. temperatura de instalación **20°C**



Grado de inflamabilidad del material **UL94V-2**

Ancho bridas

- | | | | |
|--|--------|--|--------|
| | 2,5 mm | | 6,8 mm |
| | 3,6 mm | | 7,6 mm |
| | 4,8 mm | | |



DESCARGAR FICHA TÉCNICA

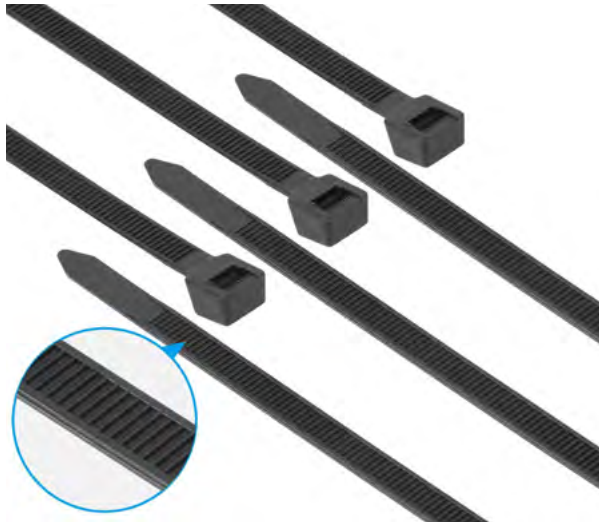

Dientes antideslizantes



Brida blanca



Cierre autoblocante más grueso



Diseño antideslizante



Terminación lisa para facilitar la inserción

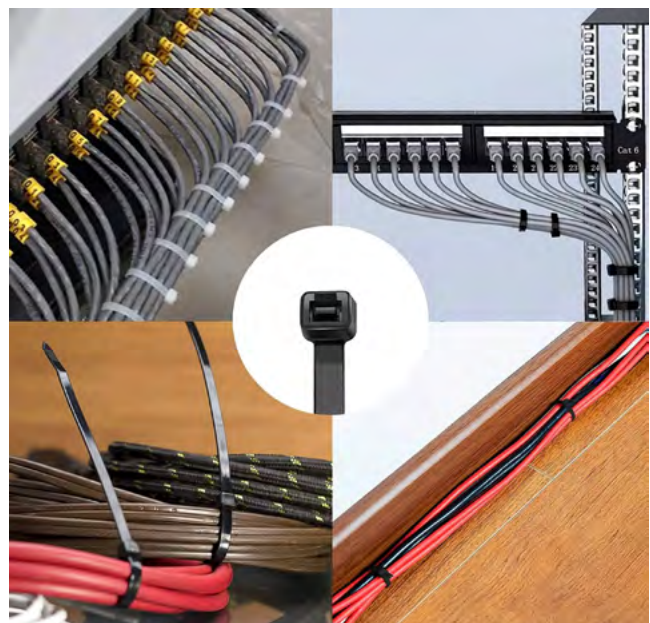

Diferentes modos de uso

NEW!

TACOS A PRESIÓN para fijación de bridas

Los tacos a presión son adecuados para su uso en un amplio rango de materiales como hormigón, ladrillo o madera. Se instalan golpeando sobre el orificio (dependiendo del material). Debido a su amplia cabeza, los manojos de cables pueden colocarse a una distancia del enladrillado mediante el taco.



Temperatura de trabajo
-20°C + 85°C



Mín. temperatura de
instalación 20°C



Grado de inflamabilidad del
material **UL94V-2**



- Buen comportamiento en ambientes húmedos y corrosivos
- Facilidad de montaje
- Perfecta retención de la brida.
- Las aletas flexibles ayudan a fijar y sujetar mejor los tubos, sin dañarlos.

• Para instalaciones de uso interior o exterior

• Ideal para superficies de

- Hormigón.
- Ladrillo macizo
- Forjado
- Ladrillo hueco



100 UDS en bolsa

Material: Poliamida



TACOS A PRESIÓN PARA FIJACIÓN DE BRIDAS CON ALETA
Negro 8mm

Ref

TCDA-001

PVPR

5,16€



TACOS A PRESIÓN PARA FIJACIÓN DE BRIDAS CON ALETA
Gris 8mm

TCDA-002

5,16€



100 UDS en bolsa



Bridas color NEGRO ●

Ref		PVPR		W	L
BDA-001	BRIDA NEGRA 2.5*150mm NYLON66 IGNIFUGO	0,87€		2.5	150 mm
BDA-003	BRIDA NEGRA 3.6*200mm NYLON66 IGNIFUGO	1,83€		3.6	200 mm
BDA-005	BRIDA NEGRA 3.6*250mm NYLON66 IGNIFUGO	2,31€		3.6	250 mm
BDA-007	BRIDA NEGRA 3.6*300mm NYLON66 IGNIFUGO	2,61€		3.6	300 mm
BDA-009	BRIDA NEGRA 3.6*350mm NYLON66 IGNIFUGO	3,15€		3.6	350 mm
BDA-011	BRIDA NEGRA 3.6*500mm NYLON66 IGNIFUGO	5,10€		3.6	500 mm
BDA-015	BRIDA NEGRA 4.8*250mm NYLON66 IGNIFUGO	3,12€		4.8	250 mm
BDA-017	BRIDA NEGRA 4.8*300mm NYLON66 IGNIFUGO	3,57€		4.8	300 mm
BDA-019	BRIDA NEGRA 4.8*350mm NYLON66 IGNIFUGO	4,47€		4.8	350 mm
BDA-021	BRIDA NEGRA 4.8*500mm NYLON66 IGNIFUGO	6,51€		4.8	500 mm
BDA-023	BRIDA NEGRA 6.8*200mm NYLON66 IGNIFUGO	4,62€		6.8	200 mm

Bridas color GRIS ●

Ref		PVPR		W	L
BDA-002	BRIDA GRIS 2.5*150mm NYLON66 IGNIFUGO	0,93€		2.5	150 mm
BDA-004	BRIDA GRIS 3.6*200mm NYLON66 IGNIFUGO	1,95€		3.6	200 mm
BDA-006	BRIDA GRIS 3.6*250mm NYLON66 IGNIFUGO	2,43€		3.6	250 mm
BDA-008	BRIDA GRIS 3.6*300mm NYLON66 IGNIFUGO	2,76€		3.6	300 mm
BDA-010	BRIDA GRIS 3.6*350mm NYLON66 IGNIFUGO	3,33€		3.6	350 mm
BDA-012	BRIDA GRIS 3.6*500mm NYLON66 IGNIFUGO	5,37€		3.6	500 mm
BDA-016	BRIDA GRIS 4.8*250mm NYLON66 IGNIFUGO	3,27€		4.8	250 mm
BDA-018	BRIDA GRIS 4.8*300mm NYLON66 IGNIFUGO	3,75€		4.8	300 mm
BDA-020	BRIDA GRIS 4.8*350mm NYLON66 IGNIFUGO	4,71€		4.8	350 mm
BDA-022	BRIDA GRIS 4.8*500mm NYLON66 IGNIFUGO	6,81€		4.8	500 mm
BDA-024	BRIDA GRIS 6.8*200mm NYLON66 IGNIFUGO	4,86€		6.8	200 mm
BDA-026	BRIDA GRIS 7.6*500mm NYLON66 IGNIFUGO	12,81€		7.6	500 mm



Bridas color **NEGRO ULTRA UV** ● 100 UDS en bolsa

W L

Ref		PVPR		
BDA-106	BRIDA NEGRA 4.8*200mm ULTRA UV NYLON66 IGNIFUGO	3,15€		4.8 * 200 mm
BDA-107	BRIDA NEGRA 4.8*250mm ULTRA UV NYLON66 IGNIFUGO	4,62€		4.8 * 250 mm
BDA-108	BRIDA NEGRA 4.8*300mm ULTRA UV NYLON66 IGNIFUGO	5,28		4.8 * 300 mm
BDA-109	BRIDA NEGRA 4.8*350mm ULTRA UV NYLON66 IGNIFUGO	6,60€		4.8 * 350 mm
BDA-110	BRIDA NEGRA 4.8*500mm ULTRA UV NYLON66 IGNIFUGO	9,36€		4.8 * 500 mm
BDA-112	BRIDA NEGRA 7.6*500mm ULTRA UV NYLON66 IGNIFUGO	18,06€		7.6 * 500 mm

Bridas color **GRIS ULTRA UV** ●

Ref		PVPR		
BDA-119	BRIDA GRIS 4.8*200mm ULTRA UV NYLON66 IGNIFUGO	3,21€		4.8 * 200 mm
BDA-120	BRIDA GRIS 4.8*250mm ULTRA UV NYLON66 IGNIFUGO	4,83€		4.8 * 250 mm
BDA-121	BRIDA GRIS 4.8*300mm ULTRA UV NYLON66 IGNIFUGO	5,55€		4.8 * 300 mm
BDA-122	BRIDA GRIS 4.8*350mm ULTRA UV NYLON66 IGNIFUGO	6,96€		4.8 * 350 mm

Bridas color **BLANCA ULTRA UV** ○

Ref		PVPR		
BDA-027	BRIDA BLANCA 2.5*150mm NYLON66 IGNIFUGO	1,29€		2.5 * 150 mm
BDA-028	BRIDA BLANCA 3.6*200mm NYLON66 IGNIFUGO	2,73 €		3.6 * 200 mm
BDA-029	BRIDA BLANCA 3.6*250mm NYLON66 IGNIFUGO	3,42€		3.6 * 250 mm
BDA-030	BRIDA BLANCA 3.6*300mm NYLON66 IGNIFUGO	3,87€		3.6 * 300 mm
BDA-031	BRIDA BLANCA 3.6*350mm NYLON66 IGNIFUGO	4,68€		3.6 * 350 mm
BDA-032	BRIDA BLANCA 3.6*500mm NYLON66 IGNIFUGO	7,56€		3.6 * 500 mm
BDA-033	BRIDA BLANCA 4.8*200mm NYLON66 IGNIFUGO	3,15€		4.8 * 200 mm
BDA-034	BRIDA BLANCA 4.8*250mm NYLON66 IGNIFUGO	4,62€		4.8 * 250 mm
BDA-035	BRIDA BLANCA 4.8*300mm NYLON66 IGNIFUGO	5,28€		4.8 * 300 mm
BDA-036	BRIDA BLANCA 4.8*350mm NYLON66 IGNIFUGO	6,60€		4.8 * 350 mm
BDA-037	BRIDA BLANCA 4.8*500mm NYLON66 IGNIFUGO	9,63€		4.8 * 500 mm
BDA-038	BRIDA BLANCA 6.8*200mm NYLON66 IGNIFUGO	6,84€		6.8 * 200 mm
BDA-039	BRIDA BLANCA 7.6*500mm NYLON66 IGNIFUGO	18,06€		7.6 * 500 mm

* Según la nueva normativa ERP ha habido un cambio en la medición de Lúmenes y vatios, pero sigue emitiendo la misma cantidad de luz.

A medida que vayan entrando los nuevos modelos con ERP se irá actualizando en catálogo y cajas de color.

Puede haber variación respecto la caja del producto (comprobar en ficha técnica), todos los datos en catálogo están correctos salvo error tipográfico.

Cintas eléctricas

USO PROFESIONAL



20m
x19mm (Ancho)
0,15mm Grosor

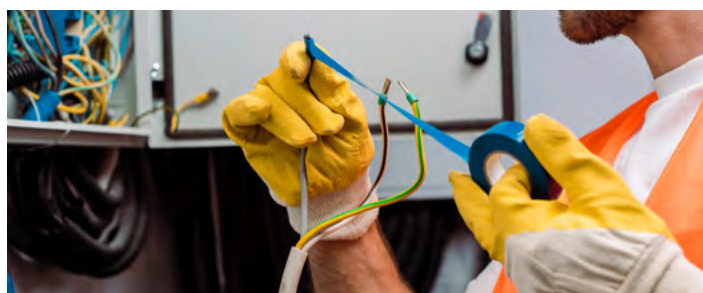
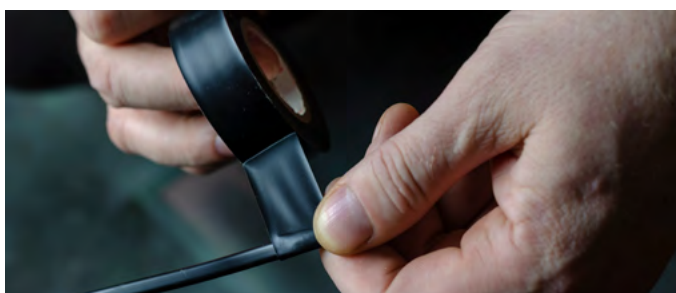

CINTAS ELÉCTRICAS DE PRIMERA CALIDAD PARA AISLAMIENTO ELÉCTRICO

Norma: EN 60454-3-12:2006 NORMA CE 2014/35/EU



CARACTERÍSTICAS

- Alta flexibilidad.
- Alta resistencia a la rotura.
- Alta recuperación de elasticidad
- Ignífugo

10 UDS en blister plastificado

- Buena protección mecánica y eléctrica
- Aislamiento de hilos y cables eléctricos hasta 600v, 80°C
- Espesor 0,15mm
- Composición, cinta de PVC con adhesivo de caucho

DESCARGAR
FICHA TÉCNICA

Medidas 20m | 19mm | 0,15mm
19mm



SE VENDE EN PAQUETE DE 10UDS - PRECIO UNITARIO	10 UDS	Ref	PVPR
CINTA AISLANTE PVC IGNÍFUGO NEGRO		CIN-001	1,44€



SE VENDE EN PAQUETE DE 10UDS - PRECIO UNITARIO	10 UDS	Ref	PVPR
CINTA AISLANTE PVC IGNÍFUGO AZUL		CIN-002	1,44€



SE VENDE EN PAQUETE DE 10UDS - PRECIO UNITARIO



Ref

PVPR

CINTA AISLANTE PVC IGNÍFUGO

AMARILLO-VERDE

CIN-003

1,44€



SE VENDE EN PAQUETE DE 10UDS - PRECIO UNITARIO



Ref

PVPR

CINTA AISLANTE PVC IGNÍFUGO

BLANCO

CIN-004

1,44€



SE VENDE EN PAQUETE DE 10UDS - PRECIO UNITARIO

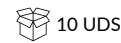

Ref

PVPR

CINTA AISLANTE PVC IGNÍFUGO

VERDE

CIN-005

1,44€



SE VENDE EN PAQUETE DE 10UDS - PRECIO UNITARIO

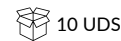

Ref

PVPR

CINTA AISLANTE PVC IGNÍFUGO

GRIS

CIN-006

1,44€



SE VENDE EN PAQUETE DE 10UDS - PRECIO UNITARIO

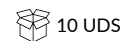

Ref

PVPR

CINTA AISLANTE PVC IGNÍFUGO

ROJO

CIN-007

1,44€



SE VENDE EN PAQUETE DE 10UDS - PRECIO UNITARIO

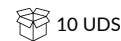

Ref

PVPR

CINTA AISLANTE PVC IGNÍFUGO

AMARILLO

CIN-008

1,44€

NEW!



SE VENDE EN PAQUETE DE 10UDS - PRECIO UNITARIO

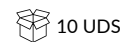

Ref

PVPR

CINTA AISLANTE PVC IGNÍFUGO

MARRÓN

CIN-009

1,44€



SERIE FUERZA

ATMOSS LIGHTING
CINTA VULCANIZADA AUTOSOLDABLE
IGNÍFUGO - CIN-100 - NEGRO
 9.15m
 19mm (Ancho)
 76mm Grosor

**CINTA VULCANIZADA
 AUTOSOLDABLE
 IGNÍFUGO - CIN-100**



CINTA VULCANIZADA AUTOSOLDABLE NEGRO 19mm x 9,15m

Ref

PVPR

CIN-100

5,76€

• Atiende a norma:
EN 60454-3-12:2006
NORMA CE 2014/35/EU

9.15m
x19mm (Ancho)
0.76mm Grosor

- Rigidez dieléctrica 20 kV
- Composición: Cinta de PVC con adhesivo de caucho
- Espesor: 0.76mm
- Medidas: 0,76mm*19mm*9,15m



Series **Reloj temporizador**
Interior IP20

Reloj temporizador mecánico



RLJ-015

Reloj temporizador
mecánico blanco

PVPR 10,29 €

1 UDS



RLJ-016

Reloj temporizador mecánico
mini blanco

PVPR 10,35 €

1 UDS



Reloj temporizador digital

NEW!



RLJ-019

Reloj temporizador digital blanco

PVPR 20,94 €

1 UDS



RLJ-011

Reloj temporizador semanal digital

PVPR 28,59 €

1 UDS

DESCARGAR

VIDEO



Reloj temporizador exterior IP44

NEW!



RLJ-018

Reloj temporizador 24h digital exterior IP44

PVPR 22,44 €

1 UDS



NEW!



RLJ-017

Reloj temporizador mecánico blanco exterior IP44

PVPR 13,14 €

1 UDS



Serie Portalámparas E27



NEW!

PORTALÁMPARA E27

BLANCO

Ref
PORTLM-004

PVPR
0,78€

PORTALÁMPARA E27

NEGRO

Ref
PORTLM-005

PVPR
0,78€



Max. 4 lámparas de 30W

PORTALÁMPARAS

4xE27 - E40

Ref

PVPR

ACLED-010

22,77€

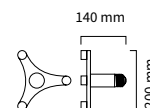

PORTALAMPARA REDUCTOR

E40 A E27

Ref

PVPR

PORTLM-003

2,70€



NEW!



PORTALÁMPARA E27 INCLINADO

BLANCO

Ref

PVPR

MTE-0042

2,19€

NEW!



PORTALÁMPARA E27 RECTO

BLANCO

Ref

PVPR

MTE-0043

2,19€

Extractores aseo



Ultra silencioso - Ø100mm

Ref PVPR

EXTRACTOR SILENT VACUUM V-1 BLANCO 4" 15W 180m³/h 36dB EXT-001 21,51€

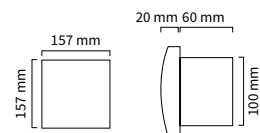

Ultra silencioso - Ø100mm

ANTI-RETORNO OLORES

EXTRACTOR SILENT VACUUM V-2 BLANCO 4" 15W 70m³/h 30dB EXT-002 58,38€

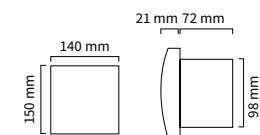

Ultra silencioso - Ø100mm

ANTI-RETORNO OLORES

EXTRACTOR SILENT VACUUM V-3 BLANCO 4" 12W 95m³/h 34dB EXT-003 41,52€

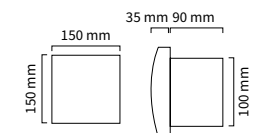

CON TEMPORIZADOR



Ultra silencioso - Ø100mm - CON TEMPORIZADOR 1-25MIN ANTI-RETORNO OLORES

EXTRACTOR SILENT VACUUM V-4 12W 70m³/h 30dB EXT-004 87,06€

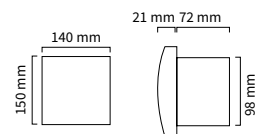

CON TEMPORIZADOR



Ultra silencioso - Ø102mm - CON TEMPORIZADOR 1-30MIN ANTI-RETORNO OLORES

EXTRACTOR SILENT VACUUM V-5 12W 66m³/h 39dB EXT-005 52,35€

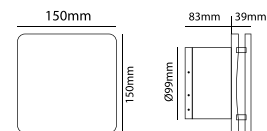



Serie Secadores



70-80db



SECADO RÁPIDO Y SILENCIOSO

Ref

PVPR

SECAMANOS

850W

SEC-001

47,88 €



Temp del aire: 38°C ± 15°C



Distancia detección: >50mm

Tiempo: < 5sec



70-80db



SECADO RÁPIDO Y SILENCIOSO

SECAMANOS BLANCO

1200W

SEC-002

105,30 €



Temp del aire: 60°C ± 20°C



Velocidad de viento: >30m/seg

Distancia de actuación: >140mm

Tiempo: <12sec



Botón cambio
aire frío / caliente

Luz LED indicador
aire caliente/frío

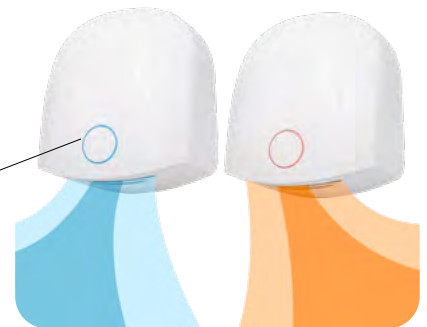

70-80db



SECADO RÁPIDO Y SILENCIOSO

SECAMANOS NEGRO

1200W

SEC-003

116,70 €



Temp del aire: 60°C ± 20°C



Velocidad de viento: >30m/seg

Distancia de actuación: >140mm

Tiempo: <12sec



Serie extractores cocina

NEW!



Diametro tubo - Ø100mm



EXTRACTOR COCINA SILENT

70W 288m³/h 65dB

Ref

PVPR

EXT-006

169,56 €

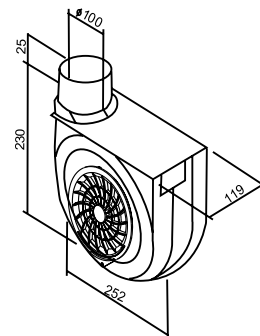

NEW!



Diametro tubo - Ø95mm



EXTRACTOR COCINA SILENT

85W 210m³/h 65dB

Ref

PVPR

EXT-007

173,40 €

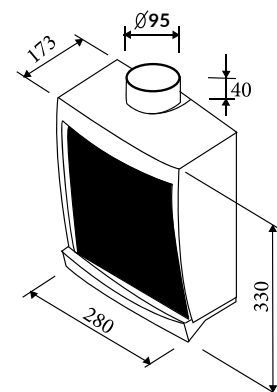

* Según la nueva normativa ERP ha habido un cambio en la medición de Lúmenes y vatios, pero sigue emitiendo la misma cantidad de luz. A medida que vayan entrando los nuevos modelos con ERP se irá actualizando en catálogo y cajas de color. Puede haber variación respecto la caja del producto (comprobar en ficha técnica), todos los datos en catálogo están correctos salvo error tipográfico.



Serie Ventilador



Disponible control remoto

DC MOTOR
ULTRA-SILENCE



3 en 1 TRES TIPOS DE LUZ
EN LA MISMA LUMINARIA

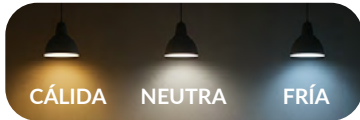

2 Modos

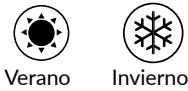

	Ref	PVPR
VENTILADOR CON LED 3 Aspas 42w 6 Modos	VNT-001	98,85 €

42w 3200 Lm 230V 1 IP 20 3CCT

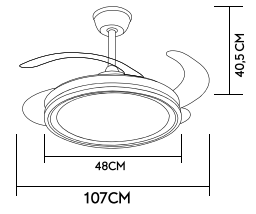

2 Modos

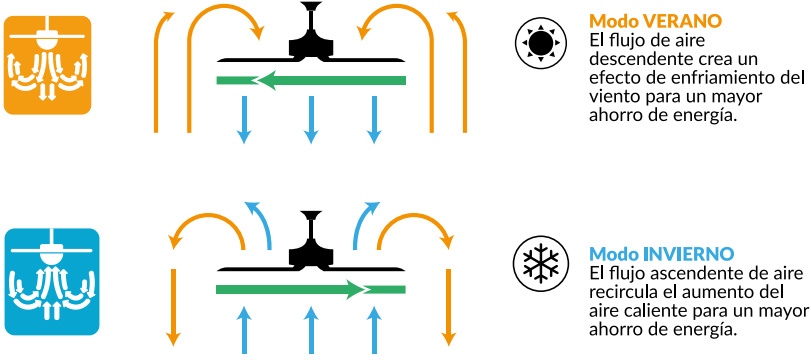

VELOCIDAD	1	2	3	4	5	6
POTENCIA	7W	10W	14W	19W	23W	30W
RPM	180	190	205	215	225	236
FLUJO AIRE	5280m ³ /h	5760m ³ /h	6300m ³ /h	7080m ³ /h	7920m ³ /h	10140m ³ /h
NIVEL SONIDO	20	23	25	27	30	33



ATMOSS
ELECTRIC



MATERIAL
ELÉCTRICO

AHORRA ESPACIO, hasta un 50% más en tú instalación
con los nuevos modelos de espacio reducido

SERIE REDUCIDA

EJEMPLO DE INSTALACIÓN DE VIVIENDA DE 50 A 20CM

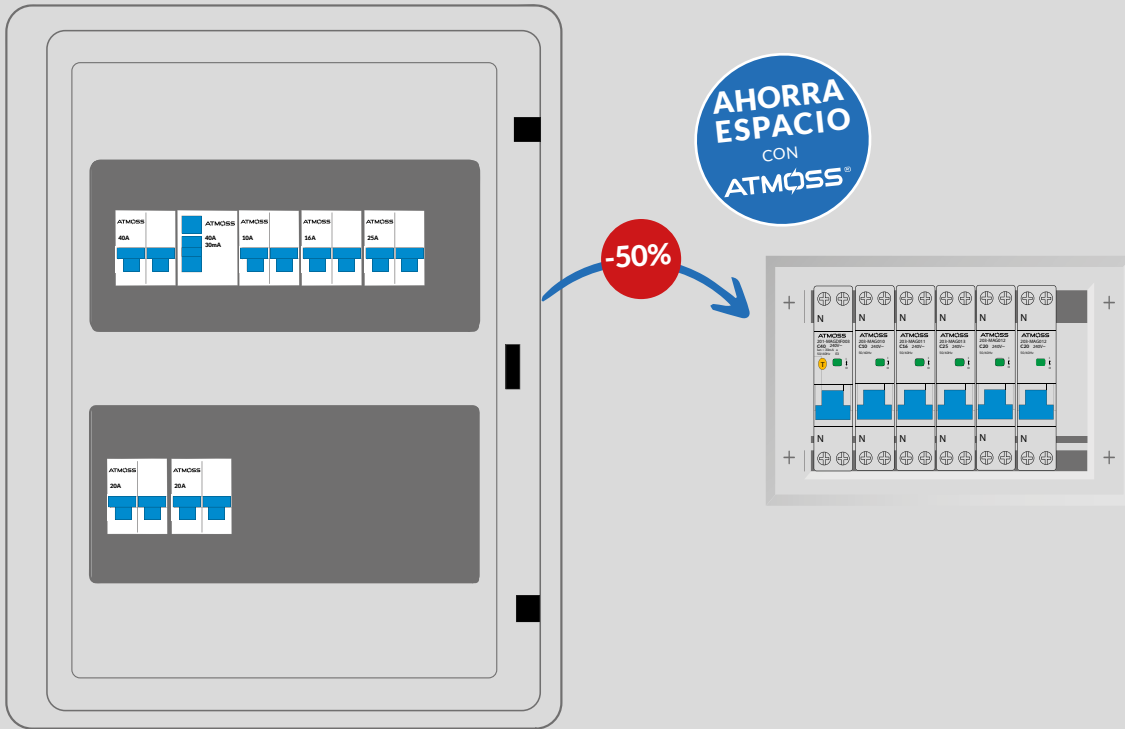

Ejemplo de instalación de vivienda:



MAGNETOTÉRMICO GENERAL
2P 40A - 6kA - Curva C
200-MAG028 **NEW!**



Magnetotérmico general + Diferencial
1P+N 40A - 6kA 30mA Curva C
201-MAGDIF003



DIFERENCIAL
2P 40A - 6kA - TIPO AC
200-DIF011

PEQUEÑO INTERRUPTOR AUTOMÁTICO PIAS



200-MAG023 -10A
200-MAG024 -16A
200-MAG026 -25A
200-MAG025 -20A

NEW!



203-MAG010 -10A
203-MAG011 -16A
203-MAG013 -25A
203-MAG012 -20A

DIFERENCIALES

6KA /10KA /SUPERINMUNIZADO

Protección residencial

¡ La **SEGURIDAD** de las personas garantizada !



NEW PRICE!!

2 POLOS - 6kA - TIPO AC 1 UDS

REF		PVPR
200-DIF010	25A 6kA 30mA	23,70 €
200-DIF011	40A 6kA 30mA	23,70 €
200-DIF012	63A 6kA 30mA	40,77 €

2 POLOS - 10kA - TIPO AC 1 UDS

REF		PVPR
100-DIF0036	40A 10kA 30mA	47,37 €

4 POLOS - 6kA - TIPO AC 1 UDS

REF		PVPR
200-DIF018	25A 6kA 30mA	46,08 €
200-DIF019	40A 6kA 30mA	46,08 €
200-DIF020	63A 6kA 30mA	47,37 €

200-DIF021	25A 6kA 300mA	46,08 €
200-DIF022	40A 6kA 300mA	46,08 €
200-DIF023	63A 6kA 300mA	47,37 €

4 POLOS - 10kA - TIPO AC 3 UDS

REF		PVPR
102-DIF0010	25A 10kA 30mA	51,96 €
102-DIF0011	40A 10kA 30mA	51,96 €
102-DIF0012	63A 10kA 30mA	51,96 €
102-DIF0007	80A 10kA 30mA	67,98 €
102-DIF0008	100A 10kA 30mA	74,79 €

101-DIF000001	25A 10kA 300mA	51,78 €
101-DIF000003	63A 10kA 300mA	57,93 €
101-DIF000004	80A 10kA 300mA	67,98 €
101-DIF000005	100A 10kA 300mA	74,79 €



Evita los cortes intempestivos
MAYOR SENSIBILIDAD 

Diferencial
Superinmunizados



2 POLOS - 6kA - TIPO A   1 UDS 

REF		PVPR
200-DIF027	16A 6kA 30mA	42,90 €
200-DIF016	40A 6kA 30mA	46,08 €
200-DIF028	63A 6kA 30mA	50,46 €
200-DIF017	40A 6kA 300mA	46,08 €



2 POLOS - 10kA - TIPO A   1 UDS 

100-DIF023	80A 10kA 30mA	68,13 €
100-DIF025	100A 10kA 30mA	81,78 €
100-DIF018	63A 10kA 300mA	67,98 €
100-DIF024	80A 10kA 300mA	68,13 €
100-DIF026	100A 10kA 300mA	81,78 €

4 POLOS - 6kA - TIPO A   1 UDS 

200-DIF024	40A 6kA 30mA	59,07 €
200-DIF026	63A 6kA 30mA	67,98 €
200-DIF025	40A 6kA 300mA	59,07 €
200-DIF029	63A 6kA 300mA	63,48 €



4 POLOS - 10kA - TIPO A   1 UDS 

100-DIF019	80A 10kA 30mA	74,40 €
100-DIF021	100A 10kA 30mA	81,78 €
100-DIF037	125A 10kA 30mA	144,36 €
100-DIF015	63A 10kA 300mA	67,98 €
100-DIF020	80A 10kA 300mA	74,40 €
100-DIF022	100A 10kA 300mA	81,78 €
100-DIF038	125A 10kA 300mA	144,36 €

Funcionamiento del diferencial



El indicador siempre estará en blanco, salvo cuando detecta una fuga de corriente residual.

Todos nuestros diferenciales, vienen marcados por normativa en la maneta con ON - OFF

Para ver el funcionamiento clickar sobre la flecha azul



El diferencial se dispara cuando detecta una fuga de corriente residual y aparece el indicador en rojo como se muestra en la imagen.

Cuando se pulsa el boton Test **T** se puede comprobar la fuga de corriente y el indicador se muestra en rojo.



Protección residencial

¡ La **SEGURIDAD** de las personas garantizada !

Protección residencial

¡ Tu HOGAR o FÁBRICA mejor protegido !

DIFERENCIALES SUPER-INMUNIZADO SI

NEW!



· Superinmunizado SI 2P

2 POLOS - 10kA - TIPO A SI   1 UDS

103-DIF001	40A	10kA	30mA	62,55 €	
103-DIF002	40A	10kA	300mA	62,55 €	

NEW!



· Superinmunizado SI 4P

4 POLOS - 10kA - TIPO A SI   1 UDS

103-DIF003	40A	10kA	30mA	73,80 €	
103-DIF004	40A	10kA	300mA	73,80 €	

DIFERENCIAL TIPO F-SI

TIPO-F



Corriente residual alterna hasta 1kHz y pulsante

Alta Frecuencia

NEW!



· Superinmunizado F-SI 2P

2 POLOS - 10kA - TIPO F-SI  1 UDS

105-DIF001	40A	10kA	30mA	67,11 €	
------------	-----	------	------	---------	---

DIFERENCIALES REARMABLES

REARMABLE / SUPERINMUNIZADO REARMABLE



· Rearmable superinmunizado 2P

2 POLOS - 6kA - TIPO A   1 UDS 

100-DIF031 40A 6kA 300mA 193,62 €

2 POLOS - 10kA - TIPO A 

100-DIF040 40A 10kA 30mA 193,62 €

100-DIF027 40A 10kA 300mA 193,62 €



· Rearmable superinmunizado 4P 

4 POLOS - 10kA - TIPO A 

100-DIF028 40A 10kA 300mA 206,70 €

100-DIF041 40A 10kA 30mA 206,70 €



· Diferencial Rearmable 4P 10kA

4 POLOS - 10kA - TIPO AC   1 UDS 

100-DIF009 40A 10kA 30mA 306,63 €



INTERRUPTORES MAGNETOTÉRMICOS

Especial **SERIE - 6kA**

Protección residencial



¡Tu HOGAR o FÁBRICA
mejor protegido!



1 POLO - 6kA - Curva C  12 UDS 

REF		PVPR
200-MAG021	6A 6kA	6,45 €
200-MAG018	10A 6kA	4,44 €





1P+N - 6kA - Curva C  6 UDS 

REF		PVPR
200-MAG001	6A 6kA	5,43 €
200-MAG004	20A 6kA	5,43 €
200-MAG005	32A 6kA	5,43 €
200-MAG006	40A 6kA	6,15 €
200-MAG007	50A 6kA	6,15 €
200-MAG008	63A 6kA	6,15 €

2P - 6kA - Curva C  6 UDS

REF		PVPR
200-MAG022	6A 6kA	6,45 €
200-MAG023	10A 6kA	6,45 €
200-MAG024	16A 6kA	6,45 €
200-MAG025	20A 6kA	6,45 €
200-MAG026	25A 6kA	6,45 €
200-MAG027	32A 6kA	6,96 €
200-MAG028	40A 6kA	7,62 €
200-MAG029	50A 6kA	9,39 €
200-MAG030	63A 6kA	9,39 €



4P - 6kA - Curva C  3 UDS 

REF		PVPR
200-MAG010	6A 6kA	20,28 €
200-MAG011	10A 6kA	20,28 €
200-MAG012	16A 6kA	20,28 €
200-MAG013	20A 6kA	20,28 €
200-MAG019	25A 6kA	20,28 €
200-MAG014	32A 6kA	20,28 €
200-MAG015	40A 6kA	20,28 €
200-MAG016	50A 6kA	20,28 €
200-MAG017	63A 6kA	20,28 €

INTERRUPTORES MAGNETOTÉRMICOS

Especial **SERIE - 10kA**



2P - 10kA - Curva C

 6 UDS 

REF			PVPR
I08-MAG001	10A	10kA	11,82 €
I08-MAG002	16A	10kA	11,82 €
I08-MAG003	20A	10kA	11,82 €
I08-MAG004	25A	10kA	11,82 €
I08-MAG005	32A	10kA	11,82 €
I08-MAG006	40A	10kA	11,82 €
I08-MAG007	50A	10kA	13,44 €
I08-MAG008	63A	10kA	16,89 €



4P - 10kA - Curva C

 3 UDS 

REF			PVPR
I09-MAG001	10A	10kA	29,94 €
I09-MAG002	16A	10kA	29,94 €
I09-MAG003	20A	10kA	29,94 €
I09-MAG004	25A	10kA	29,94 €
I09-MAG005	32A	10kA	29,94 €
I09-MAG006	40A	10kA	32,43 €
I09-MAG007	50A	10kA	32,43 €
I09-MAG008	63A	10kA	32,43 €
I09-MAG010	80A	10kA	60,48 €
I09-MAG011	100A	10kA	63,09 €
I09-MAG012	125A	10kA	63,09 €

La gama 108/109-MAG es compatible con la bobina de tensión **100-BOB004**

VER MÁS
Bobina de tensión
Pág.400



Protección industria

¡ Tu **FÁBRICA**
con mejor seguridad !

INTERRUPTORES MAGNETOTÉRMICOS

Especial **SERIE - 10kA**

Protección industria

¡ Tu **FÁBRICA**
con mejor seguridad !

1 POLO - 10kA - Curva C

 12 UDS



REF		PVPR
100-MAG0016	6A 10kA	6,75 €
100-MAG0007	10A 10kA	6,75 €
100-MAG0008	16A 10kA	6,75 €
100-MAG0009	20A 10kA	6,75 €
100-MAG0010	25A 10kA	6,75 €
100-MAG0011	32A 10kA	6,75 €
100-MAG0012	40A 10kA	6,75 €
100-MAG0019	63A 10kA	8,55 €

COMPATIBLE CON 100-BOB001/003

2 POLOS - 10kA - Curva C

 6 UDS



REF		PVPR
100-MAG0013	6A 10kA	11,82 €
100-MAG0001	10A 10kA	11,82 €
100-MAG0002	16A 10kA	11,82 €
100-MAG0003	20A 10kA	11,82 €
100-MAG0004	25A 10kA	11,82 €
100-MAG0005	32A 10kA	11,82 €
100-MAG0006	40A 10kA	11,82 €
100-MAG0017	50A 10kA	13,44 €
100-MAG0018	63A 10kA	16,89 €

COMPATIBLE CON 100-BOB001/003

3 POLOS - 10kA - Curva C

 4 UDS



REF		PVPR
000-MAG0001	10A 10kA	24,54 €
000-MAG0002	16A 10kA	24,54 €
000-MAG0008	20A 10kA	24,54 €
000-MAG0003	25A 10kA	24,54 €
000-MAG0004	32A 10kA	24,54 €
000-MAG0005	40A 10kA	24,54 €
000-MAG0006	50A 10kA	24,54 €
000-MAG0007	63A 10kA	24,54 €

COMPATIBLE CON 100-BOB001/003

3 POLOS - 10kA - Curva D

 4 UDS



REF		PVPR
000-MAG0027	10A 10kA	33,90 €
000-MAG0028	16A 10kA	33,90 €
000-MAG0029	20A 10kA	33,90 €
000-MAG0030	25A 10kA	33,90 €
000-MAG0031	32A 10kA	33,90 €
000-MAG0032	40A 10kA	33,90 €
000-MAG0033	50A 10kA	33,90 €
000-MAG0034	63A 10kA	33,90 €

COMPATIBLE CON 100-BOB001/003

INTERRUPTORES MAGNETOTÉRMICOS

Especial **SERIE - 10kA**





4 POLOS - 10kA - Curva C  3 UDS 

REF		PVPR
I01-MAG0009	6A 10kA	30,00 €
I01-MAG0001	10A 10kA	30,00 €
I01-MAG0002	16A 10kA	30,00 €
I01-MAG0003	20A 10kA	30,00 €
I01-MAG0004	25A 10kA	30,00 €
I01-MAG0005	32A 10kA	30,00 €
I01-MAG0006	40A 10kA	30,00 €
I01-MAG0007	50A 10kA	30,00 €
I01-MAG0008	63A 10kA	30,00 €

COMPATIBLE CON 100-BOB001/003



4 POLOS - 10kA - Curva D  3 UDS 

REF		PVPR
I04-MAG0018	10A 10kA	33,90 €
I04-MAG0019	16A 10kA	33,90 €
I04-MAG0020	20A 10kA	33,90 €
I04-MAG0021	25A 10kA	33,90 €
I04-MAG0022	32A 10kA	37,50 €
I04-MAG0023	40A 10kA	37,50 €
I04-MAG0024	50A 10kA	37,50 €
I04-MAG0025	63A 10kA	37,50 €
I04-MAG0026	100A 10kA	37,50 €

COMPATIBLE CON 100-BOB001/003

Especial **SERIE - 15kA**



4 POLOS - 15kA - Curva C  3 UDS 

REF		PVPR
I01-MAG0010	80A 15kA	140,37 €
I01-MAG0011	100A 15kA	157,92 €
I01-MAG0012	125A 15kA	175,47 €

NO COMPATIBLE CON 100-BOB001/003

Compatible con:

La gama de 10kA 100-BOB001
100-000-101-104 100-BOB003

VER MÁS
Bobina de tensión
Pág.400



Protección industria

¡ Tu **FÁBRICA**
con mejor seguridad!

* Según la nueva normativa ERP ha habido un cambio en la medición de Lúmenes y vatios, pero sigue emitiendo la misma cantidad de luz. A medida que vayan entrando los nuevos modelos con ERP se irá actualizando en catálogo y cajas de color. Puede haber variación respecto la caja del producto (comprobar en ficha técnica), todos los datos en catálogo estan correctos salvo error tipográfico.

AHORRA ESPACIO, hasta un 50% más en tú instalación

con los nuevos modelos de espacio reducido

SERIE REDUCIDA

EJEMPLO DE INSTALACIÓN DE VIVIENDA DE 50 A 20CM

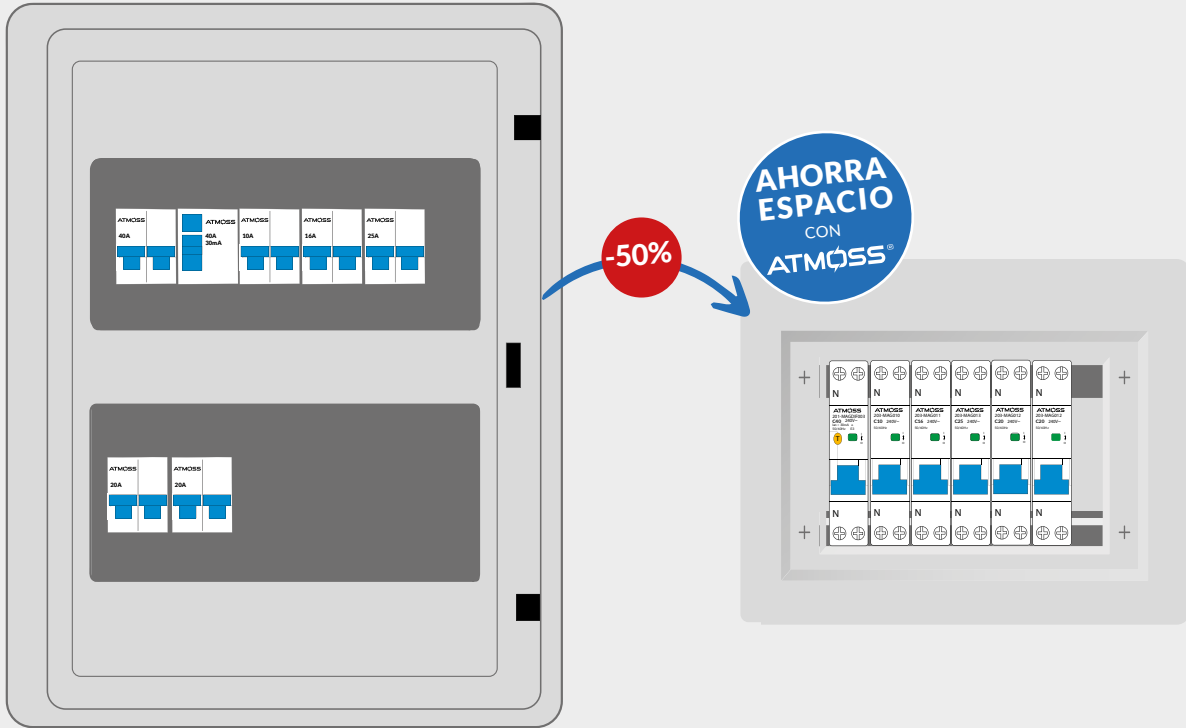

Ejemplo de instalación de vivienda:



MAGNETOTÉRMICO GENERAL
2P 40A - 6kA - Curva C
200-MAG028



NEW!
Magnetotérmico general + Diferencial
1P+N 40A - 6kA 30mA Curva C
201-MAGDIF003



DIFERENCIAL
2P 40A - 6kA - TIPO AC
200-DIF011

PEQUEÑO INTERRUPTOR AUTOMÁTICO PIAS



- 200-MAG023 - 10A
- 200-MAG024 - 16A
- 200-MAG026 - 25A
- 200-MAG025 - 20A



- NEW!** 203-MAG010 - 10A
- 203-MAG011 - 16A
- 203-MAG013 - 25A
- 203-MAG012 - 20A

Protectores para espacio reducido

Interruptores automáticos compactos.

Esta serie de interruptores compactos se presenta en las siguientes combinaciones de polos 1P+N en 1 módulos, 2P en 1 módulo, 3P y 4P en 2 módulos; con un poder de corte que va desde los 6 hasta los 10kA. Estas características le permiten cubrir aplicaciones tanto residenciales como industriales.

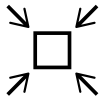

Solución compacta



Fácil de instalar

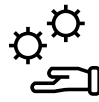

Versátil

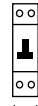

18mm

MAGNETOTÉRMICOS 2P REDUCIDOS



1P+N - 6kA DPN Curva C

 12 UDS

**2POLOS EN
1 MÓDULO**

REF

PVPR

103-MAG007	6A DPN 6kA	10,05 €
103-MAG001	10A DPN 6kA	10,05 €
103-MAG002	16A DPN 6kA	10,05 €
103-MAG003	20A DPN 6kA	10,05 €
103-MAG004	25A DPN 6kA	10,05 €
103-MAG005	32A DPN 6kA	10,89 €
103-MAG006	40A DPN 6kA	10,89 €

DISEÑO Y FORMATO PARA LA GAMA DE 10kA

COMPATIBLE CON 100-BOB001/003



1P+N - 6kA DPN SET - Curva C

 12 UDS

**2POLOS EN
1 MÓDULO**

REF

PVPR

203-MAG010	10A DPN SET 6kA	10,05 €
203-MAG011	16A DPN SET 6kA	10,05 €
203-MAG012	20A DPN SET 6kA	10,05 €
203-MAG013	25A DPN SET 6kA	10,05 €
203-MAG014	32A DPN SET 6kA	10,89 €
203-MAG015	40A DPN SET 6kA	10,89 €

DISEÑO Y FORMATO PARA LA GAMA DE 6kA

MAGNETOTÉRMICOS 4P REDUCIDOS



4P - 6kA - Curva C

 6 UDS

**4POLOS EN
2 MÓDULOS**

REF

PVPR

200-MAG031	10A 6kA	86,94 €
200-MAG032	16A 6kA	86,94 €
200-MAG033	20A 6kA	86,94 €
200-MAG034	25A 6kA	86,94 €
200-MAG035	32A 6kA	86,94 €
200-MAG036	40A 6kA	86,94 €



DIFERENCIALES REDUCIDO



2POLOS EN
1 MÓDULO

 1 UDS



Diferencial Superinmunizado Tipo A 

IP + N - Tipo A

REF				PVPR
I00-DIF042	25A	10kA	10mA	34,77 €
I00-DIF034	40A	10kA	30mA	50,58 €



4POLOS EN
2 MÓDULOS

 1 UDS



Diferencial Superinmunizado Tipo A 

3P + N - Tipo A - 2MÓDULOS

REF				PVPR
I00-DIF035	40A	10kA	30mA	125,61 €
I04-DIF001	40A	10kA	300mA	81,75 €

* Con enclavamiento para candado.

DIFERENCIALES REDUCIDO

2 MÓDULOS



Magneto Diferencial Superinmunizado Tipo A 

IP+N - 10kA 30mA - Curva C

REF			PVPR
I01-MGDIF0008	10A	10kA	67,20 €
I01-MGDIF0009	16A	10kA	67,20 €
I01-MGDIF0010	25A	10kA	67,20 €

2 MÓDULOS



Magneto Diferencial Tipo AC 

2P - 30mA - Curva C 

REF			PVPR
I01-MGDIF0002	16A	30mA	52,47 €
I01-MGDIF0003	20A	30mA	52,47 €
I01-MGDIF0004	25A	30mA	52,47 €
I01-MGDIF0007	32A	30mA	52,47 €
I01-MGDIF0006	40A	30mA	55,98 €

**2POLOS EN
1 MÓDULO**



Magneto Diferencial Superinmunizado Tipo A 

IP+N - 6kA 30mA - Curva C

REF		PVPR
201-MGDIF001	16A 6kA	42,90 €
201-MGDIF002	25A 6kA	42,90 €
201-MGDIF003	40A 6kA	47,58 €

IP+N - 6kA 10mA

REF		PVPR
100-DIF039	16A 6kA 10mA	53,40 €

Electromagnético - Función AFDD



Magneto Diferencial Superinmunizado Tipo A 

301-MGDIF000 10A 6kA 10mA 62,55 €

IP+N - 6kA 30mA - Curva C

301-MGDIF001	10A 6kA	62,55 €
301-MGDIF002	16A 6kA	62,55 €
301-MGDIF003	20A 6kA	62,55 €
301-MGDIF004	25A 6kA	62,55 €
301-MGDIF005	32A 6kA	62,55 €
301-MGDIF006	40A 6kA	62,55 €

IP+N - 6kA 300mA - Curva C

301-MGDIF007	10A 6kA	
301-MGDIF008	16A 6kA	62,55 €
301-MGDIF009	20A 6kA	
301-MGDIF010	25A 6kA	
301-MGDIF011	32A 6kA	
301-MGDIF012	40A 6kA	62,55 €



• **Descripción**

Un Dispositivo de **Detección de Fallos de Arco Eléctrico (AFDD)** es un equipo avanzado diseñado para identificar arcos eléctricos defectuosos en los circuitos y desconectar la parte afectada, previniendo potenciales incendios. Estos arcos pueden originarse por conexiones sueltas, cables dañados o aislamiento defectuoso, representando un riesgo significativo de incendio.

• **Características:**

- **Protección integral:** Combina protección contra fallos de arco eléctrico, cortocircuitos, sobrecargas y corrientes residuales en un solo dispositivo.
- **Detección sensible:** Utiliza tecnología digital avanzada para identificar fallos de arco con alta precisión, superando las directrices aplicables y evitando disparos involuntarios.
- **Indicadores de estado:** Incorpora LEDs que muestran el estado del dispositivo y el motivo del disparo, facilitando la resolución de problemas.
- **Fácil instalación:** Compatible con peines de conexión, permite una instalación sencilla y flexible en sistemas nuevos o existentes.

* Según la nueva normativa ERP ha habido un cambio en la medición de Lúmenes y vatios, pero sigue emitiendo la misma cantidad de luz. A medida que vayan entrando los nuevos modelos con ERP se irá actualizando en catálogo y cajas de color. Puede haber variación respecto a la caja del producto (comprobar en ficha técnica), todos los datos en catálogo están correctos salvo error tipográfico.

APARAMENTA GAMA SOLAR



El **interruptor magnetotérmico de Gama Solar** es una solución avanzada diseñada específicamente para proteger instalaciones solares fotovoltaicas.

Este dispositivo combina protección térmica y magnética, salvaguardando los sistemas eléctricos contra sobrecargas y cortocircuitos en aplicaciones solares de corriente continua (DC)

• **Beneficios:**

- **Protección confiable:** Salvaguarda los componentes del sistema solar contra daños eléctricos.
- **Durabilidad:** Diseñado para soportar más de 1500 operaciones mecánicas, asegurando una larga vida útil.
- **Facilidad de instalación:** Su montaje en carril DIN y compatibilidad con cables de hasta 25 mm² simplifican su integración en diversas configuraciones.



MAGNETOTÉRMICOS 2P GAMA SOLAR

REF	Voltaje	Capacidad	Corriente	Precio
200S-MAG031	500V DC	10kA	6A	19,56 €
200S-MAG032	500V DC	10kA	10A	19,56 €
200S-MAG033	500V DC	10kA	16A	19,56 €
200S-MAG039	500V DC	10kA	20A	19,56 €
200S-MAG034	500V DC	10kA	25A	19,56 €
200S-MAG035	500V DC	10kA	32A	19,56 €
200S-MAG036	500V DC	10kA	40A	19,56 €
200S-MAG037	500V DC	10kA	50A	20,88 €
200S-MAG038	500V DC	10kA	63A	20,88 €



MAGNETOTÉRMICOS 4P GAMA SOLAR

REF	Voltaje	Capacidad	Corriente	Precio
400S-MAG001	1000V DC	10kA	6A	39,15 €
400S-MAG002	1000V DC	10kA	10A	39,15 €
400S-MAG003	1000V DC	10kA	16A	39,15 €
400S-MAG009	1000V DC	10kA	20A	39,15 €
400S-MAG004	1000V DC	10kA	25A	39,15 €
400S-MAG005	1000V DC	10kA	32A	39,15 €
400S-MAG006	1000V DC	10kA	40A	39,15 €
400S-MAG007	1000V DC	10kA	50A	41,82 €
400S-MAG008	1000V DC	10kA	63A	41,82 €

Es un **dispositivo de protección contra sobretensiones** diseñado para sistemas solares fotovoltaicos. Su función principal es proteger los componentes eléctricos de la instalación frente a picos de tensión causados por eventos como descargas atmosféricas o fluctuaciones en la red eléctrica.

Este protector actúa como una barrera que desvía las sobretensiones hacia tierra, evitando que alcancen y dañen los equipos sensibles del sistema solar.



PROTECTOR SOBRETENSIÓN DC SOLAR 2P

REF	PRT-007	1000V DC	20/40kA	↓	34,68 €
-----	---------	----------	---------	---	---------



PROTECTOR SOBRETENSIÓN DC SOLAR 3P

REF	PRT-008	1200V DC	20/40kA	↓	56,94 €
-----	---------	----------	---------	---	---------

Añade a tu instalación solar la pastilla medidor solar



PASTILLA MEDIDOR SOLAR ALTA PRECISIÓN 2 CANALES	WIFI	CONTR-123	59,70€
---	------	-----------	--------







* Según la nueva normativa ERP ha habido un cambio en la medición de Lúmenes y vatios, pero sigue emitiendo la misma cantidad de luz. A medida que vayan entrando los nuevos modelos con ERP se irá actualizando en catálogo y cajas de color. Puede haber variación respecto la caja del producto (comprobar en ficha técnica), todos los datos en catálogo estan correctos salvo error tipográfico.

APARATURA PROTECTORES



MAGNETOTÉRMICO CON PROTECTOR COMBINADO SOBRETENSIÓN **TRANSITORIO Y PERMANENTE**

PROTEGE TUS INSTALACIONES DE
SOBRETENSIONES Y CAIDAS DE RAYOS

2P - 3MÓDULOS

1 UDS



REF

PVPR



PRT-020	2P 16A 10KA	59,46 €
PRT-021	2P 20A 10KA	59,46 €
PRT-022	2P 25A 10KA	59,46 €
PRT-023	2P 32A 10KA	59,46 €
PRT-005	2P 40A 10KA	59,46 €
PRT-024	2P 50A 10KA	59,46 €
PRT-025	2P 63A 10KA	59,46 €

4P - 6MÓDULOS

1 UDS



REF

PVPR



PRT-014	4P 16A 10KA	114,90 €
PRT-015	4P 20A 10KA	114,90 €
PRT-016	4P 25A 10KA	114,90 €
PRT-018	4P 32A 10KA	114,90 €
PRT-006	4P 40A 10KA	114,90 €
PRT-019	4P 50A 10KA	114,90 €
PRT-017	4P 63A 10KA	114,90 €

NORMA: EN50550 / IEC61643-1 / IEC60898-1.

LVD 2014/35/EU
ROHS 2011/65/EU

- Tiempo de actuación contra sobretensiones permanentes

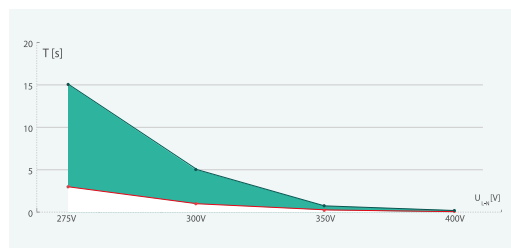

Curva de tensión / tiempo según normativa UNE-EN- 50550

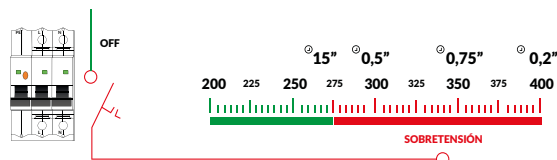
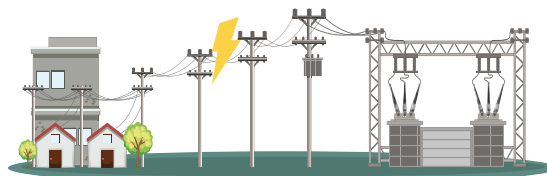

PROTECTOR DIGITAL
PERMANENTE **SOBRETENSIÓN - SUBTENSIÓN**



NEW! PRT-011 2P 63A 26,85 € 



NEW! PRT-026 4P 80A 87,09 € 

• Protector sobretensión trifásico



NEW! Protector / medidor sobretensión trifásico Tuya 

MED-004

Protector sobretensión TUYA
3P+N - 100A - 4W

PVPR 217,32 €



MAGNETOTÉRMICO PROTECTOR SOBRETENSIÓN Y SUBTENSIÓN

PERMANENTE TRANSITORIO REARMABLE

Es un interruptor general automático equipado con reconectador y protección contra sobretensión permanente y transitoria. Protege contra sobretensión, baja tensión, protección contra pérdida de tensión, protección contra pérdida de neutro, disparo por fallo de energía y función de cierre automático cuando la tensión vuelve a la normalidad. Es un IGA especial de recierre inteligente.



Magnetotérmico protector

2P - Curva C - 20-40kA 

PRT-027	25A	163,80 €
PRT-028	40A	163,80 €
PRT-029	63A	163,80 €



Magnetotérmico protector

4P - Curva C - 20-40kA

PRT-030	25A	244,14 €
PRT-031	40A	244,14 €

● Protector sobretensión transitorias

NEW!



Protector sobretensión - 2 POLOS

 2 UDS

DESCARGAR
FICHA TECNICA



PRT-009
PROTECTOR CONTRA
SOBRETENSIONES TRANSITORIAS

C2-40KA/275V 1P+NPE

PVPR 29,76 €

Protector sobretensión - 4 POLOS

 1 UDS

DESCARGAR
FICHA TECNICA



PRT-002
PROTECTOR CONTRA
SOBRETENSIONES TRANSITORIAS

C2-40KA/400V 3P+NPE

PVPR 67,89 €

● Protector sobretensión individual

Protector sobretensión individual

 1 UDS

DESCARGAR
FICHA TECNICA



NEW!

PRT-013
PROTECTOR SOBRETENSIÓN
INDIVIDUAL
Uc: 320Vac - I_{max}: 10Ka - I_n: 5Ka - IP67

PVPR 13,68 €

● Protector de voltaje individual digital con enchufe

Protector de voltaje

 1 UDS

DESCARGAR
FICHA TECNICA



NEW!

PRT-032
PROTECTOR DE VOLTAJE
3680W - 16A
Voltaje de protección regulable

PVPR 23,88 €

● Protectores

**Protector permanente
sobretensión y subtenSIón**

100-BOB003

Solo para las series
Magnetotérmico 10kA
100/000-MAG

PROTECTOR PERMANENTE BOBINA
DE MÁXIMA Y MÍNIMA 230V
para MAG 10KA

PVPR 35,94 €



 8 UDS

DESCARGAR
FICHA TECNICA



Bobina de tensión - Protección tensión max

100-BOB001

Solo para las series
Magnetotérmico 10kA
101/104-MAG

TIPO AC 230V -4M

PVPR 55,80 €

Bobina de tensión

100-BOB004

Solo para las series 108/109-MAG
para MAG 10KA

PVPR 13,38 €



INTERRUPTOR DE TRANSFERENCIA AUTOMÁTICA

Descripción del Producto

Sistema de conmutación automática de dos entradas, diseñado para trabajar con una línea principal (A) y una línea de respaldo (B). Compatible con instalaciones de corriente alterna de 50-60 Hz y con intensidades nominales de 63A.

Su función es sencilla: si se interrumpe el suministro eléctrico principal, el equipo cambia de forma automática a la fuente de reserva para que la instalación siga funcionando sin que el usuario tenga que intervenir, ideal para instalaciones solares.

El cambio se realiza en menos de 50 milisegundos, un tiempo prácticamente imperceptible, lo que evita paradas, reinicios y fallos provocados por cortes de red.



	REF	PVPR
INTERRUPTOR DE TRANSFERENCIA AUTOMÁTICA 2P 63A 230V	ATS-001	74,40€



	REF	PVPR
INTERRUPTOR DE TRANSFERENCIA AUTOMÁTICA 4P 63A 230V	ATS-401	89,55€

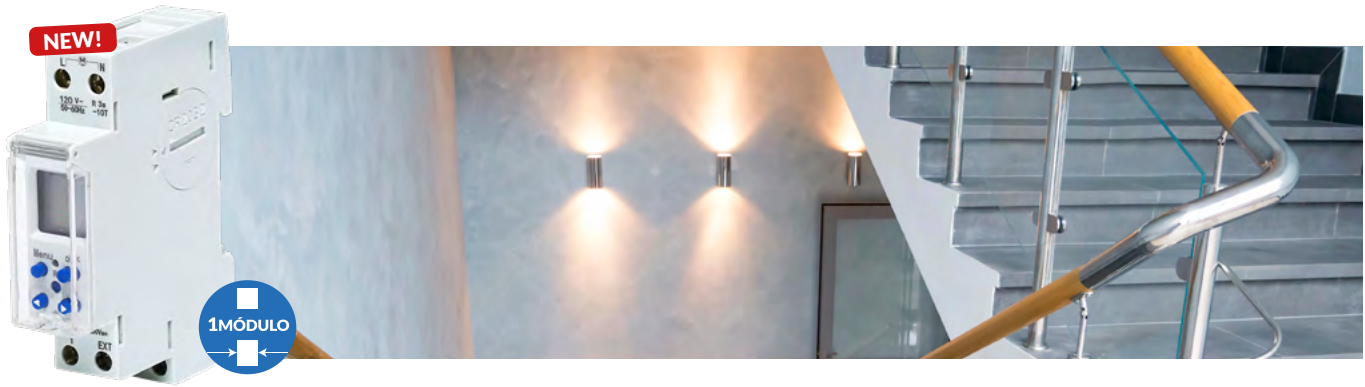

● Reloj horario

INTERRUPTOR HORARIO DIGITAL

Compatible con pila CR2032

Módulo estrecho 1 módulo

Programa tus dispositivos eléctricos con facilidad.

Es adecuado para uso particular de las siguientes tareas:

- Iluminación de áreas privadas e industriales,
- Iluminación de calles y escaparates
- Regulación de aire acondicionado
- Motores, bombas, plantas y maquinaria, así como para simular presencia, etc.

- Interruptor de disparo externo
- Programa de cuenta atrás (1s~59m59s)
- Programa diario y semanal.
- 32 programas de pulso (1s~59m59s)
- Fecha y hora preestablecidas
- 16 grupos de programa ON/OFF
- Mostrar año/mes/día/hora/minuto
- Encendido/Apagado permanente
- Totalmente operable sin conexión a la red eléctrica
- Reemplazo de batería de litio y batería recargable

	REF		PVPR
INTERRUPTOR HORARIO DIGITAL	RLJ-013	16A 230V IP20	55,50€ 



- Programación digital
- Pantalla LCD
- 8 Programas dia/semana
- 16A 3680w
- 230v 50Hz
- Carga inductiva es de 8A 1800 W

	REF		PVPR
RELOJ TEMPORIZADOR DIGITAL	RLJ-014	16A 3680w 230V	77,94€

* Según la nueva normativa ERP ha habido un cambio en la medición de Lúmenes y vatios, pero sigue emitiendo la misma cantidad de luz. A medida que vayan entrando los nuevos modelos con ERP se irá actualizando en catálogo y cajas de color. Puede haber variación respecto a la caja del producto (comprobar en ficha técnica), todos los datos en catálogo están correctos salvo error tipográfico.

● Reloj modular



Reloj modular

1 UDS

DESCARGAR
FICHA TECNICA**RLJ-001**

RELOJ MODULAR CON RESERVA

PVPR 39,57 €

● Minutero escalera



Minutero escalera

1 UDS

DESCARGAR
FICHA TECNICA**RLJ-003**

MINUTERO ESCALERA CON INDICADOR LED

PVPR 35,94 €

● Reloj modular

El reloj modular se presenta como el **programador ideal para la semana**, aplicaciones estacionarias o que necesitan variar su horario de funcionamiento a lo largo del año,...

NEW!



Reloj modular digital

RLJ-005
RELOJ CON RESERVA
1 CANAL - 16A

PVPR 49,14 €

1 UDS

Dispone de:

 Interruptor horario digital
con programa semanal

Batería de litio 3.6V, 1.2Ah

52 Programas

 Cambio automático de horario
Verano/Invierno

Pantalla LCD retroiluminada

Modo vacaciones

NEW!



Reloj modular digital

RLJ-006
RELOJ CON RESERVA
2 CANALES - 16A

PVPR 55,65 €

1 UDS

● **Reloj astronómico** 

El reloj *calcula automáticamente la hora de salida y de puesta del sol* en función de la posición geográfica en la que está ubicado. Esto nos permite ahorrar energía en tu instalación.



Reloj astronómico digital 

RLJ-009
RELOJ DIGITAL CON RESERVA
1 CANAL - 16A

PVPR 55,65 €

 1 UDS



Reloj astronómico digital 

RLJ-007
RELOJ DIGITAL CON RESERVA
2 CANALES - 16A

PVPR 63 €

 1 UDS



Reloj astronómico WiFi 

RLJ-008
RELOJ WiFi CON RESERVA
1 CANAL - 16A

PVPR 50,55 €

 1 UDS

Dispone de:

 Programador astronómico y programador anual/semanal

 Reserva de marcha 10 años (batería de litio)

 80 programas

 Tapa precintable, fácil configuración con 4 botones

 Cambio automático de horario de verano/invierno

 Pantalla LCD con retroiluminación (puede desactivarse)

 Modo vacaciones

 Modo aleatorio

2CH 2 canales puede asignarse un programa individual a cada canal

 Montaje en carril din, 2 módulos

● **Interruptor - conmutador**



Interruptor - Conmutador Carril DIN

 1 UDS

DESCARGAR 
FICHA TÉCNICA

INT-001

1P 25A

PVPR 8,85 €

● **Medidor de energía** ⚡

NEW!



Medidor de energía

 1 UDS



MED-001
Medidor de energía 1P 220V CON LUZ

PVPR 35,10 €

- Gran fiabilidad
- Peso ligero
- Pequeño volumen
- La cáscara está hecha de material ignífugo de nylon con alta resistencia al fuego y aislamiento duradero
- Instalación en carril DIN 35mm

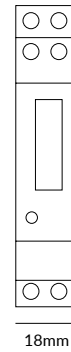

18mm

NEW!



Medidor de energía

 1 UDS

MED-003
Medidor de energía 4P 400V DIGITAL

PVPR 149,40 €

- Funciones y características
 - Montaje en carril DIN estándar de 35 mm.
 - Medición de alta precisión de la energía activa de nivel 1 y la energía reactiva de nivel 2.
 - Pantalla con retroiluminación LCD.
 - LED indica salida de pulso, salida de pulso pasiva.
 - Varios parámetros pueden consultarse rápidamente mediante las teclas.
 - Con energía bidireccional activa, medición de energía reactiva, visualización de corriente, voltaje, factor de potencia y otras funciones.

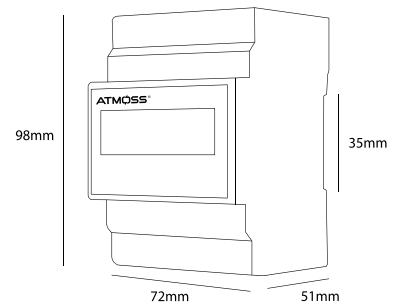

98mm

35mm

72mm

51mm

● **Contactores modular**



Contactor modular 2 POLOS

105-CON002
2P
25 A

105-CON003
2P
40 A

105-CON009
2P
63 A

PVPR 18,84 €

PVPR 33,63 €

PVPR 33,63 €

 12 UDS

 6 UDS

 6 UDS

DESCARGAR 
FICHA TECNICA



Contactor modular 4 POLOS

105-CON004
4P
25 A

105-CON005
4P
40 A

105-CON006
4P
63 A

PVPR 47,34 €

PVPR 47,34 €

PVPR 47,34 €

 6 UDS

 4 UDS

 4 UDS

DESCARGAR 
FICHA TECNICA

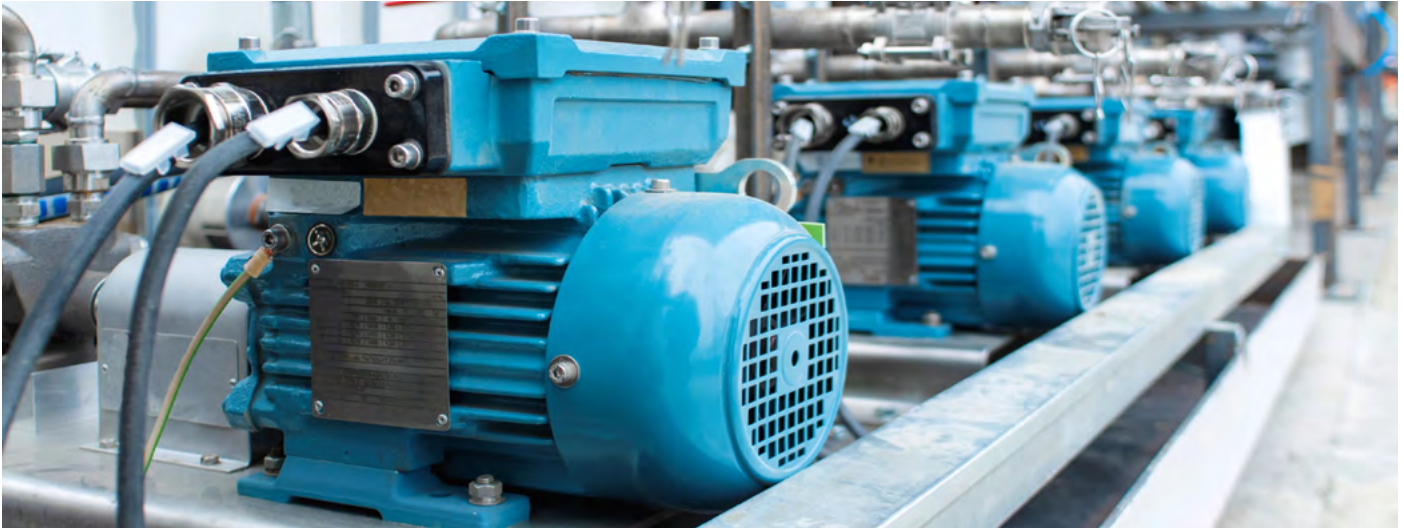

INTERRUPTOR PROTECTOR DE MOTOR

Diseñado para la protección de motores eléctricos contra sobrecargas y cortocircuitos, permitiendo también el arranque directo de motores.

- Características:

- **Seguridad y fiabilidad:** Fabricado bajo estándares IEC 60947-2/60947-4, garantiza una protección precisa y duradera.
- **Amplio rango de ajustes:** Compatible con motores que operan en rangos de corriente entre 0.1 y 32 A.
- **Versatilidad:** Admite voltajes de hasta 690 V y frecuencias de 50/60 Hz, adecuado para aplicaciones industriales y comerciales.
- **Fácil instalación:** Montaje rápido en riel DIN, con diseño compacto (77x45x44.5 mm) que optimiza el espacio.
- **Protección avanzada:** Terminales con protección IP20, evitando contactos accidentales para mayor seguridad.

- Casos de uso:

Empresas e instalaciones que buscan proteger motores eléctricos, prolongando su vida útil y evitando paradas no planificadas.



INTM-001	690V 0,63 - 1A	37,50 €
INTM-002	690V 1,0 - 1,6A	37,50 €
INTM-003	690V 1,6 - 2,5A	37,50 €
INTM-004	690V 2,5 - 4,0A	37,50 €
INTM-005	690V 4,0 - 6,3A	37,50 €
INTM-006	690V 6,0 - 10A	37,50 €
INTM-007	690V 9,0 - 14A	37,50 €
INTM-008	690V 13 - 18A	37,50 €
INTM-009	690V 17 - 23A	37,50 €
INTM-010	690V 24 - 32A	37,50 €

 1 UDS

DESCARGAR 
FICHA TECNICA

● **Fusible y portafusible**



FUS-001 *1000V DC CON LUZ 32A MÁX* 4,17 €
 Ø10 x 38mm

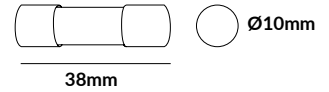

FUS-002	<i>1000V DC 16A</i>	3,30 €
FUS-003	<i>1000V DC 20A</i>	3,48 €
FUS-004	<i>1000V DC 25A</i>	3,75 €
FUS-005	<i>1000V DC 32A</i>	4,11 €

Ø10 x 38mm  10 UDS  600 UDS

Capacidad de interrupción: 20kA
 Constante de tiempo: 1-3 ms

● **Accesorios**



Base de enchufe SCHUKO  6 UDS

106-BASE001

BASE DE ENCHUFE DE CARRIL DIN SCHUKO 16A

PVPR 6,81 €

DESCARGAR 
 FICHA TECNICA

NEW!
PEINES DE CONEXIÓN

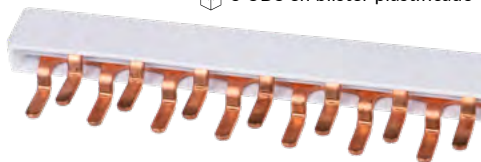

 5 UDS en blister plastificado

SOLAMENTE VÁLIDO PARA LOS MAGNETOS DPN 203-MAG

TAPAS FINALES NO INCLUIDAS

PINI-001 *1P+N 63A 108PINS* 36,48 €

Corriente (A) 63A
 Sección transversal (mm²) 10mm²
 Espesor (mm) 1,5mm

Accesorio

TAPA FINAL DE CONEXIÓN - PIN1+N 0,10€

 10 UDS

1mt longitud

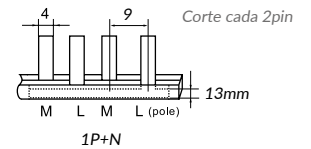

 5 UDS en blister plastificado

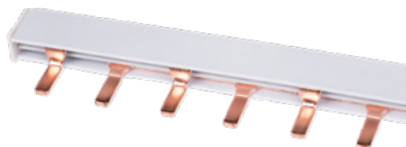

2 TAPAS FINALES INCLUIDAS

PIN2-001 *2P 63A 54PINS* 26,70 €

Corriente (A) 63A
 Sección transversal (mm²) 10mm²
 Espesor (mm) 1,5mm

Accesorio

TAPA FINAL DE CONEXIÓN - PIN2 0,09€

 10 UDS

1mt longitud

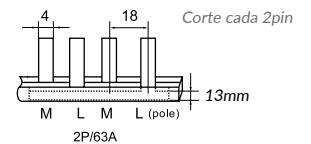

 5 UDS en blister plastificado

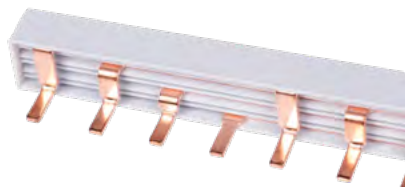

2 TAPAS FINALES INCLUIDAS

PIN4-001 *4P 63A 56PINS* 51,48 €

Corriente (A) 63A
 Sección transversal (mm²) 10mm²
 Espesor (mm) 1,5mm

Accesorio

TAPA FINAL DE CONEXIÓN - PIN4 0,14€

 10 UDS

1mt longitud

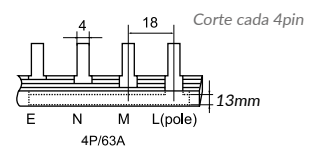



Serie apartamenta domótica

APARAMENTA DOMÓTICA

Control total de la electricidad a distancia **DESDE TU SMARTPHONE**

ON/OFF
A DISTANCIA

**APP CONTROL
REMOTO**

COMPATIBLE
CON APP **tuya**

Transforma tu espacio con tecnología inteligente y eficiente!

La apartamenta eléctrica domótica combina seguridad, eficiencia y conectividad para llevar la gestión de la electricidad a un nuevo nivel. Con soluciones inteligentes como interruptores, medidores de consumo, magnetotérmicos,... con conectividad WiFi, es posible controlar y monitorizar la instalación eléctrica de forma remota con la aplicación **tuya** optimizando el consumo y mejorando la seguridad del hogar o negocio.

Características Principales:

- **Control Remoto:** Maneja y supervisa los dispositivos desde el móvil o asistente de voz.
- **Automatización:** Inteligente: Programa encendidos y apagados según horarios o consumo.
- **Monitorización en Tiempo Real:** Accede a datos de consumo para optimizar el ahorro energético.
- **Protección Avanzada:** Magnetotérmicos y diferenciales con alertas en caso de fallos eléctricos.
- **Fácil Instalación y Configuración:** Compatible con redes WiFi y sistemas domóticos.

Beneficios:

- **Mayor Seguridad:** Previene sobrecargas y cortocircuitos con alertas en tiempo real.
- **Eficiencia Energética:** Reduce el consumo eléctrico con una gestión optimizada.
- **Confort y Comodidad:** Automatiza la iluminación y el funcionamiento de los dispositivos eléctricos.
- **Conectividad Total:** Integra tu instalación con sistemas inteligentes y plataformas IoT.

● Interruptor medidor 2P WiFi 



INT-002

Interruptor medidor Smart Wifi 2P WiFi 40A

PVPR 78,60 €

 1 UDS

INT-003

Interruptor medidor Smart Wifi 2P WiFi 63A

PVPR 78,60 €



Inicio

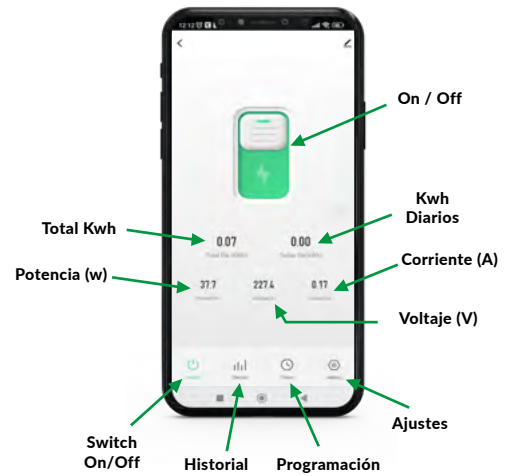

Estadísticas



Programación



Ajustes Programación

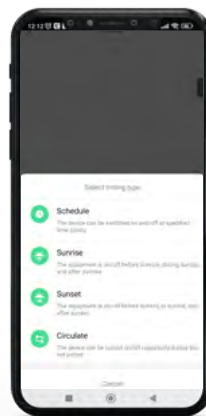

Ajustes

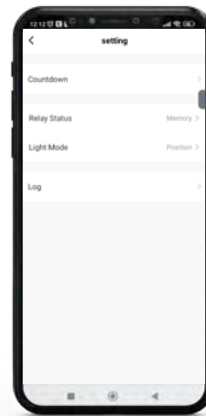

Ajustes Programación

- **Horario:** El dispositivo puede encenderse y apagarse en momentos determinados.
- **Amanecer:** El equipo se enciende/apaga antes del amanecer, durante el amanecer y después del amanecer.
- **Atardecer:** El equipo está encendido/apagado antes del atardecer, durante el atardecer y después del atardecer.
- **Circular:** El equipo puede encenderse/apagarse repetidamente durante el periodo establecido.

● Magnetotérmico Rearmable WiFi



Magnetotérmico Rearmable 

NEW!



2P - 6kA - Curva C

500-MAG001	10A	6kA	89,85 €
500-MAG002	16A	6kA	89,85 €
500-MAG003	20A	6kA	89,85 €
500-MAG004	25A	6kA	89,85 €
500-MAG005	32A	6kA	89,85 €
500-MAG006	40A	6kA	89,85 €
500-MAG008	50A	6kA	
500-MAG007	63A	6kA	91,92 €

 1 UDS



4P - 6kA - Curva C

NEW!



504-MAG007	10A	6kA	
504-MAG001	16A	6kA	113,85 €
504-MAG002	20A	6kA	113,85 €
504-MAG003	25A	6kA	113,85 €
504-MAG004	32A	6kA	113,85 €
504-MAG005	40A	6kA	113,85 €
504-MAG008	50A	6kA	
504-MAG006	63A	6kA	113,85 €

 1 UDS

Diferencial / Magnetotérmico Rearmable Super-Inmunizado Combinado VIGI 

NEW!



IP+N - Tipo A - 30mA 











500-DIF001	16A	30mA	135,12 €
500-DIF002	20A	30mA	135,12 €
500-DIF003	25A	30mA	135,12 €
500-DIF005	32A	30mA	135,12 €
500-DIF004	40A	30mA	135,12 €

 1 UDS

LA ENERGÍA EN TUS MANOS

- **Dispositivo 10 en 1**
- VIDEO VINCULACIÓN 
- ESCANEAR FICHA TÉCNICA 

Importante activar para la vinculación rápida  **Bluetooth**

-  Protección contra **SOBRETENSIÓN PERMANENTE**
-  Protección contra **BAJOVOLTAJE**
-  Protección contra **SOBREINTENSIDAD**
-  Medidor de **Kwh**
-  **Contador** de energía
-  Amperimetro
-  Protección contra **FUGAS Diferencial**
-  Interruptor **Wifi ON/OFF**
-  **Medidor** de tensión
-  Función **PREPAGO**
-  Control por **VOZ**
-  Pantalla de **visualización**



MED-002
Dispositivo de protección ajustable de tensión (PERMANENTE), corriente, y fugas con contador de kilovatios hora.

PVPR 64,29€

- El valor de **protección contra permanentes** para ajustarlo usted mismo.
- **Protección contra sobrecorriente** configurable por el usuario.
- La **protección contra fugas** la puede ajustar usted mismo.
- Visualización en **tiempo real** de la **potencia**.
- Función **prepago**.
- Control por **voz**
- Programa **horarios**
- Mide el **consumo** de tu vivienda vacacional o alquiler desde el **Check-in y Check-out**
- **Función autoencendido**. El dispositivo se restablece automáticamente.

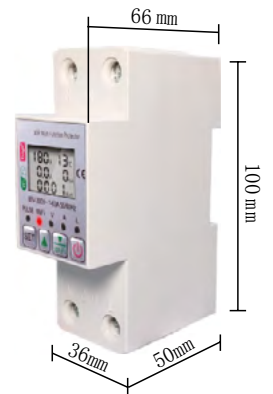





Funciones

-  Voltaje
-  **Vida** eléctrica y mecánica
-  Valor de protección contra **sobretensión**
-  Valor de protección contra **subtensión**
-  Valor de protección contra **fugas**

Parámetros técnicos

- 85-300 V
- ≤10.000 ciclos
- 120-300 V **REGULABLE**
DEFECTO 275 V
- 85-200 V **REGULABLE**
DEFECTO 160V
- 10-99m A
DEFECTO 30mA
REGULABLE

Funciones

-  **Dimensiones**
-  Valor de protección contra **sobreintensidad**
-  **Tiempo** de acción
-  **Consumo** de energía

Parámetros técnicos

- 100*36mm
- 1-63A **REGULABLE**
- <15
- <2w

FUNCIÓN PREPAGO



- Puedes controlar el consumo de tu vivienda desde tu smartphone.
- Limitar el consumo.
- Activar o desactivar la electricidad.



Uso ideal para:

- Hoteles
- Alquiler vacacional
- Alquiler vivienda
- Carga de coches
- Trasteros



Esquema eléctrico

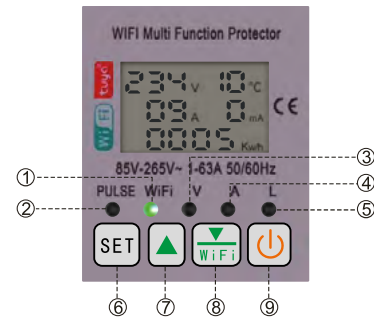
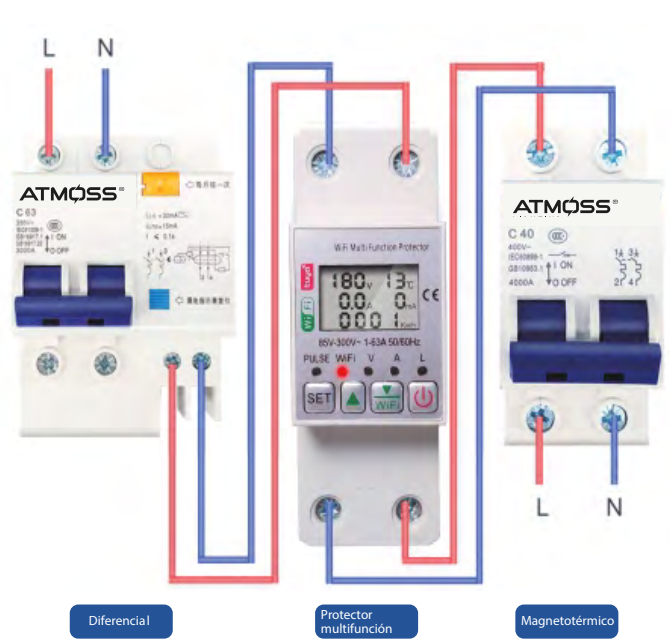

1. Indicador WIFI
2. Indicador de pulso del contador de kilovatios hora
3. Indicador de alarma de sobretensión/subtensión
4. Indicador de alarma de sobreintensidad
5. Indicador de alarma de fuga
6. Tecla Set: pulse para acceder a la interfaz de configuración
7. Tecla de ajuste +
Tecla Test: Pulsación prolongada durante 3 segundos para comprobar la fuga
8. Tecla de ajuste -
Tecla Wifi: Pulsación larga durante 5 segundos para configurar el Wifi
9. Tecla ON/OFF

Tiempo de disparo según la norma UNE-EN-5050

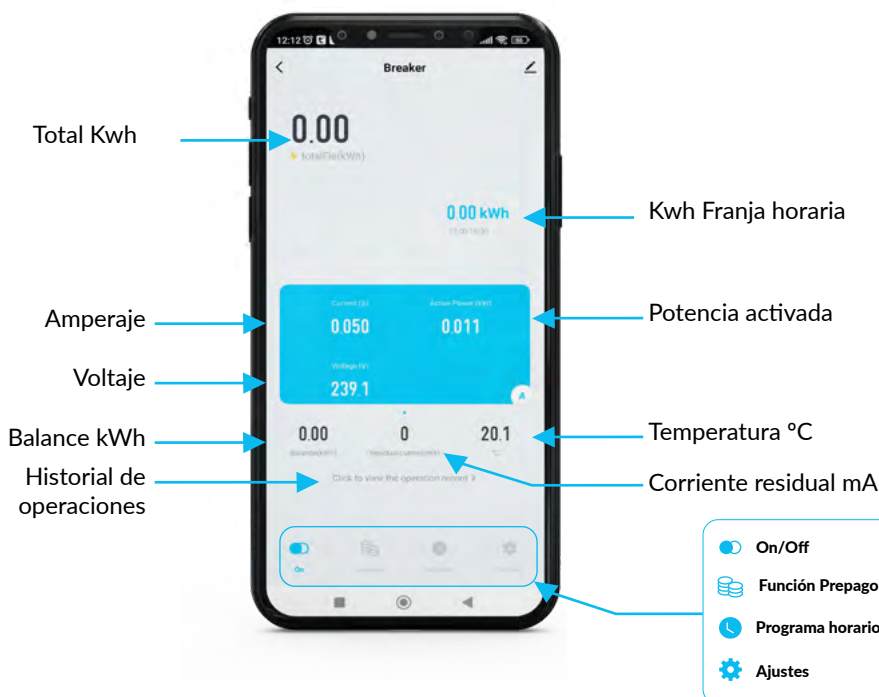
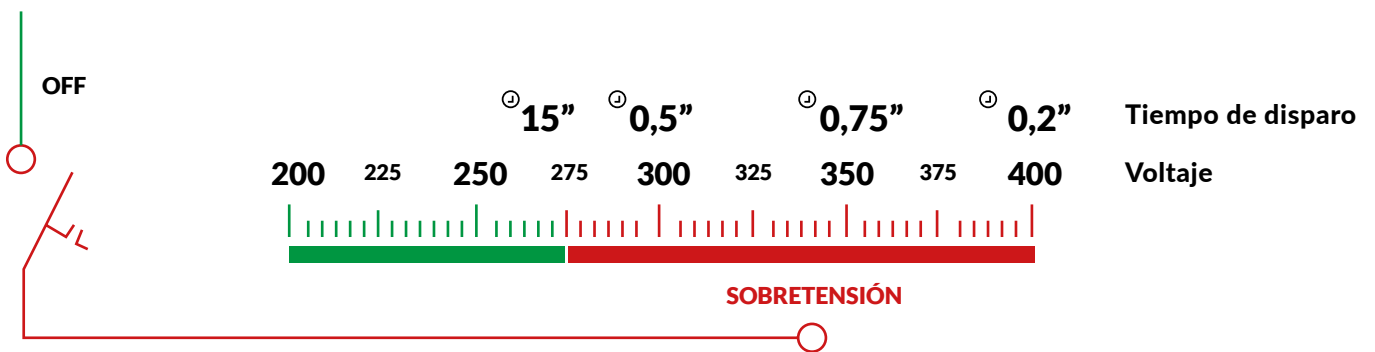

Funciones

- Consumo de potencia
- Ajusta la Temperatura
- Automatizaciones
- Programa horarios
- Monitorización energética
- Ajustar valores

* Según la nueva normativa ERP ha habido un cambio en la medición de Lúmenes y vatios, pero sigue emitiendo la misma cantidad de luz. A medida que vayan entrando los nuevos modelos con ERP se irá actualizando en catálogo y cajas de color. Puede haber variación respecto a la caja del producto (comprobar en ficha técnica), todos los datos en catálogo están correctos salvo error tipográfico.

Cajas de distribución estancas de superficie

IP65 - GRIS | IP40 - BLANCO

 1 UDS

DESCARGAR
FICHA TÉCNICA 



Color

Mantiene su color a lo largo del tiempo al aire libre

Resistencia

Gran resistencia al aire libre, gracias a su protección y material ABS. Este material destaca por sus propiedades mecánicas y su capacidad para resistir impactos.

Agrietamiento

Resiste el agrietamiento por tensión ambiental, alcoholes y muchos agentes de limpieza.

No poroso

Evita que se fijen mohos, musgos, etc en la caja.

Fácil instalación



Protección IP65

IP65 - Gris ○



BOX-001 - 3 MÓDULOS 9,12 €



BOX-004 - 12 MÓDULOS 26,10 €



BOX-002 - 5 MÓDULOS 11,46 €



BOX-005 - 18 MÓDULOS 65,70 €



BOX-003 - 8 MÓDULOS 14,58 €



BOX-006 - 24 MÓDULOS 84,42 €

IP40 - Blanco ○



BOX-007 - 6 MÓDULOS 11,85 €



BOX-010 - 16 MÓDULOS 25,74 €



BOX-008 - 8 MÓDULOS 16,02 €



BOX-011 - 24 MÓDULOS 40,50 €



BOX-009 - 12 MÓDULOS 21,54 €



BOX-012 - 36 MÓDULOS 54,48 €

Cajas de distribución estancas de superficie

Tapa transparente IP65 - Gris 



Color

Mantiene su color a lo largo del tiempo al aire libre

Resistencia

Gran resistencia al aire libre, gracias a su protección y material ABS. Este material destaca por sus propiedades mecánicas y su capacidad para resistir impactos.

Agrietamiento

Resiste el agrietamiento por tensión ambiental, alcoholes y muchos agentes de limpieza.

No poroso

Evita que se fijen mohos, musgos, etc en la caja.

• En los modelos superiores BOX-019 / 020



Apertura por palanca



Bisagra

IP65 - Gris ○



BOX-013 - 3 MÓDULOS

PVPR 9,78 €

Regleta de bornes No

Descargar Ficha técnica 



BOX-017 - 18 MÓDULOS

PVPR 56,40 €

Regleta de bornes Si

Descargar Ficha técnica 



BOX-014 - 5 MÓDULOS

PVPR 11,25 €

Regleta de bornes Si

Descargar Ficha técnica 



BOX-018 - 24 MÓDULOS

PVPR 75,30 €

Regleta de bornes Si

Descargar Ficha técnica 



BOX-015 - 8 MÓDULOS

PVPR 22,20 €

Regleta de bornes Si

Descargar Ficha técnica 



BOX-019 - 36 MÓDULOS

PVPR 157,80 €

Regleta de bornes Si

Descargar Ficha técnica 



BOX-016 - 12 MÓDULOS

PVPR 27,75 €

Regleta de bornes Si

Descargar Ficha técnica 



BOX-020 - 54 MÓDULOS

PVPR 200,70 €

Regleta de bornes Si

Descargar Ficha técnica 

Repartidor modular

Borna de distribución para carril DIN



• Conexiones

Sección de conductor (entrada/salida):
 Desde 2,5 mm² hasta 185 mm² (según modelo)
 Número de polos / orificios:
 Configuraciones variables x1, x2, x4, x5, x6
 (según referencia)
 Tipo de conexión: tornillo
 Admite punteras con estrella (Starfix ferrules)

• Materiales

Partes conductoras: Latón
 Tornillería de hierro con zincado
 Color: según muestra

• Condiciones ambientales

Temperatura de trabajo: -30 °C a +110 °C
 Tensión de aislamiento: 250-450 V

• Aplicaciones

Cuadros eléctricos de baja tensión
 Distribución de potencia
 Automatización industrial
 Instalaciones industriales y terciarias



Retardante
a la llama
94V-2



Material
Poliamida
PA66



RPM-207



RPM-211



RPM-215



RPM-407



RPM-411



RPM-415



Medidas

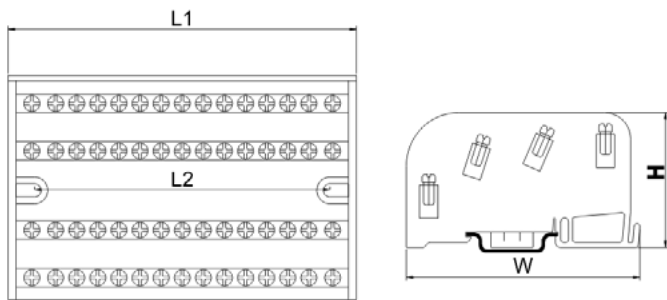

Ref	Sección (WxH)	Corriente nominal (A)	Tensión nominal (V)	L1 (mm)	L2 (mm)	H (mm)	W (mm)	Sección máx. cable	Nº de orificios	Material
207	6.5 x 12	125	500	67	48	50	45	35 mm ²	2 x 7	PA
211	6.5 x 12	125	500	100	86	50	45	35 mm ²	2 x 11	PA
215	6.5 x 12	125	500	134	118	50	45	35 mm ²	2 x 15	PA
407	6.5 x 12	125	500	67	48	50	90	35 mm ²	4 x 7	PA
411	6.5 x 12	125	500	100	86	50	90	35 mm ²	4 x 11	PA
415	6.5 x 12	125	500	134	118	50	90	35 mm ²	4 x 15	PA

				REF	PVPR
REPARTIDOR MODULAR	2-07	67*45*50	125A	RPM-207	7,05€
REPARTIDOR MODULAR	2-11	100*45*50	125A	RPM-211	10,05 €
REPARTIDOR MODULAR	2-15	134*45*50	125A	RPM-215	12,69 €
REPARTIDOR MODULAR	4-07	67*90*50	125A	RPM-407	13,41 €
REPARTIDOR MODULAR	4-11	100*90*50	125A	RPM-411	19,11 €
REPARTIDOR MODULAR	4-15	134*90*50	125A	RPM-415	24,39 €

* Según la nueva normativa ERP ha habido un cambio en la medición de Lúmenes y vatios, pero sigue emitiendo la misma cantidad de luz. A medida que vayan entrando los nuevos modelos con ERP se irá actualizando en catálogo y cajas de color. Puede haber variación respecto a la caja del producto (comprobar en ficha técnica), todos los datos en catálogo están correctos salvo error tipográfico.

POLÍTICA DE DEVOLUCIONES

No se aceptarán devoluciones de materiales transcurridos 30 días desde su compra.

Los retornos se efectuarán a portes pagados, excepto aquellos que se realicen por error de **ATMOSS S.L.**, rogando que se realicen por la misma agencia por la cual se expidieron.

Toda devolución dentro de los plazos establecidos y previamente aceptada, llevará implícito un pedido de compensación.

No se aceptará la devolución en los siguientes casos:

- A.** Materiales no fabricados o comercializados por **ATMOSS S.L**
- B.** Material en buen estado que esten descatalogados.
- C.** Materiales en buen estado que hayan sido usados con anterioridad a la devolución.
- D.** Materiales que hayan sido manipulados.
- E.** Devoluciones de productos en buen estado con malas condiciones físicas de los embalajes.
- F.** Material en buen estado cuyo suministro supera los seis meses de la fecha de facturación.
- G.** En caso de una devolución con anterioridad al plazo mencionado en el apartado F., se aplicará un 15% de depreciación al material.
- H.** Para realizar una propuesta de devolución es necesario indicar el número de factura o albarán del material que se pretende devolver.
- J.** Los productos que lleven pilas incluidas y puedan estar defectuosas por el tiempo, no se efectuará el abono.

Si el comprador acredita devolver material por fallos técnicos del mismo o mal funcionamiento, será necesaria la comprobación técnica por **ATMOSS S.L** del material o de la instalación donde estuviera montado.

- A.** El proceso de comprobación del material puede durar hasta 15 días tras su recepción.
- B.** En caso de confirmar fallo del material, se le compensará al comprador (mediante abono o sustitución gratuita del material adquirido) sin que pueda exigirse daño o perjuicios de clase alguna.

C. Si por diversos motivos, la reposición de un material ha de ser adelantada a la recepción del mismo, el albarán emitido por **ATMOSS S.L** se realizará **CON CARGO**.

- A.** El proceso de comprobación del material puede durar hasta 15 días tras su recepción.
- B.** En caso de confirmar fallo del material, se le compensará al comprador (mediante abono o sustitución gratuita del material adquirido) sin que pueda exigirse daño o perjuicios de clase alguna.

C. Si por diversos motivos, la reposición de un material ha de ser adelantada a la recepción del mismo, el albarán emitido por **ATMOSS S.L** se realizará **CON CARGO**.
Tras la verificación de las devoluciones se realizará su respectivo abono o sustitución, siempre que proceda.

Una vez superadas las 48 horas de entrega del material, **ATMOSS S.L** no aceptará reclamaciones relativas a roturas de material, errores en las cantidades o errores de modelos. En caso de notificar en el justificante de entrega por parte de la transportadora que la mercancía está sujeta a revisión, el plazo se extenderá a 7 días naturales siguientes a la fecha en la que se efectuó el suministro.

CONDICIONES DE GARANTÍA

ATMOSS S.L trabaja con fabricantes de alta calidad, y exige que todos sus productos se desarrollen con los más altos niveles de fiabilidad y eficiencia.

Los productos ofrecidos de **ATMOSS S.L**, tienen 3 años de garantía, desde la entrega de los mismos, desde la fecha de compra (fecha de factura).

La garantía de los productos vendidos por **ATMOSS S.L** se presta y establece en virtud de la normativa contenida en la LEY 23/2003, del 10 de julio, de garantías en la Venta de Bienes de Consumo, marco legal que tiene por objeto facilitar al consumidor distintas opciones.

ATMOSS S.L, aplicará la presente garantía cuando cualquier unidad no funcione o lo haga incorrectamente. El personal de **ATMOSS S.L** procedería entonces a los test pertinentes a fin de terminar las causas de tales anomalías.

ATMOSS S.L, gestionará la reposición o reparación del material en el menor plazo de tiempo posible, una vez se determine que las causas del mal funcionamiento del producto tienen su origen en la fabricación.

Siempre, el producto a reparar o sustituir, deberá corresponder al enviado por **ATMOSS S.L**. Adjuntando en el albarán de entrega y/o factura. **ATMOSS S.L** atenderá a los citados servicios por es su naturaleza como Importador y Distribuidor para todo el territorio Español.

La garantía de **ATMOSS S.L** excluye los siguientes puntos:

- El desgaste o uso indebido de horas y averías producidas por una incorrecta instalación o manipulación y almacenaje. El fallo por desgaste, uso indebido y negligencia antes o durante el uso.
- Cualquier tipo de reclamación por pérdida natural de luminosidad o degradación de luminosidad del chip led **ATMOSS S.L**, también se excluye la garantía.
- **ATMOSS S.L** no se hará cargo de posibles daños que puedan resultar por mal uso, instalación no profesional, o mal funcionamiento como corto circuito. La garantía no será válida en caso de factores externos al uso normal del producto, tales como subidas o bajadas de tensión, utilización de accesorios inadecuados o prohibidos por el fabricante, o manejo incorrecto por parte del cliente o terceras personas no autorizadas por los fabricantes.
- Esta garantía limitada no cubre defectos que ocurran debido a una instalación inapropiada de ningún tipo. **ATMOSS S.L** no cubrirá los gastos de mano de obra adicional o garantías como trabajo

asociado con reemplazos del producto. Este documento de garantía representa la única garantía expresa o implícita y no existe otro tipo de garantía.

- Otros signos de aparente trato incorrecto anularán también la presente garantía.
- Así mismo, nos reservamos el derecho a estudiar cada producto devuelto por especialistas independientes quedando la garantía exenta en caso de demostrarse por las autoridades competentes que la rotura ha sido causada por el cliente o usuario, así como la rotura parcial del producto para forzar el uso de la garantía para la devolución o reintegro del producto. En caso de ser así, los gastos para demostración de culpa correrán a cargo del cliente. Todos los aspectos de esta garantía no recogidos en esta ley 23/2003, será de aplicación el régimen contenido en la Ley 7/1996, del 15 de Enero, de Ordenación del Comercio Minorista.
- Las imágenes y descripciones de los productos **ATMOSS S.L**, son reales, salvo error tipográfico

Reclamaciones

Como consecuencia del transporte, se aceptarán en un plazo de 3 días siguientes a la recepción de la mercancía, acompañando fotocopia del albarán de la agencia de transporte en el que se consistirán la incidencia de rotura, mal estado, etc.

Toda reclamación dará lugar a un expediente de incidencia que llevará un seguimiento de las causas al objeto de realizar las oportunas acciones correctoras.

Pago de facturas

ATMOSS S.L se reserva el derecho de propiedad sobre las mercancías, incluso frente a terceros, en tanto no se cumpla íntegramente el pago del importe.

Los pagos se harán siempre efectivos en los términos pactados con el cliente. Los gastos que se originen como consecuencia de la devolución de efectos girados serán a cargo del cliente, así como los gastos financieros ocasionados por cualquier modificación.

ATMOSS S.L se reserva el derecho a suspender cualquier envío de material por impago parcial o total de algún suministro anterior.

Jurisdicción

Para toda cuestión, diferencia, interpretación, etc., que pudiera surgir, las partes se someten expresamente a la jurisdicción y competencia de los Juzgados y Tribunales de Alicante.

**Referente a las instalaciones con elementos solares
TENER EN CUENTA LAS SIGUIENTES INDICACIONES**

1- Orientación y ubicación

Se deberá tener en cuenta la orientación y ubicación de la luminaria teniendo en cuenta que la luz solar varía de acuerdo a la estación del año. Tener en cuenta árboles, edificios, cualquier elemento que produzca sombra.

2- Mantenimiento

La placa solar tendrá que tener un mantenimiento de limpieza, por lo tanto hay que tener en cuenta la accesibilidad a esta.

3- Estudio lumínico

Para grandes instalaciones se recomienda un estudio lumínico para lograr el rendimiento óptimo.

La empresa Atmoss.S.L no se hará cargo del uso indebido de estas luminarias solares.

POLÍTICA DE DEVOLUCIONES y GARANTÍA - SOLAR

Todos los productos consumibles están cubiertos por una garantía legal de dos años frente a las faltas de conformidad en virtud de lo previsto en la Ley General para la Defensa de los Consumidores y Usuarios (Real Decreto Legislativo 1/2007).

- Durante los **primeros 6 meses** el consumidor debe acreditar que existe un defecto que hace que el producto no sea conforme, se presume que el defecto es de origen o fabricación. El vendedor deberá probar que el defecto es imputable a un uso inapropiado.

- Durante los **18 meses restantes**, el consumidor debe probar que el defecto es originario y no caso fortuito, previo a la adquisición, de conformidad con las reglas generales sobre la carga de la prueba (arts. 217 y sig. LEC). Por lo tanto deberá además de aportarse el justificante de la compra, probar que ese defecto era originario (a través de un peritaje) y que ese defecto no es imputable al consumidor debido a un mal uso o el desgaste natural del producto.

No se aceptarán devoluciones de materiales transcurridos 30 días desde su compra.

La batería de Litio se considera consumible y tiene una degradación de horas con el uso del tiempo.

Los retornos se efectuarán a portes pagados, excepto aquellos que se realicen por error de ATMOSS S.L, rogando que se realicen por la misma agencia por la cual se expidieron.

Toda devolución dentro de los plazos establecidos y previamente aceptada, llevará implícito un pedido de compensación.



ATMOSS[®]



Calle los Mecánicos, 5
03130 Pol. Ind. Santa Pola (Alicante) España
Tel. +34 966 693 404 / 865 664 858

www.atmoss.es